

huscut

cutting tools

Perfect
Cut



huscut
cutting tools



ONLINE PDF
CATALOG
DOWNLOAD

Perfect
Cut



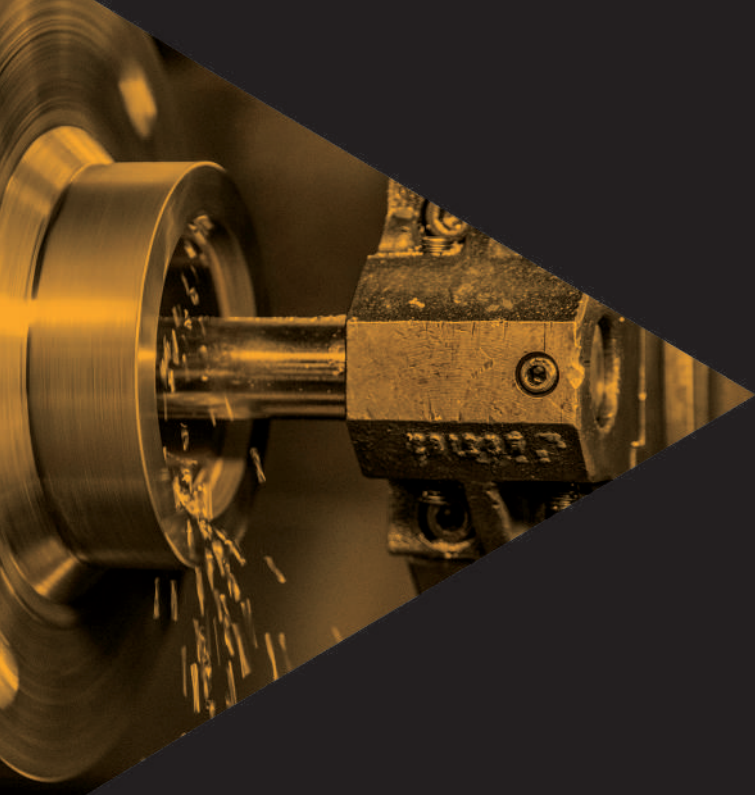

Hakkımızda About Us Über Uns

Huscut Makina İmalat San. ve Tic. Ltd. Şti. 23 yıllık tecrübeyi sanata dönüştürmek için 2019 yılında Konya'da faaliyetlerine başlamıştır.

Kurulduğu günden bu yana sürekli yeniliğe ve gelişen teknolojiye ayak uydurarak Türkiye ekonomisine katma değer sağlamak ve sektöründe ilke edindiği evrensel değerleriyle ulusal ve uluslararası alanda belirleyici marka olmak için üretim yapmaktadır.

Üretimde başarı ve sürekliliğin teminatı; "hizmette dürüstlük ve kalitedir" prensibiyle çalışan HUSCUT geçmişte olduğu gibi bugün ve gelecekte de hizmet vermeye devam edecektir.

HUSCUT bir HÜSNÜ ÖZTÜRK TEKNİK HIRDAVAT LTD. ŞTİ. Kuruluşudur...

Huscut Makina İmalat San.ve Tic. Ltd. Sti. is started its activities in Konya at 2019 to turn its 23 years of experience into art.

Since the day it was founded, Huscut Makina İmalat San.ve Tic. Ltd. Sti. has been producing in order to provide value added to the Turkish Economy by keeping up with the innovation, developing technology and to become a determining brand in the national and international arena with its universal values that has adopted as a principle in the sector.

Assurance of success and continuity in production; Working with the principle of "honesty and quality in service", HUSCUT will continue to serve today and in the future as it has in the past.

HUSCUT is a organization of HÜSNÜ ÖZTÜRK TEKNİK HIRDAVAT LTD. STI.

Huscut Makina İmalat San.ve Tic. Ltd Sti. hat seine Aktivitäten 2019 in Konya aufgenommen, um seine 23-jährige Erfahrung in Kunst umzusetzen.

Huscut Makina İmalat San. ve Tic. Ltd Sti. produziert, um der türkischen Wirtschaft einen Mehrwert zu bieten, indem es mit der Innovation Schritt hält, Technologie entwickelt und mit seinen universellen Werten, die sich als Prinzip in der Branche etabliert haben, zu einer bestimmenden Marke auf nationaler und internationaler Ebene wird.

Erfolgssicherung und Kontinuität in der Produktion; HUSCUT arbeitet nach dem Prinzip "Ehrlichkeit und Qualität im Service" und wird heute und in Zukunft weiterhin so dienen, wie es in der Vergangenheit der Fall war.

HUSCUT ist eine organisation der HÜSNÜ ÖZTÜRK TEKNİK HIRDAVAT LTD. STI.



İçindekiler

Index

Übersicht

Dış Torna Katerleri

External Turning Toolholders
Aussen - Drehhalter

8-40

Delik Torna Katerleri

Boring Bars
Bohrstange

44-72

Dış Çap Kanal Açma Takımları

External Grooving Toolholders
Außen-stechhalter

76-94

İç Çap Kanal Açma Takımları

Internal Grooving Toolholder
Innen-stechhalter

96-104

Dış Çap Dış Açma Katerleri

External Threading Toolholders
Innen-gewindedrehhalter

108-112

Pah Açma Frezeler

Chamfering End Mills
Fasfräser

116-120

Yüzey Takım Frezeleri

End Mills
Schaftfräser

122-146

Modüler Takım Frezeleri

Modular End Mills
Einschraubfräser

148-158

Yüzey Frezeleri

Face Milling
Plan-und Eckmesserköpfe

160-191

Hızlı İlerlemeli Takım Frezeleri

Highfeed End Mills
Hochvorschub- Schaftfräser

192-197

Hızlı İlerlemeli Modüler Takım Frezeleri

Modular Highfeed End Mills
Hochvorschub-einschraubfräser

198-202

Hızlı İlerlemeli Yüzey Frezeleri

High Feed Milling Tools
Hochvorschubfräser

204-208

Takma Uçlu Matkaplar

U-Drill
U-Drill









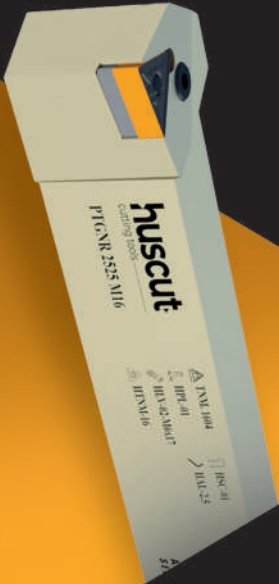

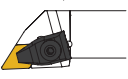



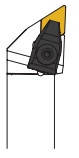
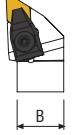
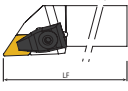
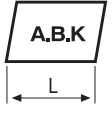





























212-230

Diş Torna Takımları

External Turning Toolholders

Aussen - Drehhalter



T	D	J	N	R	25	25	M	15
» 1	» 2	» 3	» 4	» 5	» 6	» 7	» 8	» 9
Bağlama Tipi Clamping Type Klemmsystem	Uç Tipi Type Of Insert Plattenform	Yanaşma Açısı Berthing Angle Anlegewinkel	Serbest Uç Açısı Free End Angle Freiwinkel	Kesme Yönü Cutting Direction Schnitttrichtung	Kenar Yüksekliği Edge Height Kantenhöhe	Şaft Geniřliđi Shank With Schaftbreite	Şaft Boyu Shank Length Schaftlänge	Kenar Uzunluđu Edge Length Schneidkantenlänge
								
Çektirmeli With Puller Mit Puller	C	A	A	L				A.B.K
T		B	B					C.D.E M.V
	D	D	C	N			A-32	
Baska Papuđu With Puller Mit Puller	E	E	D				B-40	
M	K	F	E				C-50	
	L	G	D				D-60	
Levyeli Lever Hebel	R	J	E	R			E-70	
P		K	F				F-80	
	S	L	G				G-90	
Vidalı Screwed Aufgeschmissen	T	M	F				H-100	
S		N	G				J-110	
	V	O	N				K-125	
Çektirmeli With Puller Mit Puller	W	P	P				L-140	
C		Y					M-150	
		Z					N-160	
	A						P-170	
							Q-180	
	B						R-200	
							S-250	
	H						T-300	
							U-350	
	M						V-400	
							W-450	
	O						X-Special	
								
	P							
								

TCBNR

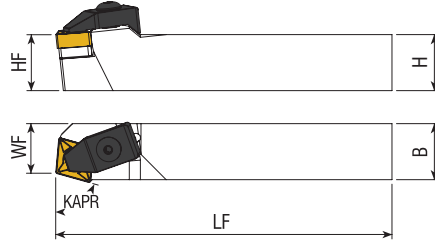
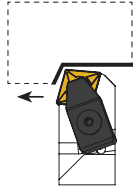

KAPR=75°

Takım Kodu Ordering Code Bestell-Bezeichnung	Takım Ölçüleri (mm) Dimension (mm) Abmessung (mm)				Kesici Uç Insert Wendeschneidplatte	Baskı Pabucu Wedge Clamp Spannpratze	Pabuç Vidası Clamp Screw Klemmschraube	Altılık Shim Unterlage	Altılık Vidası Shim Screw Schraube für Unterlage	Pul Shim Ring	Anahtar Allenkey Innensechskantschlüssel
	HF H	B	LF	WF							
TCBNR/L 2525 M12	25	25	150	20	CNM.1204	HBP-02	HPV-02-M6*22	HCNM-12	HAV-02-M5*12	HP-01	HAL-03
2525 M16	25	25	150	22	CNM.1606	HBP-04	HPV-03-M7*25	HCNM-16	HAV-05-M6*15	HP-02	HAL-04

TCKNR

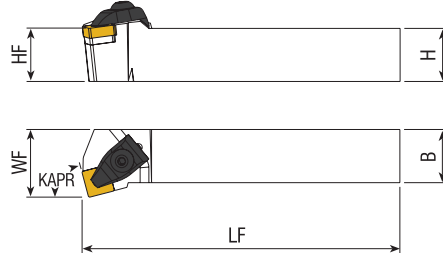
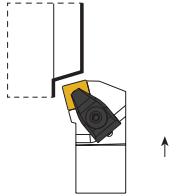

KAPR=75°

Takım Kodu Ordering Code Bestell-Bezeichnung	Takım Ölçüleri (mm) Dimension (mm) Abmessung (mm)				Kesici Uç Insert Wendeschneidplatte	Baskı Pabucu Wedge Clamp Spannpratze	Pabuç Vidası Clamp Screw Klemmschraube	Altılık Shim Unterlage	Altılık Vidası Shim Screw Schraube für Unterlage	Pul Shim Ring	Anahtar Allenkey Innensechskantschlüssel
	HF H	B	LF	WF							
TCKNR/L 2020 K12	20	20	125	25							
2525 M12	25	25	150	32	CNM.1204	HBP-02	HPV-02-M6*22	HCNM-12	HAV-02-M5*12	HP-01	HAL-03
3232 P12	32	32	170	40							
2525 M16	25	25	150	32	CNM.1606	HBP-04	HPV-03-M7*25	HCNM-16	HAV-05-M6*15	HP-02	HAL-04
3232 P16	32	32	170	40							



TCLNR

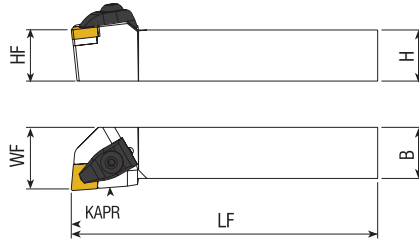
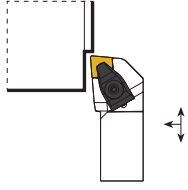

KAPR=95°

Takım Kodu Ordering Code Bestell-Bezeichnung	Takım Ölçüleri (mm) Dimension (mm) Abmessung (mm)				Kesici Uç Insert Wendeschneidplatte	Baskı Pabucu Wedge Clamp Spannpratze	Pabuç Vidası Clamp Screw Klemmschraube	Altık Shim Unterlage	Altık Vidası Shim Screw Schraube für Unterlage	Pul Shim Ring	Anahtar Allenkey Innensechskantschlüssel
	HF H	B	LF	WF							
TCLNR/L 2020 K12	20	20	125	25							
2525 M12	25	25	150	32	CNM.1204	HBP-02	HPV-02-M6*22	HCNM-12	HAV-02-M5*12	HP-01	HAL-03
3232 P12	32	32	170	40							
4040 S12	40	40	250	50							
2525 M16	25	25	150	32	CNM.1606	HBP-04	HPV-03-M7*25	HCNM-16	HAV-05-M6*15	HP-02	HAL-04
3232 P16	32	32	170	40							
4040 S16	40	40	250	50							

TCMNN

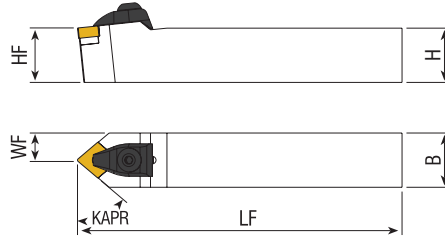
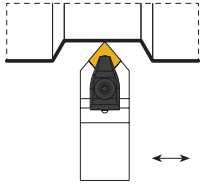

KAPR=50°

Takım Kodu Ordering Code Bestell-Bezeichnung	Takım Ölçüleri (mm) Dimension (mm) Abmessung (mm)				Kesici Uç Insert Wendeschneidplatte	Baskı Pabucu Wedge Clamp Spannpratze	Pabuç Vidası Clamp Screw Klemmschraube	Altık Shim Unterlage	Altık Vidası Shim Screw Schraube für Unterlage	Pul Shim Ring	Anahtar Allenkey Innensechskantschlüssel
	HF H	B	LF	WF							
TCMNN 1616 H12	16	16	100	8							
2020 K12	20	20	125	10	CNM.1204	HBP-02	HPV-02-M6*22	HCNM-12	HAV-02-M5*12	HP-01	HAL-03
2525 M12	25	25	150	12,5							
3232 P12	32	32	170	16							
2525 M16	25	25	150	12,5	CNM.1606	HBP-04	HPV-03-M7*25	HCNM-16	HAV-05-M6*15	HP-02	HAL-04
3232 P16	32	32	170	16							
4040 S16	40	40	250	20							

TCZNN

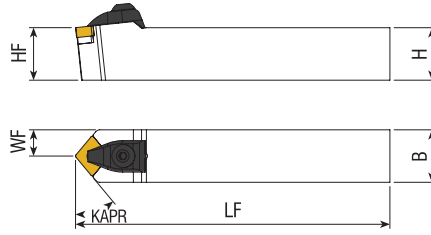
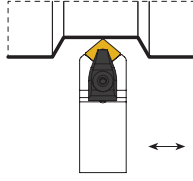

KAPR=40°

Takım Kodu Ordering Code Bestell-Bezeichnung	Takım Ölçüleri (mm) Dimension (mm) Abmessung (mm)				Kesici Uç Insert Wendeschneidplatte	Baskı Pabucu Wedge Clamp Spannpratze	Pabuç Vidası Clamp Screw Klemmschraube	Altık Shim Unterlage	Altık Vidası Shim Screw Schraube für Unterlage	Pul Shim Ring	Anahtar Allenkey Innensechskantschlüssel
	HF H	B	LF	WF							
TCZNN 2020 K12	20	20	125	10							
2525 M12	25	25	150	12,5	CNM.1204	HBP-02	HPV-02-M6*22	HCNM-12	HAV-02-M5*12	HP-01	HAL-03
3232 P12	32	32	170	16							
2525 M16	25	25	150	12,5	CNM.1606	HBP-04	HPV-03-M7*25	HCNM-16	HAV-05-M6*15	HP-02	HAL-04
3232 P16	32	32	170	16							

TDHNR

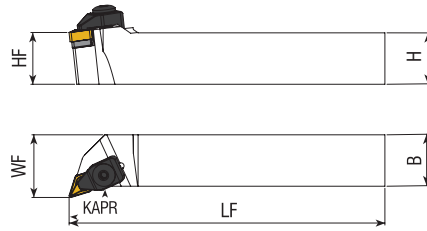
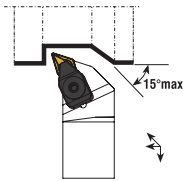

KAPR=107.5°

Takım Kodu Ordering Code Bestell-Bezeichnung	Takım Ölçüleri (mm) Dimension (mm) Abmessung (mm)				Kesici Uç Insert Wendeschneidplatte	Baskı Pabucu Wedge Clamp Spannpratze	Pabuç Vidası Clamp Screw Klemmschraube	Altık Shim Unterlage	Altık Vidası Shim Screw Schraube für Unterlage	Pul Shim Ring	Anahtar Allenkey Innensechskantschlüssel
	HF H	B	LF	WF							
TDHNR/L 2020 K11	20	20	125	24							
2525 M11	25	25	150	31	DNM.1104	HBP-01	HPV-01-M5*22	HDCM-11	HAV-03-M5*8		
2020 K15	20	20	125	25						HP-01	HAL-03
2525 M15	25	25	150	32							
3232 P15	32	32	170	40	DNM.1506	HBP-02	HPV-02-M6*22	HDNM-15	HAV-02-M5*12		
4040 S15	40	40	250	49							

TDJNR

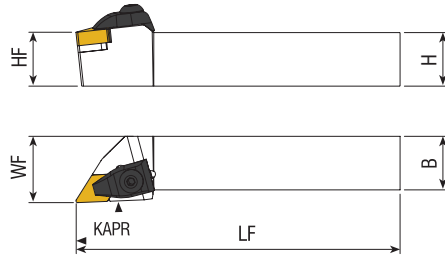
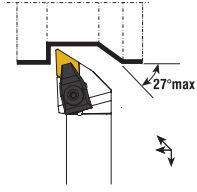

KAPR=93°

Takım Kodu Ordering Code Bestell-Bezeichnung	Takım Ölçüleri (mm) Dimension (mm) Abmessung (mm)				Kesici Uç Insert Wendeschneidplatte	Baskı Pabucu Wedge Clamp Spannpratze	Pabuç Vidası Clamp Screw Klemmschraube	Altık Shim Unterlage	Altık Vidası Shim Screw Schraube für Unterlage	Pul Shim Ring	Anahtar Allenkey Innensechskantschlüssel
	HF H	B	LF	WF							
TDJNR/L 1616 H11	16	16	100	20	DNM.1104	HBP-01	HPV-01-M5*22	HDCM-11	HAV-03-M5*8	HP-01	HAL-03
2020 K11	20	20	125	25							
2525 M11	25	25	150	32							
2020 K15	20	20	125	25	DNM.1506	HBP-02	HPV-02-M6*22	HDNM-15	HAV-02-M5*12		
2525 M15	25	25	150	32							
3232 P15	32	32	170	40							
4040 S15	40	40	250	50							
5050 S15	50	50	250	63							

TDNNN

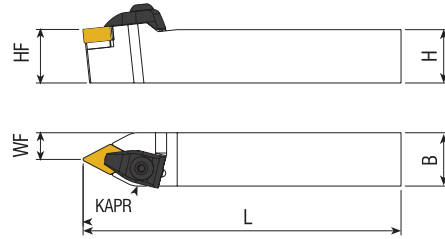
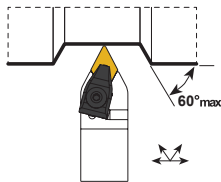

KAPR=62,5°

Takım Kodu Ordering Code Bestell-Bezeichnung	Takım Ölçüleri (mm) Dimension (mm) Abmessung (mm)				Kesici Uç Insert Wendeschneidplatte	Baskı Pabucu Wedge Clamp Spannpratze	Pabuç Vidası Clamp Screw Klemmschraube	Altık Shim Unterlage	Altık Vidası Shim Screw Schraube für Unterlage	Pul Shim Ring	Anahtar Allenkey Innensechskantschlüssel
	HF H	B	LF	WF							
TDNNN 1616 H11	16	16	100	8	DNM.1104	HBP-01	HPV-01-M5*22	HDCM-11	HAV-03-M5*8	HP-01	HAL-03
2020 K11	20	20	125	10							
2525 M11	25	25	150	12,5							
2020 K15	20	20	125	10	DNM.1506	HBP-02	HPV-02-M6*22	HDNM-15	HAV-02-M5*12		
2525 M15	25	25	150	12,5							
3232 P15	32	32	170	16							
4040 S15	40	40	250	20							
5050 S15	50	50	250	25							

Açıklama | Explanation | Erläuterung

R: Sağ / Right / Rechts L: Sol / Left / Links



Sipariş Örneği / Ordering Example / Bestellbeispiel
1 ad./pcs./stück TDJNR 2525 M15

TSDNN

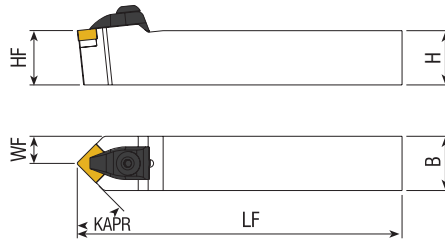
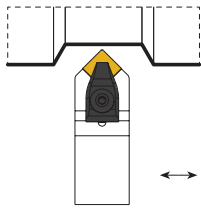

KAPR=45°

Takım Kodu Ordering Code Bestell-Bezeichnung	Takım Ölçüleri (mm) Dimension (mm) Abmessung (mm)				Kesici Uç Insert Wendeschneidplatte	Baskı Pabucu Wedge Clamp Spannpratze	Pabuç Vidası Clamp Screw Klemmschraube	Altık Shim Unterlage	Altık Vidası Shim Screw Schraube für Unterlage	Pul Shim Ring	Anahtar Allenkey Innensechskantschlüssel
	HF H	B	LF	WF							
TSDNN 1616 H12	16	16	100	8							
2020 K12	20	20	125	10	SNM.1204	HBP-02	HPV-02-M6*22	HSNM-12	HAV-02-M5*12	HP-01	HAL-03
2525 M12	25	25	150	12,5							
3232 P12	32	32	170	16							
2525 M15	25	25	150	12,5	SNM.1506	HBP-04	HPV-03-M7*25	HSNM-15	HAV-05-M6*15	HP-02	HAL-04
3232 P15	32	32	170	16							
4040 S15	40	40	250	20							

TSKNR

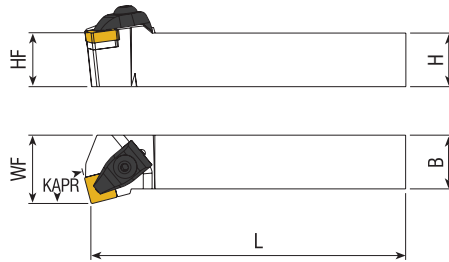
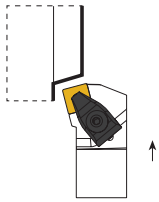

KAPR=75°

Takım Kodu Ordering Code Bestell-Bezeichnung	Takım Ölçüleri (mm) Dimension (mm) Abmessung (mm)				Kesici Uç Insert Wendeschneidplatte	Baskı Pabucu Wedge Clamp Spannpratze	Pabuç Vidası Clamp Screw Klemmschraube	Altık Shim Unterlage	Altık Vidası Shim Screw Schraube für Unterlage	Pul Shim Ring	Anahtar Allenkey Innensechskantschlüssel
	HF H	B	LF	WF							
TSKNR/L 2020 K12	20	20	125	25	SNM.1204	HBP-02	HPV-02-M6*22	HSNM-12	HAV-02-M5*12	HP-01	HAL-03
2525 M12	25	25	150	32							
3232 P12	32	32	170	40							
3232 P15	32	32	170	40	SNM.1506	HBP-04	HPV-03-M7*25	HSNM-15	HAV-05-M6*15	HP-02	HAL-04

TSSNR

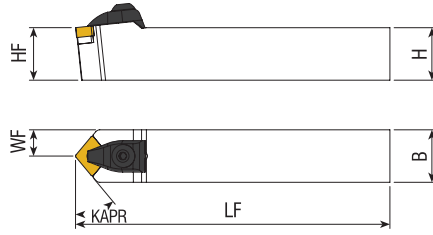
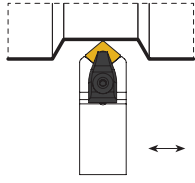

KAPR=45°



Takım Kodu Ordering Code Bestell-Bezeichnung	Takım Ölçüleri (mm) Dimension (mm) Abmessung (mm)				Kesici Uç Insert Wendeschneidplatte	Baskı Pabuçu Wedge Clamp Spannpratze	Pabuç Vidası Clamp Screw Klemmschraube	Altık Shim Unterlage	Altık Vidası Shim Screw Schraube für Unterlage	Pul Shim Ring	Anahtar Allenkey Innensechskantschlüssel
	HF H	B	LF	WF							
TSSNR/L 2020 K12	20	20	125	25							
2525 M12	25	25	150	32	SNM.1204	HBP-02	HPV-02-M6*22	HSNM-12	HAV-02-M5*12	HP-01	HAL-03
3232 P12	32	32	170	40							
2525 M15	25	25	150	32	SNM.1506	HBP-04	HPV-03-M7*25	HSNM-15	HAV-05-M6*15	HP-02	HAL-04
3232 P15	32	32	170	40							

TTENN

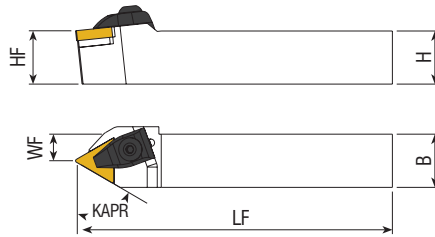
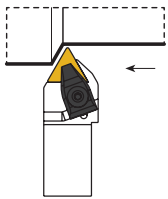

KAPR=60°



Takım Kodu Ordering Code Bestell-Bezeichnung	Takım Ölçüleri (mm) Dimension (mm) Abmessung (mm)				Kesici Uç Insert Wendeschneidplatte	Baskı Pabuçu Wedge Clamp Spannpratze	Pabuç Vidası Clamp Screw Klemmschraube	Altık Shim Unterlage	Altık Vidası Shim Screw Schraube für Unterlage	Pul Shim Ring	Anahtar Allenkey Innensechskantschlüssel
	HF H	B	LF	WF							
TTENN 2020 K16	20	20	125	10							
2525 M16	25	25	150	12.5	TNM.1604	HBP-01	HPV-01-M5*22	HTNM-16	HAV-06-M5*12		
3232 P16	32	32	170	16							
2525 M22	25	25	150	12.5						HP-01	
3232 P22	32	32	170	16	TNM.2204	HBP-02	HPV-02-M6*22	HTNM-22	HAV-02-M5*12		HAL-03
4040 S22	40	40	250	20							

TTGNR

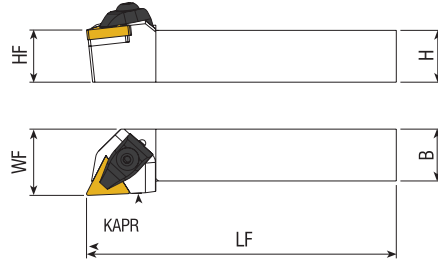
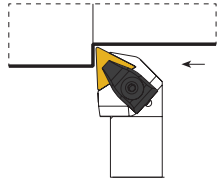

KAPR=90°



Takım Kodu Ordering Code Bestell-Bezeichnung	Takım Ölçüleri (mm) Dimension (mm) Abmessung (mm)				Kesici Uç Insert Wendeschneidplatte	Baskı Pabucu Wedge Clamp Spannpratze	Pabuç Vidası Clamp Screw Klemmschraube	Altık Shim Unterlage	Altık Vidası Shim Screw Schraube für Unterlage	Pul Shim Ring	Anahtar Allenkey Innensechskantschlüssel
	HF H	B	LF	WF							
TTGNR/L 2020 K16	20	20	125	25							
2525 M16	25	25	150	32	TNM.1604	HBP-01	HPV-01-M5*22	HTNM-16	HAV-06-M5*12		
3232 P16	32	32	170	40						HP-01	HAL-03
2525 M22	25	25	150	32							
3232 P22	32	32	170	40	TNM.2204	HBP-02	HPV-02-M6*22	HTNM-22	HAV-02-M5*12		
4040 S22	40	40	250	50							

TTJNR

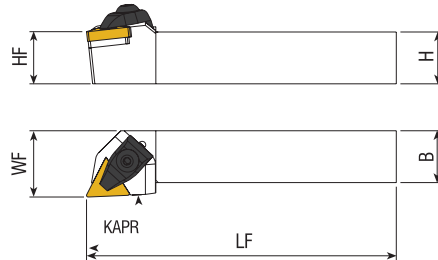
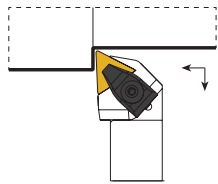

KAPR=93°



Takım Kodu Ordering Code Bestell-Bezeichnung	Takım Ölçüleri (mm) Dimension (mm) Abmessung (mm)				Kesici Uç Insert Wendeschneidplatte	Baskı Pabucu Wedge Clamp Spannpratze	Pabuç Vidası Clamp Screw Klemmschraube	Altık Shim Unterlage	Altık Vidası Shim Screw Schraube für Unterlage	Pul Shim Ring	Anahtar Allenkey Innensechskantschlüssel
	HF H	B	LF	WF							
TTJNR/L 2020 K16	20	20	125	25							
2525 M16	25	25	150	32	TNM.1604	HBP-01	HPV-01-M5*22	HTNM-16	HAV-06-M5*12		
3232 P16	32	32	170	40						HP-01	HAL-03
2525 M22	25	25	150	32							
3232 P22	32	32	170	40	TNM.2204	HBP-02	HPV-02-M6*22	HTNM-22	HAV-02-M5*12		
4040 S22	40	40	250	20							

TVHNR

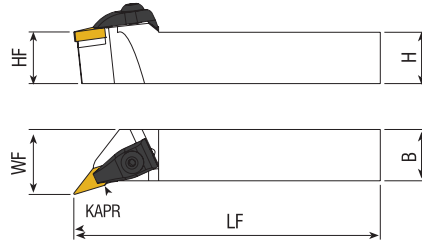
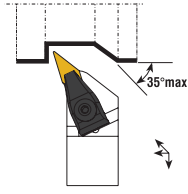

KAPR=107,5°



Takım Kodu Ordering Code Bestell-Bezeichnung	Takım Ölçüleri (mm) Dimension (mm) Abmessung (mm)				Kesici Uç Insert Wendeschneidplatte	Baskı Pabucu Wedge Clamp Spannpratze	Pabuç Vidası Clamp Screw Klemmschraube	Altık Shim Unterlage	Altık Vidası Shim Screw Schraube für Unterlage	Pul Shim Ring	Anahtar Allenkey Innensechskantschlüssel
	HF H	B	LF	WF							
TVHNR/L 2020 K16	20	20	125	25							
2525 M16	25	25	150	32	VNM.1604	HBP-03	HPV-02-M6*22	HVBM-16	HAV-03-M5*8	HP-01	HAL-03
3232 P16	32	32	170	40							

TVJNR

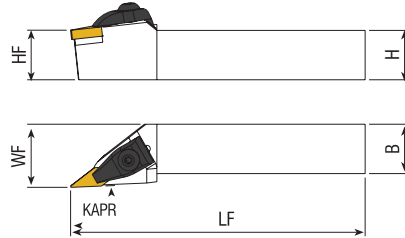
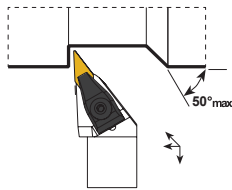

KAPR=93°



Takım Kodu Ordering Code Bestell-Bezeichnung	Takım Ölçüleri (mm) Dimension (mm) Abmessung (mm)				Kesici Uç Insert Wendeschneidplatte	Baskı Pabucu Wedge Clamp Spannpratze	Pabuç Vidası Clamp Screw Klemmschraube	Altık Shim Unterlage	Altık Vidası Shim Screw Schraube für Unterlage	Pul Shim Ring	Anahtar Allenkey Innensechskantschlüssel
	HF H	B	LF	WF							
TVJNR/L 2020 K16	20	20	125	25							
2525 M16	25	25	150	32	VNM.1604	HBP-03	HPV-02-M6*22	HVBM-16	HAV-03-M5*8	HP-01	HAL-03
3232 P16	32	32	170	40							

TVVNN

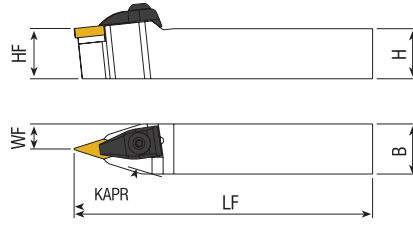
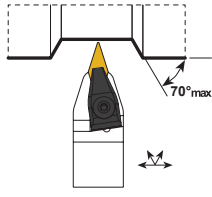

KAPR=72,5°



Takım Kodu Ordering Code Bestell-Bezeichnung	Takım Ölçüleri (mm) Dimension (mm) Abmessung (mm)				Kesici Uç Insert Wendeschneidplatte	Baskı Pabucu Wedge Clamp Spannpratze	Pabuç Vidası Clamp Screw Klemmschraube	Altık Shim Unterlage	Altık Vidası Shim Screw Schraube für Unterlage	Pul Shim Ring	Anahtar Allenkey Innensechskantschlüssel
	HF H	B	LF	WF							
TVVNN/2020 K16	20	20	125	10							
2525 M16	25	25	150	12,5	VNM.1604	HBP-03	HPV-02-M6*22	HVBM-16	HAV-03-M5*8	HP-01	HAL-03
3232 P16	32	32	170	16							

TWLNR

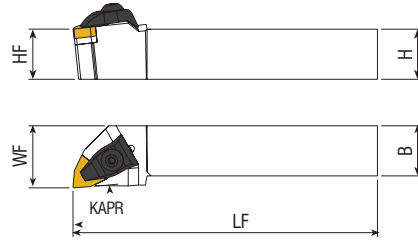
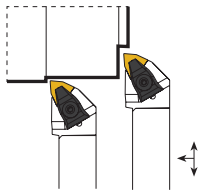

KAPR=95°



Takım Kodu Ordering Code Bestell-Bezeichnung	Takım Ölçüleri (mm) Dimension (mm) Abmessung (mm)				Kesici Uç Insert Wendeschneidplatte	Baskı Pabucu Wedge Clamp Spannpratze	Pabuç Vidası Clamp Screw Klemmschraube	Altık Shim Unterlage	Altık Vidası Shim Screw Schraube für Unterlage	Pul Shim Ring	Anahtar Allenkey Innensechskantschlüssel
	HF H	B	LF	WF							
TWLNR/L 1616 H06	16	16	100	20							
2020 K06	20	20	125	25	WNM.0604	HBP-01	HPV-01-M5*22	HWNM-06	HAV-01-M3*10		
2525 M06	25	25	150	32							
2020 K08	20	20	125	25							
2525 M08	25	25	150	32						HP-01	HAL-03
3232 P08	32	32	170	40	WNM.0804	HBP-02	HPV-02-M6*22	HWNM-08	HAV-02-M5*12		
4040 S08	40	40	250	50							
5050 S08	50	50	250	63							

PCBNR

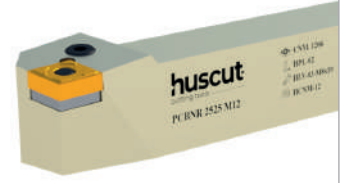
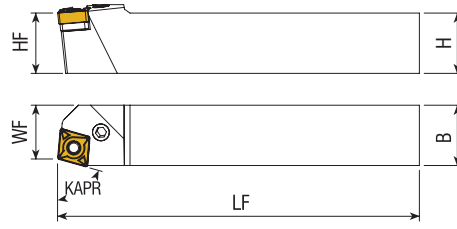
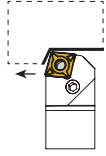

KAPR=75°

Takım Kodu Ordering Code Bestell-Bezeichnung	Takım Ölçüleri (mm) Dimension (mm) Abmessung (mm)				Kesici Uç Insert Wendeschneidplatte	Levyeye Lever Kniehebel	Levyeye Vidası Lever Screw Kniehebelschraube	Altılık Shim Unterlage	Altılık Yayı Shim Spring Feder für Unterlage	Anahtar Allenkey Innensechskantschlüssel
	HF H	B	LF	WF						
PCBNR/L 2020 K12	20	20	125	17,5						
2525 M12	25	25	150	22,5	CNM.1204	HPL-03	HLV-05-M8x19	HCNM-12	HSC-03	HAL-03
3232 P12	32	32	170	29,5						
2525 M16	25	25	150	22	CNM.1606	HPL-05	HLV-06-M8x22	HCNM-16	HSC-04	HAL-03
3232 P16	32	32	170	27						
3232 P19	32	32	170	27						
4040 S19	40	40	250	37	CNM.1906	HPL-06	HLV-07-M10x27	HCNM-19	HSC-05	HAL-05

PCMNN

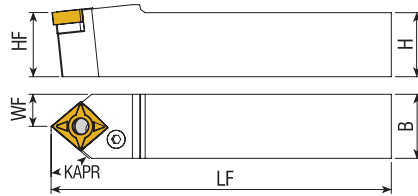
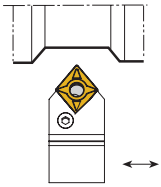

KAPR=50°

Takım Kodu Ordering Code Bestell-Bezeichnung	Takım Ölçüleri (mm) Dimension (mm) Abmessung (mm)				Kesici Uç Insert Wendeschneidplatte	Levyeye Lever Kniehebel	Levyeye Vidası Lever Screw Kniehebelschraube	Altılık Shim Unterlage	Altılık Yayı Shim Spring Feder für Unterlage	Anahtar Allenkey Innensechskantschlüssel
	HF H	B	LF	WF						
PCMNN 2020 K12	20	20	125	10						
2525 M12	25	25	150	12,5	CNM.1204	HPL-03	HLV-05-M8x19	HCNM-12	HSC-03	HAL-03
3232 P12	32	32	170	16						
2525 M16	25	25	150	12,5	CNM.1606	HPL-05	HLV-06-M8x22	HCNM-16	HSC-04	HAL-03
3232 P16	32	32	170	16						
3232 P19	32	32	170	16						
4040 S19	40	40	250	20	CNM.1906	HPL-06	HLV-07-M10x27	HCNM-19	HSC-05	HAL-04



PCLNR

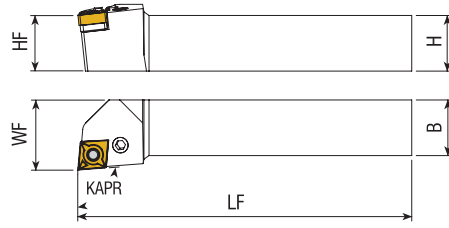
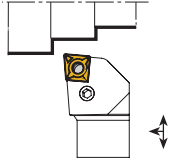

KAPR=95°

Takım Kodu Ordering Code Bestell-Bezeichnung	Takım Ölçüleri (mm) Dimension (mm) Abmessung (mm)				Kesici Uç Insert Wendeschneidplatte	Leyve Lever Kniehebel	Leyve Vidası Lever Screw Kniehebelschraube	Altılık Shim Unterlage	Altılık Yayı Shim Spring Feder für Unterlage	Anahtar Allenkey Innensechskantschlüssel
	HF H	B	LF	WF						
PCLNR/L 2020 K12	20	20	125	25						
2525 M12	25	25	150	32	CNM.1204	HPL-03	HLV-05-M8x19	HCNM-12	HSC-03	
3232 P12	32	32	170	40						HAL-03
2525 M16	25	25	150	32	CNM.1606	HPL-05	HLV-06-M8x22	HCNM-16	HSC-04	
3232 P16	32	32	170	40						
2525 M19	25	25	150	32	CNM.1906	HPL-06	HLV-07-M10x27	HCNM-19	HSC-05	
3232 P19	32	32	170	40						HAL-04
4040 S19	40	40	250	50						

PDJNR

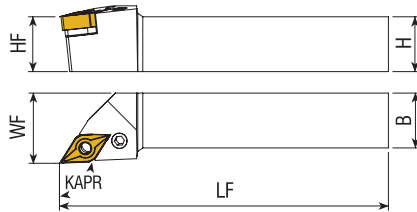
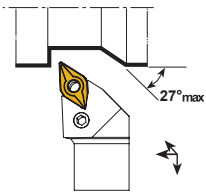







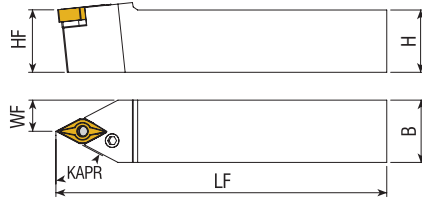
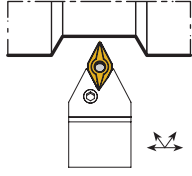











KAPR=93°

Takım Kodu Ordering Code Bestell-Bezeichnung	Takım Ölçüleri (mm) Dimension (mm) Abmessung (mm)				Kesici Uç Insert Wendeschneidplatte	Leyve Lever Kniehebel	Leyve Vidası Lever Screw Kniehebelschraube	Altılık Shim Unterlage	Altılık Yayı Shim Spring Feder für Unterlage	Anahtar Allenkey Innensechskantschlüssel
	HF H	B	LF	WF						
PDJNR/L 1616 H11	16	16	100	20						
2020 K11	20	20	125	25	DNM.1104	HPL-02	HLV-03-M6x17	HDCM-11	HSC-02	HAL-2.5
2525 M11	25	25	150	32						
2020 K15	20	20	125	25						
2525 M15	25	25	150	32	DNM.1506	HPL-04	HLV-05-M8x19	HDNM-15	HSC-03	HAL-03
3232 P15	32	32	170	40						
4040 S15	40	40	250	50						

PDNNN









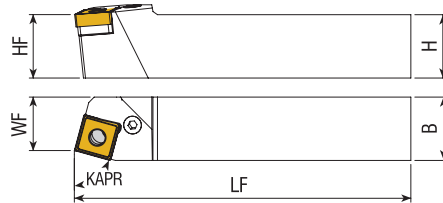
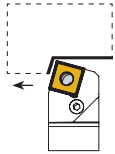



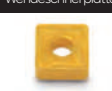





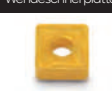

KAPR=62,5°

 Takım Kodu Ordering Code Bestell-Bezeichnung	Takım Ölçüleri (mm) Dimension (mm) Abmessung (mm)				Kesici Uç Insert Wendschnei-platte	Levyeye Lever Kniehebel	Levyeye Vidası Lever Screw Kniehebelschraube	Altılık Shim Unterlage	Altılık Yayı Shim Spring Feder für Unterlage	Anahtar Allenkey Innensechskantschlüssel
	HF H	B	LF	WF						
PDNNN 1616 H11	16	16	100	8	 DNM.1104	 HPL-02	 HLV-03-M6x17	 HDCM-11	 HSC-02	 HAL-2.5
2020 K11	20	20	125	10						
2525 M11	25	25	150	12.5	 DNM.1506	 HPL-04	 HLV-05-M8x19	 HDNM-15	 HSC-03	 HAL-03
2020 K15	20	20	125	10						
2525 M15	25	25	150	12.5						
3232 P15	32	32	170	16						

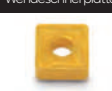
PSBNR



KAPR=75°

 Takım Kodu Ordering Code Bestell-Bezeichnung	Takım Ölçüleri (mm) Dimension (mm) Abmessung (mm)				Kesici Uç Insert Wendschnei-platte	Levyeye Lever Kniehebel	Levyeye Vidası Lever Screw Kniehebelschraube	Altılık Shim Unterlage	Altılık Yayı Shim Spring Feder für Unterlage	Anahtar Allenkey Innensechskantschlüssel
	HF H	B	LF	WF						
PSBNR/L 2020 K12	20	20	125	17	 SNM.1204	 HPL-03	 HLV-05-M8x19	 HSNM-12	 HSC-03	 HAL-03
2525 M12	25	25	150	22						
3232 P12	32	32	170	27						
2525 M15	25	25	150	22	 SNM.1506	 HPL-05	 HLV-06-M8x22	 HSNM-15	 HSC-04	 HAL-03
3232 P15	32	32	170	27						

PSDNN

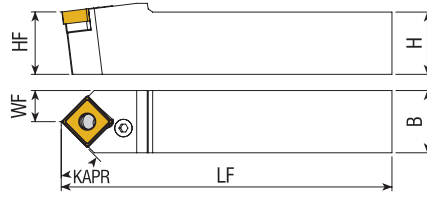
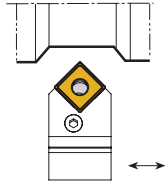

KAPR=45°

Takım Kodu Ordering Code Bestell-Bezeichnung	Takım Ölçüleri (mm) Dimension (mm) Abmessung (mm)				Kesici Uç Insert Wendeschneidplatte	Levyeye Lever Kniehebel	Levyeye Vidası Lever Screw Kniehebelschraube	Altılık Shim Unterlage	Altılık Yayı Shim Spring Feder für Unterlage	Anahtar Allenkey Innensechskantschlüssel
	HF H	B	LF	WF						
PSDNN/2020 K12	20	20	125	10						
2525 M12	25	25	150	12.5	SNM.1204	HPL-03	HLV-05-M8x19	HSNM-12	HSC-03	
3232 P12	32	32	170	16						HAL-03
2020 K15	20	20	125	10	SNM.1506	HPL-05	HLV-06-M8x22	HSNM-15	HSC-04	
2525 M15	25	25	150	12.5						

PSSNR

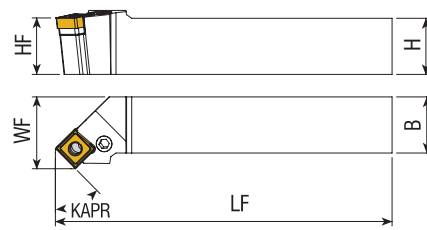
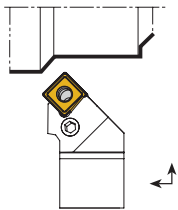







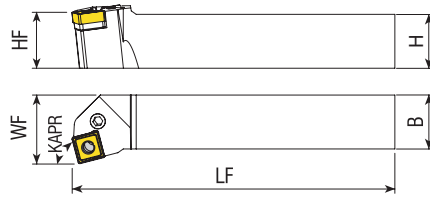
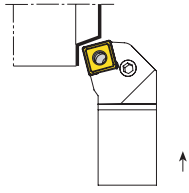











KAPR=45°

Takım Kodu Ordering Code Bestell-Bezeichnung	Takım Ölçüleri (mm) Dimension (mm) Abmessung (mm)				Kesici Uç Insert Wendeschneidplatte	Levyeye Lever Kniehebel	Levyeye Vidası Lever Screw Kniehebelschraube	Altılık Shim Unterlage	Altılık Yayı Shim Spring Feder für Unterlage	Anahtar Allenkey Innensechskantschlüssel
	HF H	B	LF	WF						
PSSNR/L 2020 K12	20	20	125	25						
2525 M12	25	25	150	32	SNM.1204	HPL-03	HLV-05-M8x19	HSNM-12	HSC-03	
3232 P12	32	32	170	40						HAL-03
3232 P15	32	32	170	40	SNM.1506	HPL-05	HLV-06-M8x22	HSNM-15	HSC-04	

PSKNR









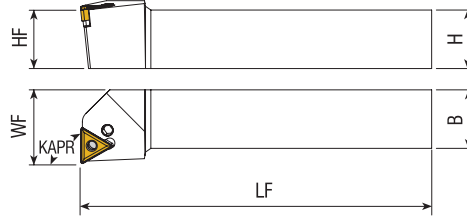
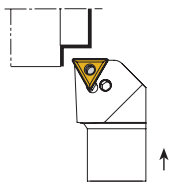











KAPR=75°

 Takım Kodu Ordering Code Bestell-Bezeichnung	Takım Ölçüleri (mm) Dimension (mm) Abmessung (mm)				Kesici Uç Insert Wendeschneidplatte	Leyve Lever Kniehebel	Leyve Vidası Lever Screw Kniehebelschraube	Altlık Shim Unterlage	Altlık Yayı Shim Spring Feder für Unterlage	Anahtar Allenkey Innensechskantschlüssel					
	HF H	B	LF	WF											
PSKNR/L 2020 K12	20	20	125	25											
2525 M12	25	25	150	32							SNM.1204	HPL-03	HLV-05-M8x19	HSNM-12	HSC-03
3232 P12	32	32	170	40											
2525 M15	25	25	150	32											
3232 P15	32	32	170	40							SNM.1506	HPL-05	HLV-06-M8x22	HSNM-15	HSC-04

PTFNR



KAPR=90°

 Takım Kodu Ordering Code Bestell-Bezeichnung	Takım Ölçüleri (mm) Dimension (mm) Abmessung (mm)				Kesici Uç Insert Wendeschneidplatte	Leyve Lever Kniehebel	Leyve Vidası Lever Screw Kniehebelschraube	Altlık Shim Unterlage	Altlık Yayı Shim Spring Feder für Unterlage	Anahtar Allenkey Innensechskantschlüssel					
	HF H	B	LF	WF											
PTFNR/L 1616 H16	16	16	100	20											
2020 K16	20	20	125	25							TNM.1604	HPL-02	HLV-03-M6x17	HTNM-16	HSC-02
2525 M16	25	25	150	32											
3232 P16	32	32	170	40											
2525 M22	25	25	150	32											
3232 P22	32	32	170	40							TNM.2204	HPL-03	HLV-05-M8x19	HTNM-22	HSC-03

PTG NR

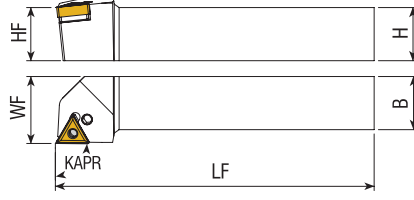
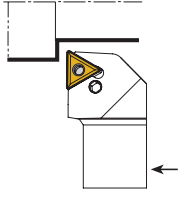

KAPR=90°

Takım Kodu Ordering Code Bestell-Bezeichnung	Takım Ölçüleri (mm) Dimension (mm) Abmessung (mm)				Kesici Uç Insert Wendeschneidplatte	Levye Lever Kniehebel	Levye Vidası Lever Screw Kniehebelschraube	Altılık Shim Unterlage	Altılık Yayı Shim Spring Feder für Unterlage	Anahtar Allenkey Innensechskantschlüssel
	HF H	B	LF	WF						
PTG NR/L1616 H16	16	16	100	20	TNM.1604	HPL-02	HLV-03-M6x17	HTNM-16	HSC-02	HAL-2.5
2020 K16	20	20	125	25						
2525 M16	25	25	150	32						
3232 P16	32	32	170	40						
2525 M22	25	25	150	32	TNM.2204	HPL-03	HLV-05-M8x19	HTNM-22	HSC-03	HAL-03
3232 P22	32	32	170	40						

PTJ NR

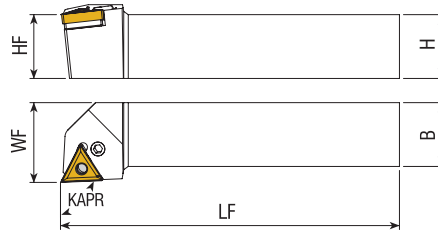
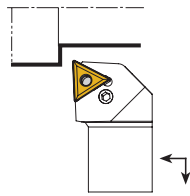

KAPR=93°

Takım Kodu Ordering Code Bestell-Bezeichnung	Takım Ölçüleri (mm) Dimension (mm) Abmessung (mm)				Kesici Uç Insert Wendeschneidplatte	Levye Lever Kniehebel	Levye Vidası Lever Screw Kniehebelschraube	Altılık Shim Unterlage	Altılık Yayı Shim Spring Feder für Unterlage	Anahtar Allenkey Innensechskantschlüssel
	HF H	B	LF	WF						
PTJ NR/L 1616 H16	16	16	100	20	TNM.1604	HPL-02	HLV-03-M6x17	HTNM-16	HSC-02	HAL-2.5
2020 K16	20	20	125	25						
2525 M16	25	25	150	32						
3232 P16	32	32	170	40						
2525 M22	25	25	150	32	TNM.2204	HPL-03	HLV-05-M8x19	HTNM-22	HSC-03	HAL-03
3232 P22	32	32	170	40						

PTTNR

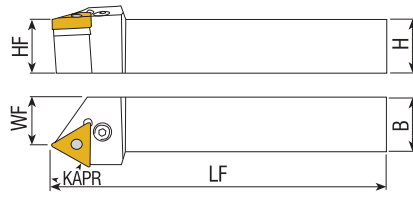
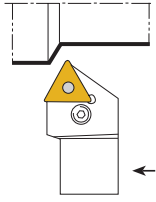

KAPR=60°

Takım Kodu Ordering Code Bestell-Bezeichnung	Takım Ölçüleri (mm) Dimension (mm) Abmessung (mm)				Kesici Uç Insert Wendeschneidplatte	Levye Lever Kniehebel	Levye Vidası Lever Screw Kniehebelschraube	Altlık Shim Unterlage	Altlık Yayı Shim Spring Feder für Unterlage	Anahtar Allenkey Innensechskantschlüssel
	HF H	B	LF	WF						
PTTNR/L 1616 H16	16	16	100	13			HLV-03-M6x17			HAL-2.5
2020 K16	20	20	125	17						
2525 M16	25	25	150	21.5						
3232 P16	32	32	170	31						
2525 M22	25	25	150	20.5		HPL-03	HLV-05-M8x19			HAL-03
3232 P22	32	32	170	29						

PWLNR

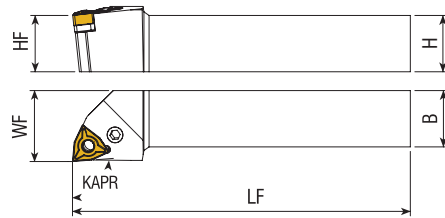
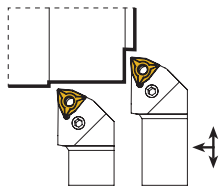

KAPR=95°

Takım Kodu Ordering Code Bestell-Bezeichnung	Takım Ölçüleri (mm) Dimension (mm) Abmessung (mm)				Kesici Uç Insert Wendeschneidplatte	Levye Lever Kniehebel	Levye Vidası Lever Screw Kniehebelschraube	Altlık Shim Unterlage	Altlık Yayı Shim Spring Feder für Unterlage	Anahtar Allenkey Innensechskantschlüssel
	HF H	B	LF	WF						
PWLNR/L 1616 H06	16	16	100	20			HLV-03M6x17			HAL-2.5
2020 K06	20	20	125	25						
2525 M06	25	25	150	32						
3232 P06	32	32	170	40						
1616 H08	16	16	100	20			HLV-05-M8x19			HAL-03
2020 K08	20	20	125	25						
2525 M08	25	25	150	32						
5050 S25	32	32	170	40						

MTENN

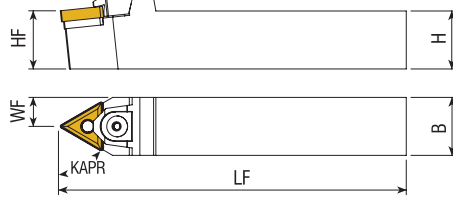
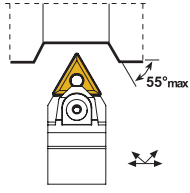

KAPR=60°



Takım Kodu Ordering Code Bestell-Bezeichnung	Takım Ölçüleri (mm) Dimension (mm) Abmessung (mm)				Kesici Uç Insert Wendeschneidplatte	Baskı Pabuçu Wedge Clamp Spannpratze	Pabuç Vidası Clamp Screw Klemmschraube	Altık Shim Unterlege	Pim Pin Stift	Pul Shim Ring	Anahtar Allenkey Innensechskantschlüssel
	HF H	B	LF	WF							
MTENN/2020 K16	20	20	125	10	TNM.1604	HBP-08	HPV-02- M6x22	HTNM-16	HPM-01	HP-01	HAL-03
2525 M16	25	25	150	12,5							
3232 P16	32	32	170	16							
2525 M22	25	25	150	12,5	TNM.2204			HTNM-22	HPM-02		
3232 P22	32	32	170	16							
4040 S22	40	40	250	20							

MTJNR

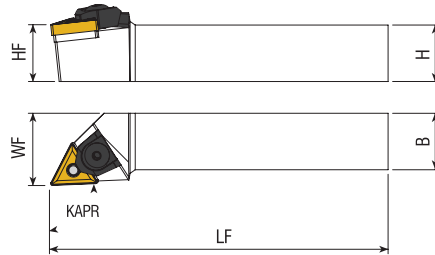
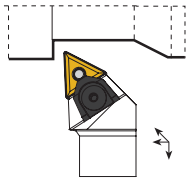

KAPR=93°



Takım Kodu Ordering Code Bestell-Bezeichnung	Takım Ölçüleri (mm) Dimension (mm) Abmessung (mm)				Kesici Uç Insert Wendeschneidplatte	Baskı Pabuçu Wedge Clamp Spannpratze	Pabuç Vidası Clamp Screw Klemmschraube	Altık Shim Unterlege	Pim Pin Stift	Pul Shim Ring	Anahtar Allenkey Innensechskantschlüssel
	HF H	B	LF	WF							
MTJNR/L 2020 K16	20	20	125	25	TNM.1604	HBP-08	HPV-02- M6x22	HTNM-16	HPM-01	HP-01	HAL-03
2525 M16	25	25	150	32							
3232 P16	32	32	170	40							
2525 M22	25	25	150	32	TNM.2204			HTNM-22	HPM-02		
3232 P22	32	32	170	40							
4040 S22	40	40	250	50							

MWLNR

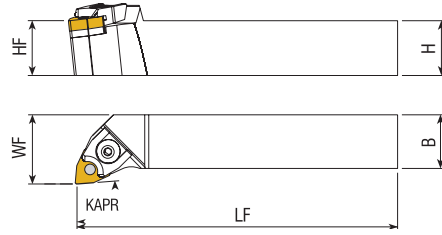
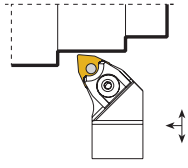

KAPR=95°



Takım Kodu Ordering Code Bestell-Bezeichnung	Takım Ölçüleri (mm) Dimension (mm) Abmessung (mm)				Kesici Uç Insert Wendeschneidplatte	Baskı Pabuçu Wedge Clamp Spannpratze	Pabuç Vidası Clamp Screw Klemmschraube	Altık Shim Unterlege	Pim Pin Stift	Pul Shim Ring	Anahtar Allenkey Innensechskantschlüssel
	HF H	B	LF	WF							
MWLNR/L 1616 H06	16	16	100	20	WNM.0604	HBP-05	HPV-04-M5*15	HWNM-06	HPM-03	HP-01	HAL-03
2020 K06	20	20	125	25							
2525 M06	25	25	150	32							
2020 K08	20	20	125	25	WNM.0804	HBP-06	HPV-02-M6*22	HWNM-08	HPM-02	HP-01	HAL-03
2525 M08	25	25	150	32							
3232 P08	32	32	170	40							

MWMNN

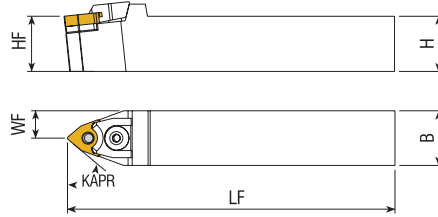
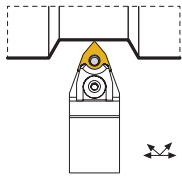

KAPR=50°







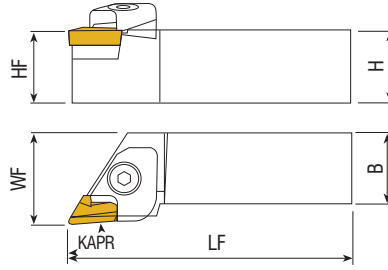
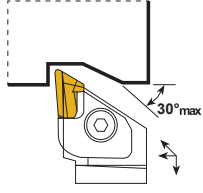



Takım Kodu Ordering Code Bestell-Bezeichnung	Takım Ölçüleri (mm) Dimension (mm) Abmessung (mm)				Kesici Uç Insert Wendeschneidplatte	Baskı Pabuçu Wedge Clamp Spannpratze	Pabuç Vidası Clamp Screw Klemmschraube	Altık Shim Unterlege	Pim Pin Stift	Pul Shim Ring	Anahtar Allenkey Innensechskantschlüssel
	HF H	B	LF	WF							
MWMNN 1616 H06	16	16	100	8	WNM.0604	HBP-05	HPV-04-M5*15	HWNM-06	HPM-03	HP-01	HAL-03
2020 K06	20	20	125	10							
2525 M06	25	25	150	12,5							
2020 K08	20	20	125	10	WNM.0804	HBP-06	HPV-02-M6*22	HWNM-08	HPM-02	HP-01	HAL-03
2525 M08	25	25	150	12,5							
3232 P08	32	32	170	16							

CKJNR



KAPR=93°

 Takım Kodu Ordering Code Bestell-Bezeichnung	Takım Ölçüleri (mm) Dimension (mm) Abmessung (mm)				Kesici Uç Insert Wendeschneidplatte	Baskı Pabucu Wedge Clamp Spannpratze	Pabuç Vidası Clamp Screw Klemmschraube	Altık Shim Unterlage	Altık Vidası Shim Screw Schraube für Unterlage	Pul Shim Ring	Anahtar Allenkey Innensechskantschlüssel
	HF H	B	LF	WF							
CKJNR/L 2020 K16	20	20	125	275	KNUX 1604	HBP-09-R HBP-09-L	HPV- 05-M6*22	HKNR-16 HKNL-16	HAV- 01-M3*10	HP-01	HAL-04
2525 M16	25	25	150	315							
3232 P16	32	32	170	40							
4040 S16	40	40	250	50							

Perfect Cut



SCACR

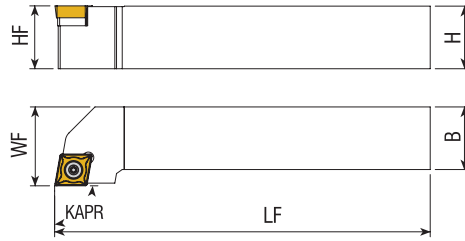
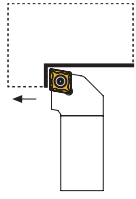

KAPR=90°

Takım Kodu Ordering Code Bestell-Bezeichnung	Takım Ölçüleri (mm) Dimension (mm) Abmessung (mm)				Kesici Uç Insert Wendeschneidplatte	Sıkma Vidası Screw Schraube	Altık Shim Unterlage	Altık Vidası Shim Screw Schraube für Unterlage	Tork Anahtar Torx Key Torx-Schlüssel			
	HF H	B	LF	WF								
SCACR/L 0808 E06	8	8	70	10	CC.T 0602	1060-M2.5x6	-	-	HTA-T08			
1010 E06	10	10	70	12								
1212 F09	12	12	80	16	CC.T 09T3	1060-M3.5x11	HCCM-09	HBV-02-M3.5x11	HTA-T15			
1616 H09	16	16	100	20		1060-M3.5x14						
2020 K09	20	20	125	25		CC.T 1204				1060-M4.5x16	HCCM-12	HBV-04-M4.5x13
2020 K12	20	20	125	25								
2525 M12	25	25	150	32								

SCLCR

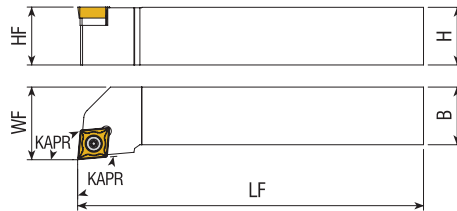
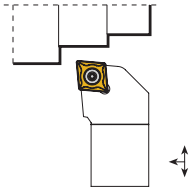

KAPR=95°

Takım Kodu Ordering Code Bestell-Bezeichnung	Takım Ölçüleri (mm) Dimension (mm) Abmessung (mm)				Kesici Uç Insert Wendeschneidplatte	Sıkma Vidası Screw Schraube	Altık Shim Unterlage	Altık Vidası Shim Screw Schraube für Unterlage	Tork Anahtar Torx Key Torx-Schlüssel			
	HF H	B	LF	WF								
SCLCR/L 0808 E06	8	8	70	10	CC.T 0602	1060-M2.5x6	-	-	HTA-T08			
1010 E06	10	10	70	12								
1212 F06	12	12	80	16	CC.T 09T3	1060-M3.5x9	HCCM-09	HBV-02-M3.5x11	HTA-T15			
1010 E09	10	10	70	12		1060-M3.5x12						
1212 F09	12	12	80	16		CC.T 1204				1060-M5x11	HCCM-12	HBV-04-M4.5x13
1616 H09	16	16	100	20								
2020 K09	20	20	125	25	CC.T 1204	1060-M4.5x16	HCCM-12	HBV-04-M4.5x13	HTA-T20			
2525 M09	25	25	150	32								
1616 H12	16	16	100	20								
2020 K12	20	20	125	25								
2525 M12	25	25	150	32								

Açıklama | Explanation | Erläuterung

R: Sağ / Right / Rechts L: Sol / Left / Links







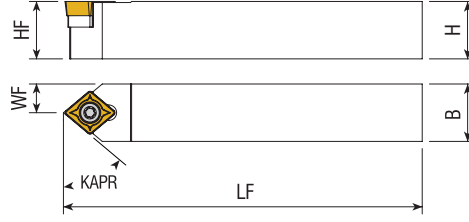
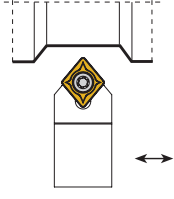

Sipariş Örneği / Ordering Example / Bestellbeispiel
1 ad./pcs./stück SVJBR 2525 M16

SCMCN







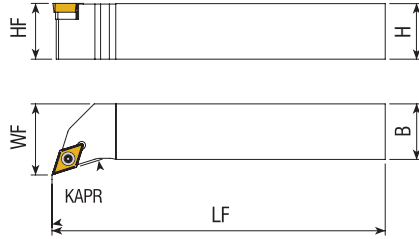
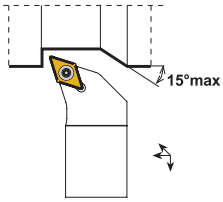

KAPR=50°

 Takım Kodu Ordering Code Bestell-Bezeichnung	Takım Ölçüleri (mm) Dimension (mm) Abmessung (mm)				Kesici Uç Insert Wendeschneidplatte	Sıkma Vidası Screw Schraube	Altlık Shim Unterlage	Altlık Vidası Shim Screw Schraube für Unterlage	Tork Anahtar Torx Key Torx-Schlüssel
	HF H	B	LF	WF					
SCMCN 0808 E06	8	8	70	4		1060-M2.5x6	-	-	HTA-T08
1010 E06	10	10	70	5	CC.T 0602	1060-M2.5x6	-	-	HTA-T08
1212 F06	12	12	80	6	CC.T 0602	1060-M3.5x12	-	-	HTA-T15
1212 F09	12	12	80	6	CC.T 09T3	1060-M3.5x12	-	-	HTA-T15
1616 H09	16	16	100	8	CC.T 09T3	1060-M3.5x14	HCCM-09	HBV-02-M3.5x11	HTA-T15
2020 K12	20	20	125	10	CC.T 1204	1060-M4.5x16	HCCM-12	HBV-04-M4.5x13	HTA-T20
2525 M12	25	25	150	12.5	CC.T 1204	1060-M4.5x16	HCCM-12	HBV-04-M4.5x13	HTA-T20

SDHCR







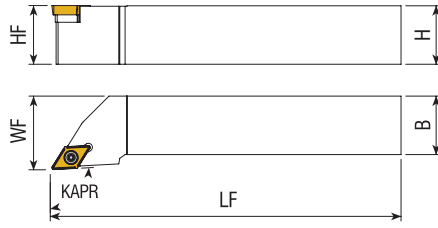
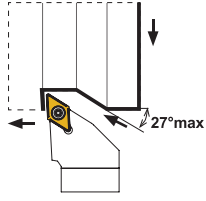

KAPR=107,5°

 Takım Kodu Ordering Code Bestell-Bezeichnung	Takım Ölçüleri (mm) Dimension (mm) Abmessung (mm)				Kesici Uç Insert Wendeschneidplatte	Sıkma Vidası Screw Schraube	Altlık Shim Unterlage	Altlık Vidası Shim Screw Schraube für Unterlage	Tork Anahtar Torx Key Torx-Schlüssel
	HF H	B	LF	WF					
SDHCR/L 0808 E07	8	8	70	11		1060-M2.5x6	-	-	HTA-T08
1010 E07	10	10	70	12	DC.T 0702	1060-M2.5x6	-	-	HTA-T08
1212 F07	12	12	80	16	DC.T 0702	1060-M3.5x12	-	-	HTA-T15
1616 H07	16	16	100	20	DC.T 0702	1060-M3.5x14	HDCM-09	HBV-02-M3.5x11	HTA-T15
1616 H11	16	16	100	20	DC.T 11T3	1060-M3.5x14	HDCM-11	HBV-02-M3.5x11	HTA-T15
2020 K11	20	20	125	25	DC.T 11T3	1060-M4.5x16	HDCM-11	HBV-04-M4.5x13	HTA-T20
2525 M11	25	25	150	32	DC.T 11T3	1060-M4.5x16	HDCM-11	HBV-04-M4.5x13	HTA-T20
3232 P11	32	32	170	40	DC.T 11T3	1060-M4.5x16	HDCM-11	HBV-04-M4.5x13	HTA-T20

SDJCR







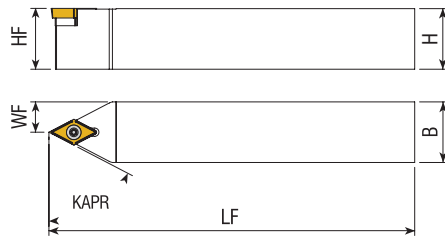
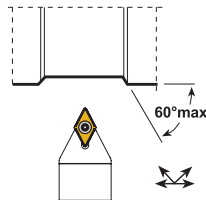

KAPR=93°

 Takım Kodu Ordering Code Bestell-Bezeichnung	Takım Ölçüleri (mm) Dimension (mm) Abmessung (mm)				Kesici Uç Insert Wendeschneidplatte	Sıkma Vidası Screw Schraube	Altık Shim Unterlage	Altık Vidası Shim Screw Schraube für Unterlage	Tork Anahtar Torx Key Torx-Schlüssel
	HF H	B	LF	WF					
SDJCR/L 0808 E07	8	8	70	10	DC.T 0702	1060-M2.5x6	-	-	HTA-T08
1010 E07	10	10	70	12					
1212 F07	12	12	80	16					
1616 H07	16	16	100	20					
1616 H11	16	16	100	20	DC.T 11T3	1060-M3.5x14	HDCM-11	HBV-02-M3.5x11	HTA-T15
2020 K11	20	20	125	25					
2525 M11	25	25	150	32					
3232 P11	32	32	170	40					

SDNCN







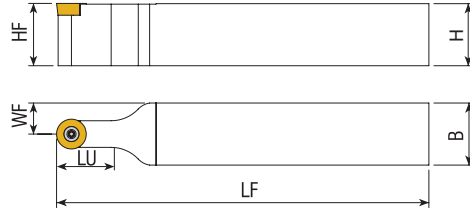
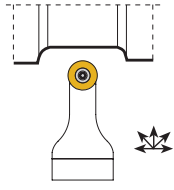

KAPR=62,5°

 Takım Kodu Ordering Code Bestell-Bezeichnung	Takım Ölçüleri (mm) Dimension (mm) Abmessung (mm)				Kesici Uç Insert Wendeschneidplatte	Sıkma Vidası Screw Schraube	Altık Shim Unterlage	Altık Vidası Shim Screw Schraube für Unterlage	Tork Anahtar Torx Key Torx-Schlüssel
	HF H	B	LF	WF					
SDNCN/0808 E07	8	8	70	4	DC.T 0702	1060-M2.5x6	-	-	HTA-T08
1010 E07	10	10	70	5					
1212 F07	12	12	80	6					
1616 H07	16	16	100	8					
1616 H11	16	16	100	8	DC.T 11T3	1060-M3.5x14	HDCM-11	HBV-02-M3.5x11	HTA-T15
2020 K11	20	20	125	10					
2525 M11	25	25	150	12.5					
3232 P11	32	32	170	16					

SRDCN



 Takım Kodu Ordering Code Bestell-Bezeichnung	Takım Ölçüleri (mm) Dimension (mm) Abmessung (mm)					Kesici Uç Insert Wendschnei-platte	Sıkma Vidası Screw Schraube	Altık Shim Unterlage	Altık Vidası Shim Screw Schraube für Unterlage	Tork Anahtar Torx Key Torx-Schlüssel
	HF H	B	LF	LU	WF					
SRDCN 1616 H06	16	16	100	15	8					
2020 K06	20	20	125	17	10	RCT 0602	1060-M2.5x6			HTA-T08
2525 M06	25	25	150	17	12.5					
1616 H08	16	16	100	15	8					
2020 K08	20	20	125	20	10	RCT 0803	1060-M3x8			HTA-T15
2525 M08	25	25	150	20	12.5					
1616 H10	16	16	100	20	8					
2020 K10	20	20	125	20	10	RCT 10T3		-	-	HTA-T20
2525 M10	25	25	150	20	12.5		1060-M3.5x12			
3232 P10	32	32	170	20	16					
2020 K12	20	20	125	22	10	RCT 1204				HTA-T20
2525 M12	25	25	150	22	12.5					
3232 P12	32	32	170	22	16					
2525 M16	25	25	150	32	12.5	RCT 1605	1060-M5x11			HTA-T20
3232 P16	32	32	170	35	16					
2525 M20	25	25	150	32	12.5	RCT 2006	1060-M6x16			
3232 P20	32	32	170	40	16					

SRDCR

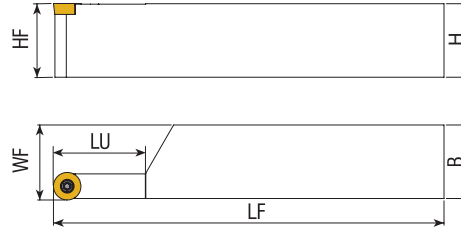
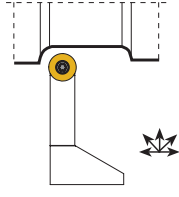

Takım Kodu Ordering Code Bestell-Bezeichnung	Takım Ölçüleri (mm) Dimension (mm) Abmessung (mm)					Kesici Uç Insert Wendeschneidplatte	Sıkma Vidası Screw Schraube	Altık Shim Unterlage	Altık Vidası Shim Screw Schraube für Unterlage	Tork Anahtar Torx Key Torx-Schlüssel
	HF H	B	LF	LU	WF					
SRDCR/L 3232 T06	32	32	300	20	32.35	RC.T 0602	1060-M2.5x6			HTA-T08
3232 P12	32	32	170	40	32.65	RC.T 1204	1060-M3.5x11	-	-	HTA-T15



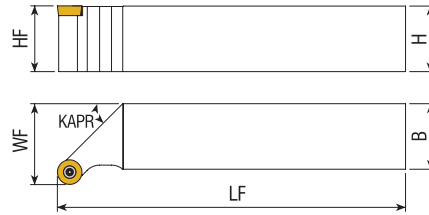
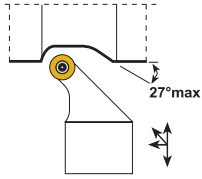



SRGCR

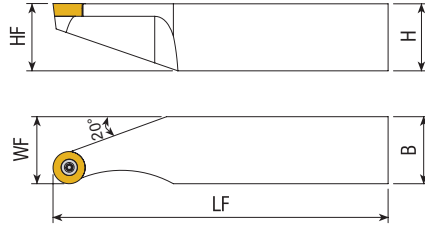
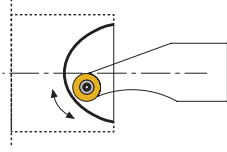

Takım Kodu Ordering Code Bestell-Bezeichnung	Takım Ölçüleri (mm) Dimension (mm) Abmessung (mm)				Kesici Uç Insert Wendeschneidplatte	Sıkma Vidası Screw Schraube	Altık Shim Unterlage	Altık Vidası Shim Screw Schraube für Unterlage	Tork Anahtar Torx Key Torx-Schlüssel
	HF H	B	LF	WF					
SRGCR/L 1616 H06	16	16	100	20	RC.T 0602	1060-M2.5x6			HTA-T08
2020 K06	20	20	125	25					
1616 H08	16	16	100	20	RC.T 0803	1060-M3x8			
2020 K08	20	20	125	25					
2525 M08	25	25	150	32	RC.T 10T3	1060-M3.5x12			HTA-T15
1616 H10	16	16	100	20					
2020 K10	20	20	125	25					
2525 M10	25	25	150	32					
3232 P10	32	32	170	40	RC.T 1204				
2020 K12	20	20	125	25					
2525 M12	25	25	150	32					
3232 P12	32	32	170	40					







SRHCR

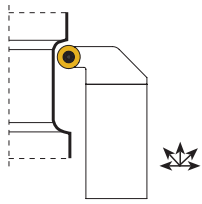

 Takım Kodu Ordering Code Bestell-Bezeichnung	Takım Ölçüleri (mm) Dimension (mm) Abmessung (mm)					Kesici Uç Insert Wendschnei-platte	Sıkma Vidası Screw Schraube	Altık Shim Unterlage	Altık Vidası Shim Screw Schraube für Unterlage	Tork Anahtar Torx Key Torx-Schlüssel
	$\frac{HF}{H}$	B	LF	WF	MIN R					
SRHCR/L 2525 K06	25	25	125	25	32.5	RC.T 0602	1060-M2.5x6			HTA-T08
2525 K08	25	25	125	25	32.5	RC.T 0803	1060-M3x8			HTA-T15
2525 K10	25	25	125	25	36	RC.T 10T3		-	-	HTA-T15
2525 K12	25	25	125	25	40	RC.T 1204	1060-M5x11			HTA-T20
2525 K16	25	25	125	25	47.5	RC.T 1606				HTA-T20

SRXCR



 Takım Kodu Ordering Code Bestell-Bezeichnung	Takım Ölçüleri (mm) Dimension (mm) Abmessung (mm)				Kesici Uç Insert Wendschnei-platte	Sıkma Vidası Screw Schraube	Altık Shim Unterlage	Altık Vidası Shim Screw Schraube für Unterlage	Tork Anahtar Torx Key Torx-Schlüssel
	$\frac{HF}{H}$	B	LF	WF					
SRXCR/L 2525 M08	25	25	150	40	RC.T 0602	1060-M3x8			HTA-T08
2525 M10	25	25	150	40	RC.T 10T3	1060-M3.5x12			HTA-T15
2525 M12	25	25	150	40	RC.T 1204		-	-	HTA-T15
3232 P08	32	32	220	47	RC.T 0803	1060-M3x8			HTA-T08
3232 P10	32	32	220	47	RC.T 10T3	1060-M3.5x12			HTA-T15
3232 P12	32	32	220	47	RC.T 1204				HTA-T15

SSDCN

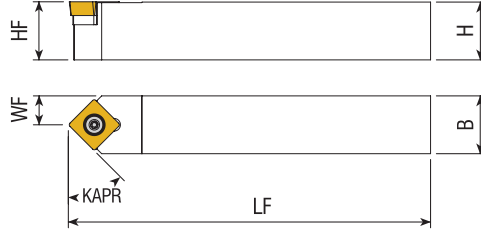
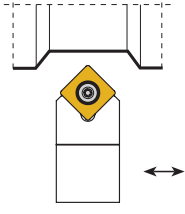

KAPR=45°

Takım Kodu Ordering Code Bestell-Bezeichnung	Takım Ölçüleri (mm) Dimension (mm) Abmessung (mm)				Kesici Uç Insert Wendeschneidplatte	Sıkma Vidası Screw Schraube	Altık Shim Unterlage	Altık Vidası Shim Screw Schraube für Unterlage	Tork Anahtar Torx Key Torx-Schlüssel
	HF H	B	LF	WF					
SSDCN 1212 F09	12	12	80	6		1060-M3.5x12	-	-	
1616 H09	16	16	100	8	SC.T 09T3	1060-M3.5x14	HSCM-09	HBV-02-M3.5x11	HTA-T15
2020 K09	20	20	125	10		1060-M4.5x12		HBV-03-M4.5x8	
1616 H12	16	16	100	8	SC.T 1204	1060-M4.5x16	HSCM-12	HBV-04-M4.5x13	HTA-T20
2020 K12	20	20	125	10					
2525 M12	25	25	150	12.5					

SSSCR

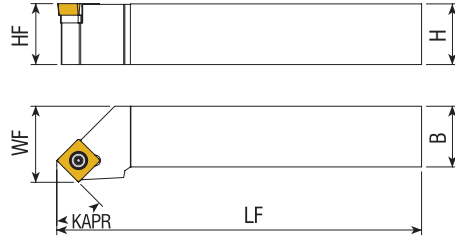
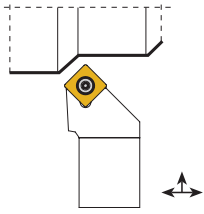

KAPR=45°

Takım Kodu Ordering Code Bestell-Bezeichnung	Takım Ölçüleri (mm) Dimension (mm) Abmessung (mm)				Kesici Uç Insert Wendeschneidplatte	Sıkma Vidası Screw Schraube	Altık Shim Unterlage	Altık Vidası Shim Screw Schraube für Unterlage	Tork Anahtar Torx Key Torx-Schlüssel
	HF H	B	LF	WF					
SSSCR/L 1212 F09	12	12	80	16		1060-M3.5x12	-	-	
1616 H09	16	16	100	20	SC.T 09T3	1060-M3.5x14	HSCM-09	HBV-02-M3.5x11	HTA-T15
2020 K09	20	20	125	25		1060-M4.5x12		HBV-03-M4.5x8	
1616 H12	16	16	100	20	SC.T 1204	1060-M4.5x16	HSCM-12	HBV-04-M4.5x13	HTA-T20
2020 K12	20	20	125	25					
2525 M12	25	25	150	32					

STFCR

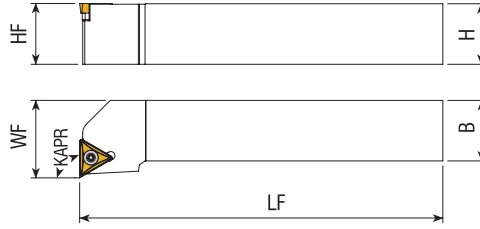
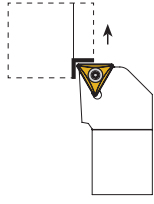

KAPR=90°

Takım Kodu Ordering Code Bestell-Bezeichnung	Takım Ölçüleri (mm) Dimension (mm) Abmessung (mm)				Kesici Uç Insert Wendeschneidplatte	Sıkma Vidası Screw Schraube	Altık Shim Unterlage	Altık Vidası Shim Screw Schraube für Unterlage	Tork Anahtar Torx Key Torx-Schlüssel
	HF H	B	LF	WF					
STFCR/L 0808 E09	8	8	70	10	TC:T 0902	1060-M2.2x5			HTA-T07
1010 E09	10	10	70	12					
1212 F11	12	12	80	16	TC:T 1102	1060-M2.5x6			HTA-T08
1616 H11	16	16	100	20					
1616 H16	16	16	100	20	TC:T 16T3	1060-M3.5x14			HTA-T15
2020 K16	20	20	125	25					
2525 M16	25	25	150	32					
3232 P16	32	32	170	40					

STGCR

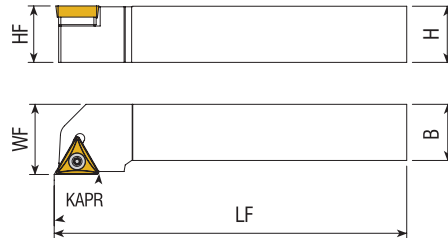
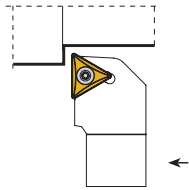

KAPR=90°

Takım Kodu Ordering Code Bestell-Bezeichnung	Takım Ölçüleri (mm) Dimension (mm) Abmessung (mm)				Kesici Uç Insert Wendeschneidplatte	Sıkma Vidası Screw Schraube	Altık Shim Unterlage	Altık Vidası Shim Screw Schraube für Unterlage	Tork Anahtar Torx Key Torx-Schlüssel
	HF H	B	LF	WF					
STGCR/L 0808 E09	8	8	70	10	TC:T 0902	1060-M2.2x5			HTA-T07
1010 E09	10	10	70	12					
1212 F11	12	12	80	16	TC:T 1102	1060-M2.5x6			HTA-T08
1616 H11	16	16	100	20					
1616 H16	16	16	100	20	TC:T 16T3	1060-M3.5x14			HTA-T15
2020 K16	20	20	125	25					
2525 M16	25	25	150	32					
3232 P16	32	32	170	40					

STJCR

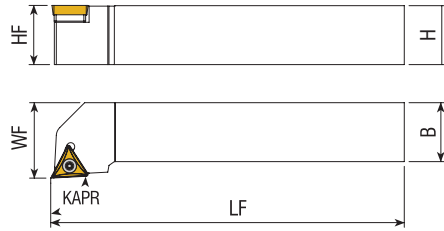
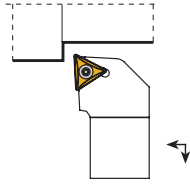

KAPR=93°

Takım Kodu Ordering Code Bestell-Bezeichnung	Takım Ölçüleri (mm) Dimension (mm) Abmessung (mm)				Kesici Uç Insert Wendeschneidplatte	Sıkma Vidası Screw Schraube	Altlık Shim Unterlage	Altlık Vidası Shim Screw Schraube für Unterlage	Tork Anahtar Torx Key Torx-Schlüssel
	HF H	B	LF	WF					
STJCR/L 0808 E09	8	8	70	10	TC.T 0902	1060-M2.2x5			HTA-T07
1010 E09	10	10	70	12					
1212 F11	12	12	80	16	TC.T 1102	1060-M2.5x6			HTA-T08
1616 H11	16	16	100	20					
1616 H16	16	16	100	20	TC.T 16T3	1060-M3.5x14			HTA-T15
2020 K16	20	20	125	25					
2525 M16	25	25	150	32					
3232 P16	32	32	170	40					

STCCN

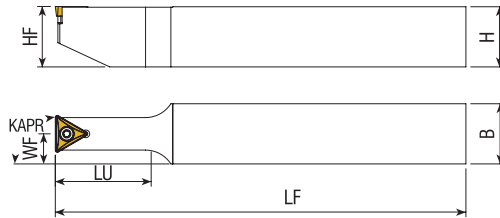
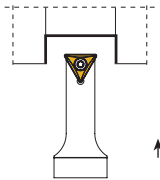

KAPR=90°

Takım Kodu Ordering Code Bestell-Bezeichnung	Takım Ölçüleri (mm) Dimension (mm) Abmessung (mm)					Kesici Uç Insert Wendeschneidplatte	Sıkma Vidası Screw Schraube	Altlık Shim Unterlage	Altlık Vidası Shim Screw Schraube für Unterlage	Tork Anahtar Torx Key Torx-Schlüssel
	HF H	B	LF	LU	WF					
1616 K16	16	16	125	24	8	TC.T 16T3	1060-M3.5x14			HTA-T15
2020 M16	20	20	150	30	10					
2525 M16	25	25	150	37.5	12.5					
3232 P16	32	32	170	48	16					
2525 P22	25	25	170	80	12.5	TC.T 2204	1060-M4.5x12			HTA-T20

STUCR

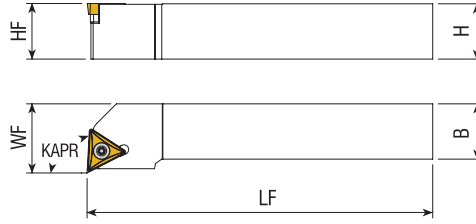
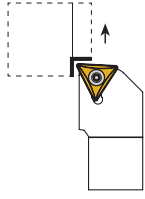

KAPR=93°

Takım Kodu Ordering Code Bestell-Bezeichnung	Takım Ölçüleri (mm) Dimension (mm) Abmessung (mm)				Kesici Uç Insert Wendeschneidplatte	Sıkma Vidası Screw Schraube	Altık Shim Unterlage	Altık Vidası Shim Screw Schraube für Unterlage	Tork Anahtar Torx Key Torx-Schlüssel
	HF H	B	LF	WF					
STUCR/L 0808 E09	8	8	70	10	TC:T 0902	1060-M2.2x5			HTA-T07
1010 E09	10	10	70	12					
1212 F11	12	12	80	16	TC:T 1102	1060-M2.5x6			HTA-T08
1616 H11	16	16	100	20					
1616 H16	16	16	100	20	TC:T 16T3	1060-M3.5x14			HTA-T15
2020 K16	20	20	125	25					
2525 M16	25	25	150	32					
3232 P16	32	32	170	40					

SVHBR

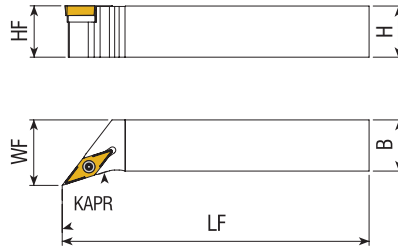
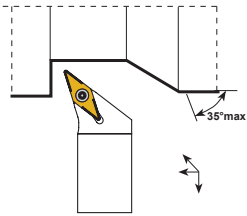

KAPR=107,5°

Takım Kodu Ordering Code Bestell-Bezeichnung	Takım Ölçüleri (mm) Dimension (mm) Abmessung (mm)				Kesici Uç Insert Wendeschneidplatte	Sıkma Vidası Screw Schraube	Altık Shim Unterlage	Altık Vidası Shim Screw Schraube für Unterlage	Tork Anahtar Torx Key Torx-Schlüssel
	HF H	B	LF	WF					
SVHBR/L 1212 F11	12	12	80	16	VBT 1103	1060-M2.5x6			HTA-T08
1616 H11	16	16	100	20					
2020 K11	20	20	125	25	VBT 1604	1060-M3.5x14	HVBM-16	HBV-02-M3.5x11	HTA-T15
2020 K16	20	20	125	25					
2525 M16	25	25	150	32					
3232 P16	32	32	170	40					

SVHCR

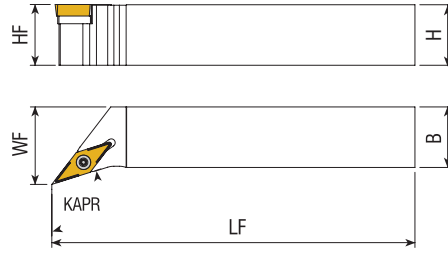
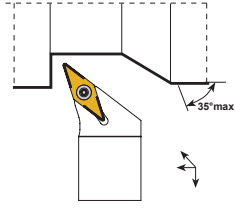

KAPR=107,5°



Takım Kodu Ordering Code Bestell-Bezeichnung	Takım Ölçüleri (mm) Dimension (mm) Abmessung (mm)				Kesici Uç Insert Wendeschneidplatte	Sıkma Vidası Screw Schraube	Altlık Shim Unterlage	Altlık Vidası Shim Screw Schraube für Unterlage	Tork Anahtar Torx Key Torx-Schlüssel
	HF H	B	LF	WF					
SVHCR/L 1212 F11	12	12	80	16					
1616 H11	16	16	100	20	VC.T1103	1060-M2.5x6	-	-	HTA-T08
2020 K11	20	20	125	25					
2020 K16	20	20	125	25					
2525 M16	25	25	150	32	VC.T1604	1060-M3.5x14	HVBM-16	HBV-02-M3.5x11	HTA-T15
3232 P16	32	32	170	40					

SVJBR

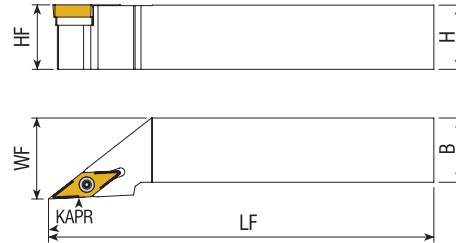
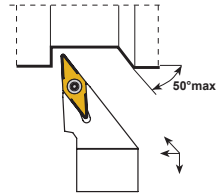

KAPR=93°

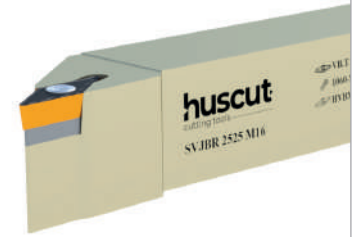

Takım Kodu Ordering Code Bestell-Bezeichnung	Takım Ölçüleri (mm) Dimension (mm) Abmessung (mm)				Kesici Uç Insert Wendeschneidplatte	Sıkma Vidası Screw Schraube	Altlık Shim Unterlage	Altlık Vidası Shim Screw Schraube für Unterlage	Tork Anahtar Torx Key Torx-Schlüssel
	HF H	B	LF	WF					
SVJBR/L 1212 F11	12	12	80	16					
1616 H11	16	16	100	20	VBT1103	1060-M2.5x6	-	-	HTA-T08
2020 K11	20	20	125	25					
1616 H16	16	16	100	20					
2020 K16	20	20	125	25	VBT1604	1060-M3.5x14	HVBM-16	HBV-02-M3.5x11	HTA-T15
2525 M16	25	25	150	32					
3232 P16	32	32	170	40					

SVJCR

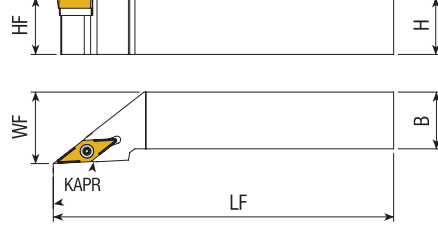
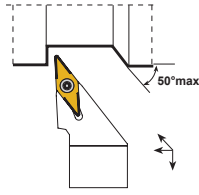

KAPR=93°

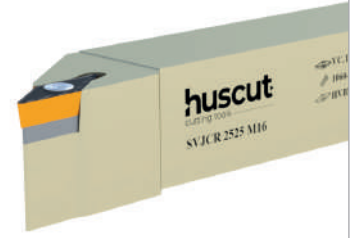

Takım Kodu Ordering Code Bestell-Bezeichnung	Takım Ölçüleri (mm) Dimension (mm) Abmessung (mm)				Kesici Uç Insert Wendeschneidplatte	Sıkma Vidası Screw Schraube	Altık Shim Unterlage	Altık Vidası Shim Screw Schraube für Unterlage	Tork Anahtar Torx Key Torx-Schlüssel
	HF H	B	LF	WF					
SVJCR/L 1212 F11	12	12	80	16	VCT1103	1060-M2.5x6	-	-	HTA-T08
1616 H11	16	16	100	20					
2020 K11	20	20	125	25					
2525 M11	25	25	150	32					
2020 K16	20	20	125	25	VCT1604	1060-M3.5x14	HVBM-16	HBV-02-M3.5x11	HTA-T15
2525 M16	25	25	150	32					
3232 P16	32	32	170	40					

SVVBN

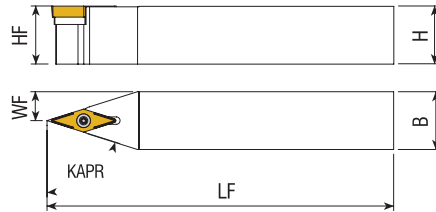
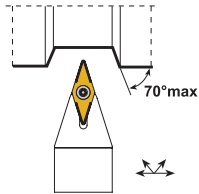

KAPR=72,5°





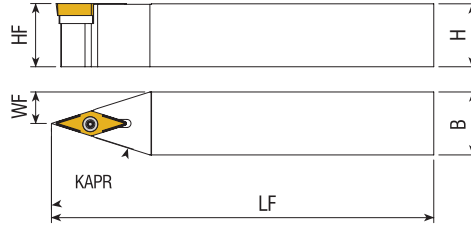
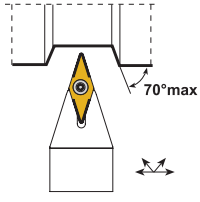

Takım Kodu Ordering Code Bestell-Bezeichnung	Takım Ölçüleri (mm) Dimension (mm) Abmessung (mm)				Kesici Uç Insert Wendeschneidplatte	Sıkma Vidası Screw Schraube	Altık Shim Unterlage	Altık Vidası Shim Screw Schraube für Unterlage	Tork Anahtar Torx Key Torx-Schlüssel
	HF H	B	LF	WF					
SVVBN 1212 F11	12	12	80	6	VBT1103	1060-M2.5x6	-	-	HTA-T08
1616 H11	16	16	100	8					
2020 K11	20	20	125	10					
2020 K16	20	20	125	10					
2525 M16	25	25	150	12.5	VBT1604	1060-M3.5x14	HVBM-16	HBV-02-M3.5x11	HTA-T15
3232 P16	32	32	170	16					

SVVCN

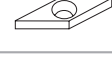

KAPR=72,5°

 Takım Kodu Ordering Code Bestell-Bezeichnung	Takım Ölçüleri (mm) Dimension (mm) Abmessung (mm)				Kesici Uç Insert Wendschneidplatte	Sıkma Vidası Screw Schraube	Altık Shim Unterlage	Altık Vidası Shim Screw Schraube für Unterlage	Tork Anahtar Torx Key Torx-Schlüssel
	HF H	B	LF	WF					
SVVCN/1212 F11	12	12	12	6					
1616 H11	16	16	16	8	VCT1103	1060-M2.5x6	-	-	HTA-T08
2020 K11	20	20	20	10					
2020 K16	20	20	20	10					
2525 M16	25	25	25	12.5	VCT1604	1060-M3.5x14	HVBM-16	HBV-02-M3.5x11	HTA-T15
3232 P16	32	32	32	16					

Perfect
Cut













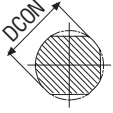
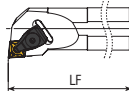
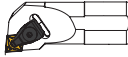



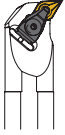
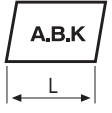
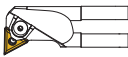



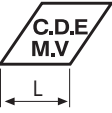
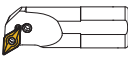



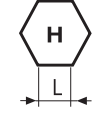



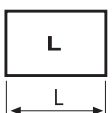
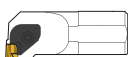



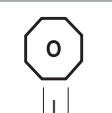



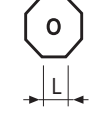



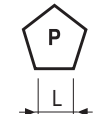



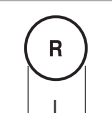



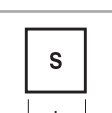

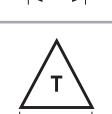

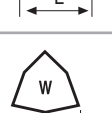

Delik Torna Takımları

Boring Bars

Bohrstange







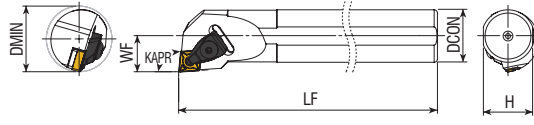
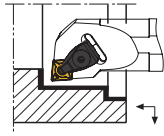







S	25	S	T	D	U	N	R	15
1	2	3	4	5	6	7	8	9
Takım Malzemesi Tool Material Werkzeugmaterial	Şaft Çapı Shank Diameter Schaft Durchmesser	Şaft Boyu Shank Length Schaftlänge	Bağlama Tipi Clamping Type Klemmsystem	Uç Tipi Type Of Insert Plattenform	Yanaşma Açısı Berthing Angle Anlegewinkel	Serbest Uç Açısı Free End Angle Freiwinkel	Kesme Yönü Cutting Direction Schnittrichtung	Kenar Uzunluğu Edge Length Schneidkantenlänge
Yekpare çelik gövde soğutma suyu kanallı Solid steel body with cooling water channel A			 Cektirmeli With Puller Mit Puller T	 C	 L	 A	 L	 A.B.K
Massiver Stahlkörper mit Kühlwasserkanal A		A-32 B-40 C-50 D-60 E-70 F-80 G-90 H-100 J-110 K-125 L-140 M-150 N-160 P-170 Q-180 R-200 S-250 T-300 U-350 V-400 W-450 X-Special	 Baska Papuçlu With Puller Mit Puller M	 D	 F	 B	 L	 C.D.E M.V
Çelik başlıkla sert metal gövde ve soğutma suyu kanallı Hard metal body and coolant channels with steel cap E			 Levyeli Lever Hebel P	 E	 S	 C	 R	 H
Hartmetallkörper und Kühlmittelkanäle mit Stahlkappe E			 Vidalı Screwed Aufgeschmissen S	 K	 X	 D		 L
Karbür Şaft Carbide shank C			 Cektirmeli With Puller Mit Puller C	 L	 J	 E		 L
Hartmetallwelle C				 R	 U	 F		 O
Çelik Şaft Steel shank S				 S	 K	 G		 P
Stahlwelle S				 T	 Q	 N		 R
				 V	 P	 P		 S
				 W	 A			 T
				 A	 B			 W
				 B	 H			
				 H	 M			
				 M	 O			
				 O	 P			
				 P				

TCLNR







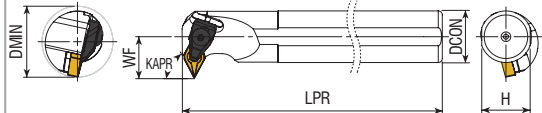
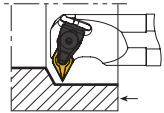

KAPR=95°

 Takım Kodu Ordering Code Bestell- Bezeichnung	Takım Ölçüleri (mm) Dimension (mm) Abmessung (mm)					Kesici Uç Insert Wendeschnei- Platte	Baskı Pabucu Wedge Clamp Spannpratze	Pabuç Vidası Clamp Screw Klemmschraube	Altık Shim Unterlage	Altık Vidası Shim Screw Schraube für Unterlage	Pul Shim Shim Ring	Anahtar Allenkey Innensech- skantschlüssel
	DCON	H	LF	WF	DMIN							
S25S TCLNR/L 12	25	23	250	17	≥32	 CNM.1204	 HBP-02	 HPV-02- M6x22	 HCNM-12	HAV-04-M5*8	 HP-01	 HAL-03
S32T TCLNR/L 12	32	30	300	22	≥40							
S40U TCLNR/L 12	40	37.5	350	27	≥50							
S50V TCLNR/L 12	50	47	400	35	≥63	 CNM.1606	 HBP-04	 HPV-03- M7x25	 HCNM-16	HAV-02-M5*12	 HP-02	 HAL-04
S32T TCLNR/L 16	32	30	300	22	≥40							
S40U TCLNR/L 16	40	37.5	350	27	≥50							
S50V TCLNR/L 16	50	47	400	35	≥63							

TD-NR



KAPR=62,5°

 Takım Kodu Ordering Code Bestell- Bezeichnung	Takım Ölçüleri (mm) Dimension (mm) Abmessung (mm)					Kesici Uç Insert Wendeschnei- Platte	Baskı Pabucu Wedge Clamp Spannpratze	Pabuç Vidası Clamp Screw Klemmschraube	Altık Shim Unterlage	Altık Vidası Shim Screw Schraube für Unterlage	Pul Shim Shim Ring	Anahtar Allenkey Innensech- skantschlüssel
	DCON	H	LF	WF	DMIN							
S32T TD-NR/L 15	32	30	300	26	≥44	 DNM.1506	 HBP-02	 HPV-02-M6*22	 HDNM-15	HAV-02-M5*12	 HP-01	 HAL-03
S40U TD-NR/L 15	40	37.5	350	29	≥52							
S50V TD-NR/L 15	50	47	400	35	≥63							

TDQNR

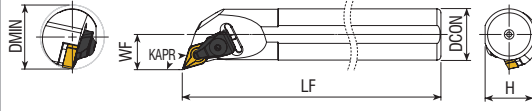
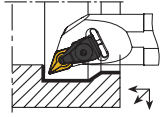

KAPR=107,5°

 Takım Kodu Ordering Code Bestell- Bezeichnung	Takım Ölçüleri (mm) Dimension (mm) Abmessung (mm)					Kesici Uç Insert Wendeschnei Platte	Baskı Pabucu Wedge Clamp Spannpratze	Pabuç Vidası Clamp Screw Klemmschraube	Altık Shim Unterlage	Altık Vidası Shim Screw Schraube für Unterlage	Pul Shim Ring	Anahtar Allenkey Innensech- skantschlüssel
	DCON	H	LF	WF	DMIN							
S25S TDQNR/L 11	25	23	250	17	≥32	DNM.1104	HBP-01	HPV-01-M5*22	HDCM-11	HAV-03-M5*8	HP-01	HAL-03
S32T TDQNR/L 11	32	30	300	22	≥40					HAV-04-M5*8		
S25S TDQNR/L 15	25	23	250	17	≥32	DNM.1506	HBP-02	HPV-02-M6*22	HDNM-15	HAV-02-M5*12		
S32T TDQNR/L 15	32	30	300	22	≥40							
S40U TDQNR/L 15	40	37.5	350	27	≥50							
S50V TDQNR/L 15	50	47	400	35	≥63							

TDUNR

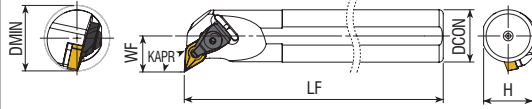
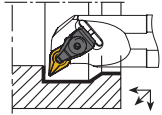







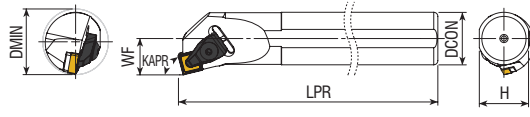
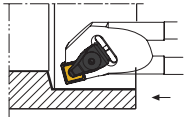

KAPR=93°

 Takım Kodu Ordering Code Bestell- Bezeichnung	Takım Ölçüleri (mm) Dimension (mm) Abmessung (mm)					Kesici Uç Insert Wendeschnei Platte	Baskı Pabucu Wedge Clamp Spannpratze	Pabuç Vidası Clamp Screw Klemmschraube	Altık Shim Unterlage	Altık Vidası Shim Screw Schraube für Unterlage	Pul Shim Ring	Anahtar Allenkey Innensech- skantschlüssel
	DCON	H	LF	WF	DMIN							
S25S TDUNR/L 11	25	23	250	17	≥32	DNM.1104	HBP-01	HPV-01-M5*22	HDCM-11	HAV-03-M5*8	HP-01	HAL-03
S32T TDUNR/L 11	32	30	300	22	≥40					HAV-04-M5*8		
S25S TDUNR/L 15	25	23	250	17	≥34	DNM.1506	HBP-02	HPV-02-M6*22	HDNM-15	HAV-02-M5*12		
S32T TDUNR/L 15	32	30	300	22	≥40							
S40U TDUNR/L 15	40	37.5	350	27	≥50							
S50V TDUNR/L 15	50	47	400	35	≥63							

TSKNR









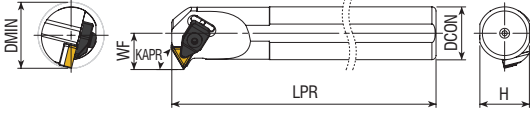
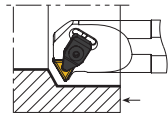

KAPR=75°

 Takım Kodu Ordering Code Bestell- Bezeichnung	Takım Ölçüleri (mm) Dimension (mm) Abmessung (mm)					Kesici Uç Insert Wendeschnei- Platte	Baskı Pabucu Wedge Clamp Spannpratze	Pabuç Vidası Clamp Screw Klemmschraube	Altık Shim Unterloge	Altık Vidası Shim Screw Schraube für Unterlage	Pul Shim Shim Ring	Anahtar Allenkey Innensech- skantschlüssel
	DCON	H	LF	WF	DMIN							
S25S TSKNR/L 12	25	23	250	17	≥32		HBP-02	HPV-02-M6*22	HSNM-12	HAV-04-M5*8	HP-01	HAL-03
S32T TSKNR/L 12	32	30	300	22	≥40	SNM.1204	HBP-02	HPV-02-M6*22	HSNM-12	HAV-02-M5*12	HP-01	HAL-03
S40U TSKNR/L 12	40	37.5	350	27	≥50							

TT-NR









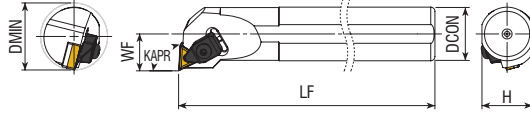
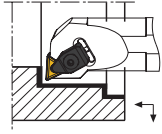







KAPR=60°

 Takım Kodu Ordering Code Bestell- Bezeichnung	Takım Ölçüleri (mm) Dimension (mm) Abmessung (mm)					Kesici Uç Insert Wendeschnei- Platte	Baskı Pabucu Wedge Clamp Spannpratze	Pabuç Vidası Clamp Screw Klemmschraube	Altık Shim Unterloge	Altık Vidası Shim Screw Schraube für Unterlage	Pul Shim Shim Ring	Anahtar Allenkey Innensech- skantschlüssel
	DCON	H	LF	WF	DMIN							
S25S TT-NR/L 16	25	23	250	17	≥32	TNM.1604	HBP-01	HPV-01-M5*22	HTNM-16	HAV-06-M5*12	HP-01	HAL-03
S32T TT-NR/L 16	32	30	300	22	≥40							

TTUNR









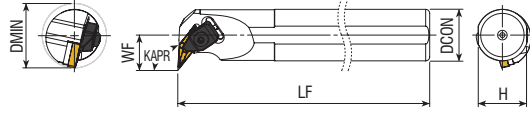
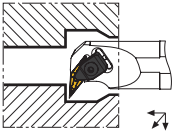

KAPR=93°

 Takım Kodu Ordering Code Bestell- Bezeichnung	Takım Ölçüleri (mm) Dimension (mm) Abmessung (mm)					Kesici Uç Insert Wendeschnei- Platte	Baskı Pabucu Wedge Clamp Spannpratze	Pabuç Vidası Clamp Screw Klemmschraube	Altık Shim Unterlage	Altık Vidası Shim Screw Schraube für Unterlage	Pul Shim Shim Ring	Anahtar Allenkey Innensech- skantschlüssel
	DCON	H	LF	WF	DMIN							
S25S TTUNR/L 16	25	23	250	17	≥32	 TNM.1604	 HBP-01	 HPV-01-M5*22	 HTNM-16	 HAV-06-M5*12	 HP-01	 HAL-03
S32T TTUNR/L 16	32	30	300	22	≥40							
S25S TTUNR/L 22	25	23	250	17	≥32	 TNM.2204	 HBP-02	 HPV-02-M6*22	 HTNM-22	 HAV-02-M5*12	 HP-01	 HAL-03
S32T TTUNR/L 22	32	30	300	22	≥40							
S40U TTUNR/L 22	40	37.5	350	27	≥50							
S50V TTUNR/L 22	50	47	400	35	≥63							

TVUNR









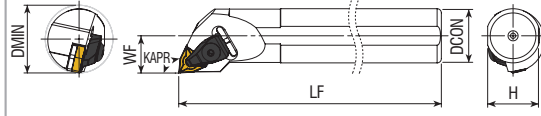
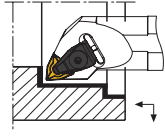





KAPR=93°

 Takım Kodu Ordering Code Bestell- Bezeichnung	Takım Ölçüleri (mm) Dimension (mm) Abmessung (mm)					Kesici Uç Insert Wendeschnei- Platte	Baskı Pabucu Wedge Clamp Spannpratze	Pabuç Vidası Clamp Screw Klemmschraube	Altık Shim Unterlage	Altık Vidası Shim Screw Schraube für Unterlage	Pul Shim Shim Ring	Anahtar Allenkey Innensech- skantschlüssel
	DCON	H	LF	WF	DMIN							
S25S TVUNR/L 16	25	23	250	20	≥36	 VNM.1604	 HBP-01	 HPV-01-M5*22	 HVBM-16	 HAV-03-M5*8	 HP-01	 HAL-03
S32T TVUNR/L 16	32	30	300	22	≥40							
S40U TVUNR/L 16	40	37.5	350	27	≥50							

TWLNR



KAPR=95°

 Takım Kodu Ordering Code Bestell- Bezeichnung	Takım Ölçüleri (mm) Dimension (mm) Abmessung (mm)					Kesici Uç Insert Wändeschneid- Platte	Baskı Pabucu Wedge Clamp Spannpratze	Pabuç Vidası Clamp Screw Klemmschraube	Altık Shim Unterlage	Altık Vidası Shim Screw Schraube für Unterlage	Pul Shim Shim Ring	Anahtar Allenkey Innensech- skantschlüssel
	DCON	H	LF	WF	DMIN							
S25S TWLNR/L 06	25	23	250	17	≥32	 WNM. 0604	 HBP-01	 HPV- 01-M5*22	 HWNM-06	HAV- 01-M3*10	 HP-01	 HAL-03
S32T TWLNR/L 06	32	30	300	22	≥40					HAV-04-M5*8		
S25S TWLNR/L 08	25	23	250	17	≥32	 WNM. 0804	 HBP-02	 HPV- 02-M6*22	 HWNM-08	HAV- 02-M5*12	 HP-01	 HAL-03
S32T TWLNR/L 08	32	30	300	22	≥40							
S40U TWLNR/L 08	40	37.5	350	27	≥50							
S50V TWLNR/L 08	50	47	400	35	≥63							
A40T TWLNR/L 08	40	37.5	300	27	≥50							
A50U TWLNR/L 08	50	47	350	35	≥63							

Perfect
Cut



PCLNR

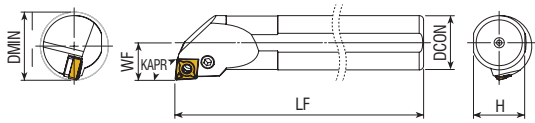
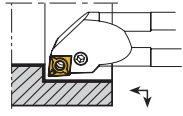

KAPR=95°

 Takım Kodu Ordering Code Bestell- Bezeichnung	Takım Ölçüleri (mm) Dimension (mm) Abmessung (mm)					Kesici Uç Insert Wendeschnei- Platte	Levyeye Lever Kniehebel	Levyeye Vidası Lever Screw Kniehebelschraube	Altılık Shim Unterlage	Altılık Yay Shim Spring Feder Für Unterlage	Anahtar Allenkey Innensch- skantschlüssel
	DCON	H	LF	WF	DMIN						
S25S PCLNR/L 12	25	23	250	17	≥32	CNM.1204	HPL-03	HLV-04-M8x16	HCNM-12	HSC-03	HAL-03
S32T PCLNR/L 12	32	30	300	22	≥40						
S40U PCLNR/L 12	40	37.5	350	27	≥50						
S50V PCLNR/L 12	50	47	400	35	≥63	CNM.1606	HPL-05	HLV-05-M8x19	HCNM-16	HSC-04	
S32T PCLNR/L 16	32	30	300	22	≥40						
S40U PCLNR/L 16	40	37.5	350	27	≥50						
S50V PCLNR/L 16	50	47	400	35	≥63	CNM.1906	HPL-06	HLV-06-M8x22	HCNM-19	HSC-05	
S40U PCLNR/L 19	40	37.5	350	27	≥50						
S50V PCLNR/L 19	50	47	400	35	≥63						

PDQNR

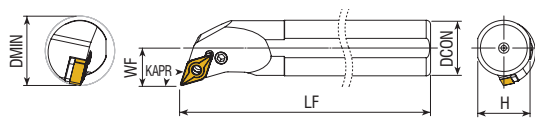

KAPR=107,5°

 Takım Kodu Ordering Code Bestell- Bezeichnung	Takım Ölçüleri (mm) Dimension (mm) Abmessung (mm)					Kesici Uç Insert Wendeschnei- Platte	Levyeye Lever Kniehebel	Levyeye Vidası Lever Screw Kniehebelschraube	Altılık Shim Unterlage	Altılık Yay Shim Spring Feder Für Unterlage	Anahtar Allenkey Innensch- skantschlüssel
	DCON	H	LF	WF	DMIN						
S20R PDQNR/L 11	20	18.3	200	13	≥25	DNM.1104	HPL-02	HLV-02-M6x14	HDCM-11	HSC-02	HAL-2.5
S25S PDQNR/L 11	25	23	250	17	≥32						
S32T PDQNR/L 15	32	30	300	22	≥40	DNM.1506	HPL-04	HLV-03-M6x17	HDNM-15	HSC-03	
S40U PDQNR/L 15	40	37.5	350	27	≥50						
S50V PDQNR/L 15	50	47	400	35	≥63						

PDXNR

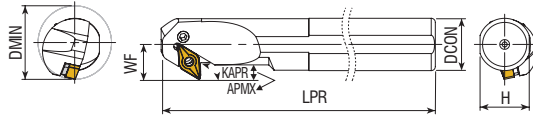
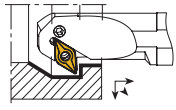

KAPR=93°

 Takım Kodu Ordering Code Bestell- Bezeichnung	Takım Ölçüleri (mm) Dimension (mm) Abmessung (mm)						Kesici Uç Insert Wendeschnei- Platte	Levyeye Lever Kniehebel	Levyeye Vidası Lever Screw Kniehebelschraube	Altılık Shim Unterlage	Altılık Yayı Shim Spring Feder Für Unterlage	Anahtar Allenkey Innensech- skantschlüssel
	DCON	H	LF	WF	APMX	DMIN						
S32T PDXNR/L 15	32	30	300	22	12	≥45						
S40U PDXNR/L 15	40	37.5	350	27	14	≥50	DNM.1506	HPL-04	HLV-04-M8x16	HDNM-15	HSC-03	HAL-03
S50V PDXNR/L 15	50	47	400	35	19	≥63						

PDUNR

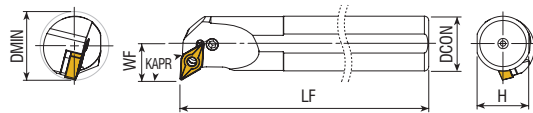
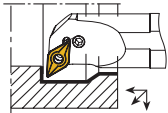

KAPR=93°







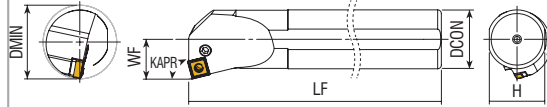
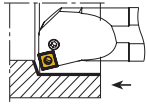



 Takım Kodu Ordering Code Bestell- Bezeichnung	Takım Ölçüleri (mm) Dimension (mm) Abmessung (mm)					Kesici Uç Insert Wendeschnei- Platte	Levyeye Lever Kniehebel	Levyeye Vidası Lever Screw Kniehebelschraube	Altılık Shim Unterlage	Altılık Yayı Shim Spring Feder Für Unterlage	Anahtar Allenkey Innensech- skantschlüssel
	DCON	H	LF	WF	DMIN						
S20R PDUNR/L 11	20	18.3	200	13	≥25						
S25S PDUNR/L 11	25	23	250	17	≥32	DNM.1104	HPL-02	HLV-02-M6x14	HDCM-11	HSC-02	HAL-2.5
S25S PDUNR/L 15	25	23	250	19	≥32			HLV-03-M6x17			
S32T PDUNR/L 15	32	30	300	22	≥40			HLV-04-M8x16			
S40U PDUNR/L 15	40	37.5	350	27	≥50	DNM.1506	HPL-04	HLV-05-M8x19	HDNM-15	HSC-03	HAL-03
S50V PDUNR/L 15	50	47	400	35	≥63						
A20P PDUNR/L 11	20	18.3	170	13	≥25			HLV-02-M6x14	HDCM-11	HSC-02	HAL-2.5
A25R PDUNR/L 11	25	23	200	17	≥32	DNM.1104	HPL-02	HLV-03-M6x17			
A32S PDUNR/L 15	32	30	250	22	≥40						
A40T PDUNR/L 15	40	37.5	300	27	≥50	DNM.1506	HPL-04	HLV-05-M8x19	HDNM-15	HSC-03	HAL-03
A50U PDUNR/L 15	50	47	350	35	≥63						



PSKNR









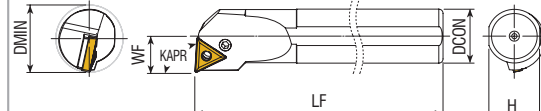
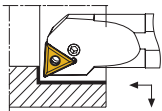



KAPR=75°

 Takım Kodu Ordering Code Bestell- Bezeichnung	Takım Ölçüleri (mm) Dimension (mm) Abmessung (mm)					Kesici Uç Insert Wendeschnei- Platte	Levyé Lever Kniehebel	Levyé Vidası Lever Screw Kniehebelschraube	Altılık Shim Unterlage	Altılık Yay Shim Spring Feder Für Unterlage	Anahtar Allenkey Innensch- skantschlüssel
	DCON	H	LF	WF	DMIN						
S25S PSKNR/L 12	25	23	250	17	≥32	 SNM.1204	 HPL-03	HLV-04-M8x16	 HSNM-12	 HSC-03	 HAL-03
S32T PSKNR/L 12	32	30	300	22	≥40						
S40U PSKNR/L 12	40	37.5	350	27	≥50						
S50V PSKNR/L 12	50	47	400	35	≥63						
S32T PSKNR/L 15	32	30	300	22	≥40	 SNM.1506	 HPL-05	HLV-06-M8x22	 HSNM-15	 HSC-04	 HAL-03
S40U PSKNR/L 15	40	37.5	350	27	≥50						
S50V PSKNR/L 15	50	47	400	35	≥63						

PTUNR









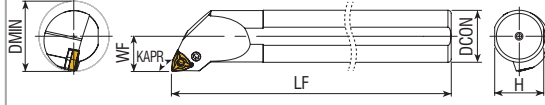
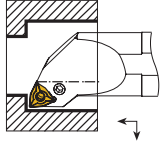





KAPR=93°

 Takım Kodu Ordering Code Bestell- Bezeichnung	Takım Ölçüleri (mm) Dimension (mm) Abmessung (mm)					Kesici Uç Insert Wendeschnei- Platte	Levyé Lever Kniehebel	Levyé Vidası Lever Screw Kniehebelschraube	Altılık Shim Unterlage	Altılık Yay Shim Spring Feder Für Unterlage	Anahtar Allenkey Innensch- skantschlüssel
	DCON	H	LF	WF	DMIN						
S16P PTUNR/L 16	16	14.8	170	11	≥20	 TNM.1604	 HPL-02	HLV-01-M6x13	 HTNM-16	 HSC-02	 HAL-2.5
S20R PTUNR/L 16	20	18.3	200	13	≥25						
S25S PTUNR/L 16	25	23	250	17	≥32						
S32T PTUNR/L 16	32	30	300	22	≥40			HLV-03-M6x17			
S40U PTUNR/L 16	40	37.5	350	27	≥50						
S32T PTUNR/L 22	32	30	300	22	≥40	 TNM.2204	 HPL-03	HLV-05-M8x19	 HTNM-22	 HSC-03	 HAL-03
S40U PTUNR/L 22	40	37.5	350	27	≥50						
S50V PTUNR/L 22	50	47	400	35	≥63						

PWLNR





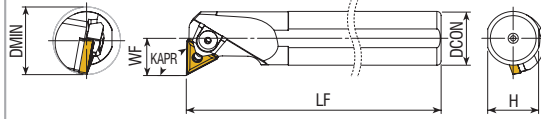
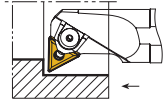

KAPR=95°

 Takım Kodu Ordering Code Bestell- Bezeichnung	Takım Ölçüleri (mm) Dimension (mm) Abmessung (mm)					Kesici Uç Insert Wändeschneid- Platte	Levye Lever Kniehebel	Levye Vidası Lever Screw Kniehebelschraube	Altık Shim Unterlage	Altık Yay Shim Spring Feder Für Unterlage	Anahtar Allenkey Innensch- schlüssel
	DCON	H	LF	WF	DMIN						
S20R PWLNR/L 06	20	18.3	200	13	≥25	 WNM.0604	 HPL-02	 HLV-02-M6x14	 HWNM-06	 HSC-02	 HAL-2.5
S25S PWLNR/L 06	25	23	250	17	≥32						
S32T PWLNR/L 06	32	30	300	22	≥40						
S25S PWLNR/L 08	25	23	250	17	≥32	 WNM.0804	 HPL-03	 HLV-05-M8x19	 HWNM-08	 HSC-03	 HAL-03
S32T PWLNR/L 08	32	30	300	22	≥40						
S40U PWLNR/L 08	40	37.5	350	27	≥50						
S50V PWLNR/L 08	50	47	400	35	≥63						

MTFNR





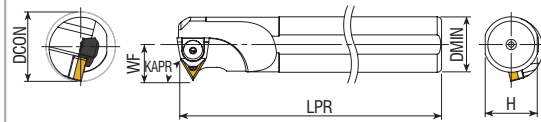
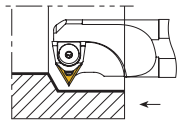

KAPR=90°

 Takım Kodu Ordering Code Bestell- Bezeichnung	Takım Ölçüleri (mm) Dimension (mm) Abmessung (mm)					Kesici Uç Insert Wendeschnei- Platte	Baskı Pabucu Wedge Clamp Spannpratze	Pabuç Vidası Clamp Screw Klemmschraube	Altlık Shim Unterloge	Pim Pin Passstift	Pul Shim Ring	Anahtar Allenkey Innensech- skantschlüssel
	DCON	H	LF	WF	DMIN							
S20R MTFNR/L 16	20	18.3	200	14	≥25	 TNM.1604	HBP-07	HPV-04-M5*15	-	HPM-04	-	 HAL-03
S25S MTFNR/L 16	25	23	250	17	≥32		HBP-08	HPV-02-M6*22	HTNM-16	HPM-07	HP-01	
S32T MTFNR/L 16	32	30	300	22	≥40					HPM-01		
S40U MTFNR/L 16	40	37.5	350	27	≥50	 TNM.2204	HBP-08	HPV-02-M6*22	HTNM-22	HPM-02		
S32T MTFNR/L 22	32	30	300	22	≥40							
S40U MTFNR/L 22	40	37.5	350	27	≥50							
S50V MTFNR/L 22	50	47	400	35	≥63							

MT-NR









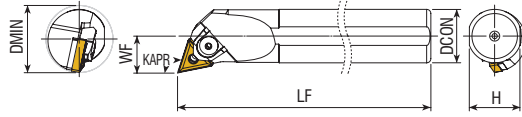
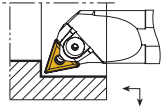

KAPR=60°

 Takım Kodu Ordering Code Bestell- Bezeichnung	Takım Ölçüleri (mm) Dimension (mm) Abmessung (mm)					Kesici Uç Insert Wendeschnei- Platte	Baskı Pabucu Wedge Clamp Spannpratze	Pabuç Vidası Clamp Screw Klemmschraube	Altlık Shim Unterloge	Pim Pin Passstift	Pul Shim Ring	Anahtar Allenkey Innensech- skantschlüssel
	DCON	H	LF	WF	DMIN							
S20R MT-NR/L 16	20	18.3	200	16	≥26	 TNM.1604	HBP-07	HPV-01-M5*22	-	HPM-04	-	 HAL-03
S25S MT-NR/L 16	25	23	250	17	≥32		HBP-08	HPV-02-M6*22	HTNM-16	HPM-07	HP-01	
S32T MT-NR/L 16	32	30	300	22	≥40					HPM-01		
S40U MT-NR/L 16	40	37.5	350	27	≥50	 TNM.2204	HBP-08	HPV-02-M6*22	HTNM-22	HPM-02		
S32T MT-NR/L 22	32	30	300	24	≥40							
S40U MT-NR/L 22	40	37.5	350	27	≥50							
S50U MT-NR/L 22	50	47	350	35	≥63							

MTQNR









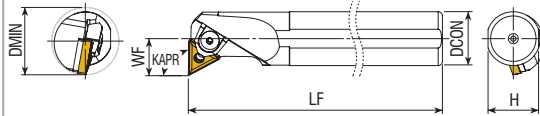
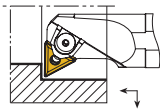

KAPR=107,5°

 Takım Kodu Ordering Code Bestell- Bezeichnung	Takım Ölçüleri (mm) Dimension (mm) Abmessung (mm)					Kesici Uç Insert Wendeschnei- Platte	Baskı Pabucu Wedge Clamp Spannpratze	Pabuç Vidası Clamp Screw Klemmschraube	Altlık Shim Unterloge	Pim Pin Passstift	Pul Shim Shim Ring	Anahtar Allenkey Innensech- skantschlüssel	
	DCON	H	LF	WF	DMIN								
S20R MTQNR/L 16	20	18.3	200	13	≥25	TNM.1604	HBP-07	HPV-04-M5*15	-	HPM-04	-	-	
S25S MTQNR/L 16	25	23	250	17	≥32					HPM-07			
S32T MTQNR/L 16	32	30	300	22	≥40					HTNM-16			HPM-01
S40U MTQNR/L 16	40	37.5	350	27	≥50					HP-01			HAL-03
S32T MTQNR/L 22	32	30	300	22	≥40	TNM.2204	HBP-08	HPV-02-M6*22	HTNM-22	HPM-02	HP-01	-	
S40U MTQNR/L 22	40	37.5	350	27	≥50					HPM-02			
S50V MTQNR/L 22	50	47	400	35	≥63								

MTUNR



KAPR=93°

 Takım Kodu Ordering Code Bestell- Bezeichnung	Takım Ölçüleri (mm) Dimension (mm) Abmessung (mm)					Kesici Uç Insert Wendeschnei- Platte	Baskı Pabucu Wedge Clamp Spannpratze	Pabuç Vidası Clamp Screw Klemmschraube	Altlık Shim Unterloge	Pim Pin Passstift	Pul Shim Shim Ring	Anahtar Allenkey Innensech- skantschlüssel	
	DCON	H	LF	WF	DMIN								
S20R MTUNR/L 16	20	18.3	200	13	≥25	TNM.1604	HBP-07	HPV-04-M5*15	-	HPM-04	-	-	
S25S MTUNR/L 16	25	23	250	17	≥32					HPM-07			
S32T MTUNR/L 16	32	30	300	22	≥40					HTNM-16			HPM-01
S40U MTUNR/L 16	40	37.5	350	27	≥50					HP-01			HAL-03
S50V MTUNR/L 16	50	47	400	35	≥63	TNM.2204	HBP-08	HPV-02-M6*22	HTNM-22	HPM-02	HP-01	-	
S32T MTUNR/L 22	32	30	300	22	≥40					HPM-02			
S40U MTUNR/L 22	40	37.5	350	27	≥50								
S50V MTUNR/L 22	50	47	400	35	≥63								



MWLNR

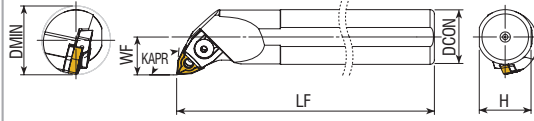
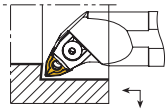

KAPR=95°

 Takım Kodu Ordering Code Bestell- Bezeichnung	Takım Ölçüleri (mm) Dimension (mm) Abmessung (mm)					Kesici Uç Insert Wendeschnei- Platte	Baskı Pabucu Wedge Clamp Spannpratze	Pabuç Vidası Clamp Screw Klemmschraube	Altık Shim Unterloge	Pim Pin Passtift	Pul Shim Ring	Anahtar Allenkey Innensech- skantschlüssel
	DCON	H	LF	WF	DMIN							
S16P MWLNR/L06	16	14.8	170	11	≥20	WNM.0604	HBP-05	HPV-04-M5*15	-	HPM-05	-	HAL-03
S20R MWLNR/L06	20	18.3	200	13	≥25					HPM-03		
S25S MWLNR/L06	25	23	250	17	≥32					HPM-06		
S25S MWLNR/L08	25	23	250	17	≥32	WNM.0804	HBP-06	HPV-02-M6*22	HWNM-08	HPM-02	HP-01	
S32T MWLNR/L08	32	30	300	22	≥40							
S40U MWLNR/L08	40	37.5	350	27	≥50							

CKUNR

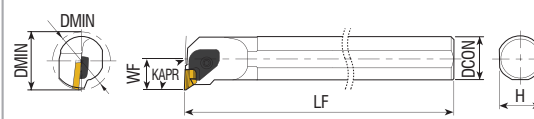
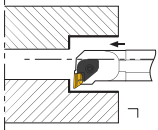

KAPR=93°

 Takım Kodu Ordering Code Bestell- Bezeichnung	Takım Ölçüleri (mm) Dimension (mm) Abmessung (mm)					Kesici Uç Insert Wendeschnei- Platte	Baskı Pabucu Wedge Clamp Spannpratze	Pabuç Vidası Clamp Screw Klemmschraube	Altık Shim Unterloge	Altık Vidası Shim Screw Schraube für Unterlage	Pul Shim Ring	Anahtar Allenkey Innensech- skantschlüssel
	DCON	H	LF	WF	DMIN							
S25S CKUNR/L16	25	23	250	19	≥38	KNUX 1604	HBP-09-R HBP-09-L	HPV-05-M6*22	HKNR-16 HKNL-16	HAV-01-M3*10	HP-01	HAL-04
S32T CKUNR/L16	32	30	300	22	≥40							
S40U CKUNR/L16	40	37.5	350	27	≥50							
S50V CKUNR/L16	50	47	400	35	≥63							

Perfect
Cut





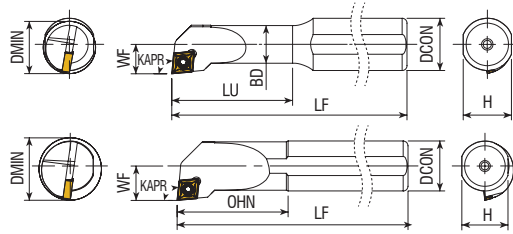
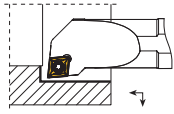

**EXTRA
POWER**



SCLCR



KAPR=95°





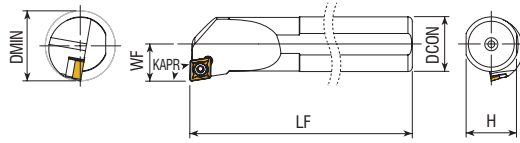
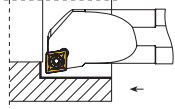

 Takım Kodu Ordering Code Bestell- Bezeichnung	Takım Ölçüleri (mm) Dimension (mm) Abmessung (mm)							Kesici Uç Insert Wendeschnei- Platte	Sıkma Vidası Screw Schraube	Altık Shim Unterlage	Altık Vidası Shim Screw Schraube Für Unterlage	Tork Anahtar Torx Key Torx Schlüssel
	DCON	BD	H	LU = OHN	LF	WF	DMIN					
S0508H SCLCR/L 03	8	5	7.3	15	100	2.5	≥5	CC.T 0301.	1060-M1.6x3.2			
S0608H SCLCR/L 03	8	5	7.3	18	100	3	≥6	CC.T 0301.	1060-M1.6x3.2			HTA-T06
S0708H SCLCR/L 04	8	6	7.3	18	100	3.5	≥7	CC.T 0401.	1060-M2x4			
S0608H SCLCR/L 06	8	6	7.3	25	100	4.5	≥8		1060-M2.5x5			
S08H SCLCR/L 06	8	8	7.3	20	100	6	≥11			-	-	
S10K SCLCR/L 06	10	10	9	25	125	7	≥13	CCT 0602.				HTA-T08
S12K SCLCR/L 06	12	12	11	25	125	9	≥16		1060-M2.5x6			
S1216P SCLCR/L 06	16	11.5	14.8	37	170	9	≥16					
S16P SCLCR/L 06	16	16	14.8	35	170	11	≥20					
S12K SCLCR/L 09	12	12	11	30	125	9	≥16					
S1416P SCLCR/L 09	16	14	14.8	45	170	9.5	≥17					
S16P SCLCR/L 09	16	16	14.8	35	170	11	≥20		1060-M3.5x9	-	-	
S1620R SCLCR/L 09	20	16	18.3	50	200	11	≥20	CC.T 09T3				HTA-T15
S20R SCLCR/L 09	20	20	18.3	40	200	13	≥25					
S25S SCLCR/L 09	25	25	23	50	250	17	≥32		1060-M3.5x12	HCCM-09	HBV-01- M3.5x8	
S32T SCLCR/L 09	32	32	30	60	300	22	≥40					
S25S SCLCR/L 12	25	25	23	50	250	17	≥32		1060-M4.5x12	HCCM-12	HBV-03- M4.5x8	HTA-T20
S32T SCLCR/L 12	32	32	30	60	300	22	≥40	CC.T 1204				
S40U SCLCR/L 12	40	40	37.5	70	350	27	≥50		1060-M4.5x16		HBV-04-M4.5x13	
A08H SCLCR/L 06	8	8	7.3	20	100	6	≥11					
A10H SCLCR/L 06	10	10	9	25	100	7	≥13	CC.T 0602	1060-M2.5x6	-	-	HTA-T08
A12H SCLCR/L 06	12	12	11	25	100	9	≥16					
A16M SCLCR/L 09	16	16	14.8	35	150	11	≥20		1060-M3.5x9	-	-	-
A20P SCLCR/L 09	20	20	18.3	40	170	13	≥25					
A25R SCLCR/L 09	25	25	23	50	200	17	≥32	CC.T 09T3	1060-M3.5x12	HCCM-09	HBV-01- M3.5x8	HTA-T15
A32S SCLCR/L 09	32	32	30	60	250	22	≥40					
A25R SCLCR/L 12	25	25	23	50	200	17	≥32	CC.T 1204	1060-M4.5x12	HCCM-12	HBV-03-M4.5x8	HTA-T20



SCFCR







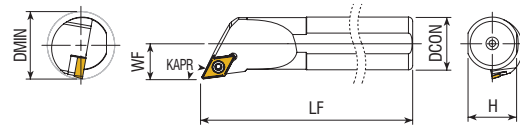
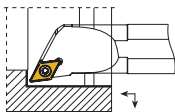

KAPR=90°

 Takım Kodu Ordering Code Bestell- Bezeichnung	Takım Ölçüleri (mm) Dimension (mm) Abmessung (mm)					Kesici Uç Insert Wendeschnei Platte	Sıkma Vidası Screw Schraube	Altlık Shim Unterlage	Altlık Vidası Shim Screw Schraube Für Unterlage	Tork Anahtar Torx Key Torx Schlüssel
	DCON	H	LF	WF	DMIN					
S08H SCFCR/L 06	8	7.3	100	6	≥11					
S10K SCFCR/L 06	10	9	125	7	≥13	CC.T 0602	1045-M2.5x6	-	-	HTA-T08
S12K SCFCR/L 06	12	11	125	9	≥16					
S12K SCFCR/L 09	12	11	125	9	≥16					
S16P SCFCR/L 09	16	14.8	170	11	≥20					
S20R SCFCR/L 09	20	18.3	200	13	≥25	CC.T 09T3.	1060-M3.5x9	-	-	HTA-T15
S25S SCFCR/L 09	25	23	250	17	≥32		1060-M3.5x12	HCCM-09	HBV-01-M3.5x8	
S25S SCFCR/L 12	25	23	250	17	≥32					
S32T SCFCR/L 12	32	30	300	22	≥40	CC.T 1204	1060-M4.5x12	HCCM-12	HBV-03-M4.5x8	HTA-T20
S40U SCFCR/L 12	40	37.5	350	27	≥50		1060-M4.5x16		HBV-04-M4.5x13	
A08H SCFCR/L 06	8	7.3	100	6	≥11	CC.T 0602	1060-M2.5x6	-	-	HTA-T08

SDPCR







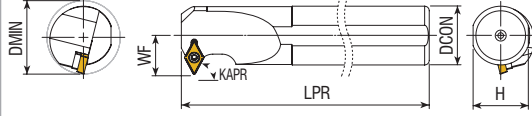
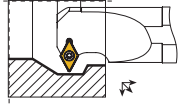

KAPR=117,5°

 Takım Kodu Ordering Code Bestell- Bezeichnung	Takım Ölçüleri (mm) Dimension (mm) Abmessung (mm)					Kesici Uç Insert Wendeschnei Platte	Sıkma Vidası Screw Schraube	Altlık Shim Unterlage	Altlık Vidası Shim Screw Schraube Für Unterlage	Tork Anahtar Torx Key Torx Schlüssel
	DCON	H	LF	WF	DMIN					
S10K SDPCR/L 07	10	9	125	7	≥13	DC.T 0702	1060-M2.5x6	-	-	HTA-T08
S12K SDPCR/L 07	12	11	125	9	≥16					
S16P SDPCR/L 11	16	14.8	170	11	≥20		1060-M3.5x9	-	-	HTA-T15
S20R SDPCR/L 11	20	18.3	200	13	≥25	DC.T 11T3	1060-M3.5x12			
S25S SDPCR/L 11	25	23	250	17	≥32			HDCM-11	HBV-01-M3.5x8	

SD-CR







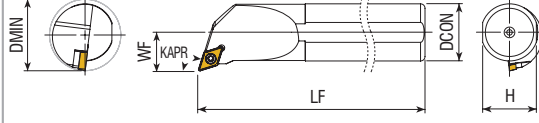
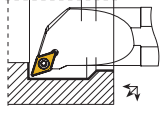

KAPR=62,5°

 Takım Kodu Ordering Code Bestell- Bezeichnung	Takım Ölçüleri (mm) Dimension (mm) Abmessung (mm)					Kesici Uç Insert Wendeschnei- Platte	Sıkma Vidası Screw Schraube	Altık Shim Unterlage	Altık Vidası Shim Screw Schraube Für Unterlage	Tork Anahtar Torx Key Torx Schlüssel
	DCON	H	LPR	WF	DMIN					
S10K SD-CR/L 07	10	9	125	7	≥14	DC.T 0702	1060-M2.5x6	-	-	HTA-T08
S12K SD-CR/L 07	12	11	125	9	≥16					
S16P SD-CR/L 07	16	14.8	170	11	≥20					
S20R SD-CR/L 07	20	18.3	200	13	≥25	DC.T 11T3.	1060-M3.5x12	-	-	HTA-T15
S16P SD-CR/L 11	16	14.8	170	14	≥22					
S20R SD-CR/L 11	20	18.3	200	15	≥25					
S25S SD-CR/L 11	25	23	250	18	≥32					
S32T SD-CR/L 11	32	30	300	22	≥40	1060-M3.5x14	HDCM-11	HBV-02-M3.5x11		
S40U SD-CR/L 11	40	37.5	350	27	≥50					

SDQCR



KAPR=107,5°

 Takım Kodu Ordering Code Bestell- Bezeichnung	Takım Ölçüleri (mm) Dimension (mm) Abmessung (mm)					Kesici Uç Insert Wendschnei Platte	Sıkma Vidası Screw Schraube	Altlık Shim Unterlage	Altlık Vidası Shim Screw Schraube Für Unterlage	Tork Anahtar Torx Key Torx Schlüssel	
	DCON	H	LF	WF	DMIN						
S10K SDQCR/L 07	10	9	125	7	≥13	DC.T 0702	1060-M2.5x6	-	-	HTA-T08	
S12K SDQCR/L 07	12	11	125	9	≥16						
S16P SDQCR/L 07	16	14.8	170	11	≥20						
S20R SDQCR/L 07	20	18.3	200	13	≥25						
S16P SDQCR/L 11	16	14.8	170	11	≥20	DC.T11T3	1060-M3.5x9	HDCM-11	-	HTA-T15	
S20R SDQCR/L 11	20	18.3	200	13	≥25		1060-M3.5x12				
S25S SDQCR/L 11	25	23	250	17	≥32		1060-M3.5x14				HBV-01-M3.5x8
S32T SDQCR/L 11	32	30	300	22	≥40						HBV-02-M3.5x11
S40U SDQCR/L 11	40	37.5	350	27	≥50						
A10H SDQCR/L 07	10	9	100	7	≥13	DC.T 0702	1060-M2.5x6	-	-	HTA-T08	
A12H SDQCR/L 07	12	11	100	9	≥16						
A16M SDQCR/L 07	16	14.8	150	11	≥20						
A20P SDQCR/L 07	20	18.3	170	13	≥25						
A16M SDQCR/L 11	16	14.8	150	11	≥20	DC.T11T3	1060-M3.5x9	HDCM-11	-	HTA-T15	
A20P SDQCR/L 11	20	18.3	170	13	≥25		1060-M3.5x12				
A25R SDQCR/L 11	25	23	200	17	≥32		1060-M3.5x14				HBV-01-M3.5x8
A32S SDQCR/L 11	32	30	250	22	≥40						HBV-02-M3.5x11





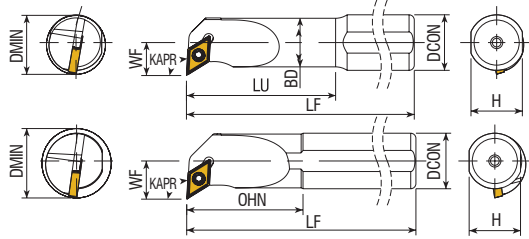
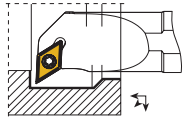



SDUCR



KAPR=93°







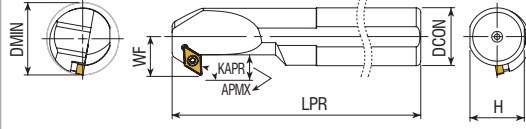
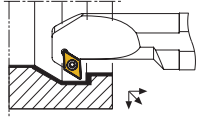

 Takım Kodu Ordering Code Bestell- Bezeichnung	Takım Ölçüleri (mm) Dimension (mm) Abmessung (mm)							Kesici Uç Insert Wendeschnei- Platte	Sıkma Vidası Screw Schraube	Altık Shim Unterlage	Altık Vidası Shim Screw Schraube Für Unterlage	Tork Anahtar Torx Key Torx Schlüssel
	DCON	BD	H	LU = OHN	LF	WF	DMIN					
S0810K SDUCR/L 07	10	8	9	30	125	8	≥13					
S10K SDUCR/L 07	10	10	9	25	125	8	≥13					
S12K SDUCR/L 07	12	12	11	25	125	9	≥16					
S1216P SDUCR/L 07	16	11.5	14.8	37	170	9	≥16	DC.T 0702	1060-M2.5x6	-	-	HTA-T08
S1416P SDUCR/L 07	16	14	14.8	45	170	9.5	≥17					
S16P SDUCR/L 07	16	16	14.8	35	170	11	≥20					
S20R SDUCR/L 07	20	20	18.3	40	200	13	≥25					
S1416P SDUCR/L 11	16	14	14.8	45	170	11	≥18					
S16P SDUCR/L 11	16	16	14.8	35	170	11	≥20		1060-M3.5x9			
S1620R SDUCR/L 11	20	16	18.3	50	200	11	≥20					
S20R SDUCR/L 11	20	20	18.3	40	200	13	≥25	DC.T 11T3	1060-M3.5x12		HBV-01-M3.5x8	HTA-T15
S25S SDUCR/L 11	25	25	23	50	250	17	≥32			HDCM-11		
S32T SDUCR/L 11	32	32	30	60	300	22	≥40				HBV-02-M3.5x11	
S40U SDUCR/L 11	40	40	37.5	70	350	27	≥50		1060-M3.5x14			
S50V SDUCR/L 11	50	50	47	80	400	35	≥63					
A0810H SDUCR/L 07	10	8	9	30	100	8	≥13					
A10H SDUCR/L 07	10	10	9	25	100	8	≥13					
A12H SDUCR/L 07	12	12	11	25	100	9	≥16	DC.T 0702	1060-M2.5x6	-	-	HTA-T08
A16M SDUCR/L 07	16	16	14.8	35	150	11	≥20					
A20P SDUCR/L 07	20	20	18.3	40	170	13	≥25					
A16M SDUCR/L 11	16	16	14.8	35	150	11	≥20		1060-M3.5x9			
A20P SDUCR/L 11	20	20	18.3	40	170	13	≥25	DC.T 11T3	1060-M3.5x12			HTA-T15
A25R SDUCR/L 11	25	25	23	50	200	17	≥32			HDCM-11	HBV-01-M3.5x8	
A32S SDUCR/L 11	32	32	30	60	250	22	≥40		1060-M3.5x14		HBV-02-M3.5x11	



SDXCR







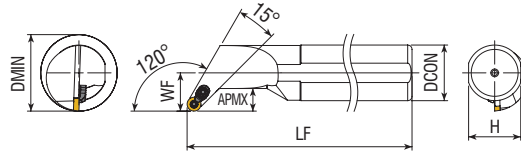
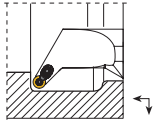

KAPR=93°

 Takım Kodu Ordering Code Bestell- Bezeichnung	Takım Ölçüleri (mm) Dimension (mm) Abmessung (mm)						Kesici Uç Insert Wendeschnei Platte	Sıkma Vidası Screw Schraube	Altlık Shim Unterlage	Altlık Vidası Shim Screw Schraube Für Unterlage	Tork Anahtar Torx Key Torx Schlüssel
	DCON	H	LPR	WF	APMX	DMIN					
S12K SDXCR/L 07	12	11	125	9	4.5	≥16	DC.T 0702	1060-M2.5x6	-	-	HTA-T08
S16P SDXCR/L 07	16	14.8	170	11	6.5	≥20					
S20R SDXCR/L 07	20	18.3	200	13	6.5	≥25					
S16P SDXCR/L 11	16	14.8	170	11	6.5	≥20	DC.T11T3.	1060-M3.5x12	-	-	HTA-T15
S20R SDXCR/L 11	20	18.3	200	14	7.5	≥25					
S25S SDXCR/L 11	25	23	250	17	9	≥32					
S32T SDXCR/L 11	32	30	300	22	12.5	≥40					
S40U SDXCR/L 11	40	37.5	350	27	14.5	≥50					
A12H SDXCR/L 07	12	11	100	9	4.5	≥16	DC.T 0702	1060-M2.5x6	-	-	HTA-T08
A16M SDXCR/L 07	16	14.8	150	11	6.5	≥20					
A20P SDXCR/L 07	20	18.3	170	13	6.5	≥25					
A16M SDXCR/L 11	16	14.8	150	11	7.5	≥20	DC.T11T3	1060-M3.5x12	-	-	HTA-T15
A20P SDXCR/L 11	20	18.3	170	14	7.5	≥25					
A25R SDXCR/L 11	25	23	200	17	9	≥32					
A32S SDXCR/L 11	32	30	250	22	12.5	≥40					



SRGCR







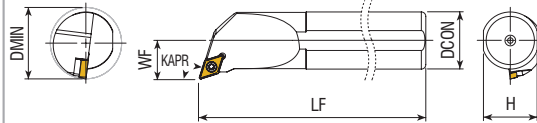
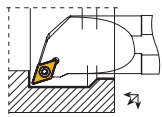

 Takım Kodu Ordering Code Bestell- Bezeichnung	Takım Ölçüleri (mm) Dimension (mm) Abmessung (mm)						Kesici Uç Insert Wendeschnei- Platte	Sıkma Vidası Screw Schraube	Altık Shim Unterlage	Altık Vidası Shim Screw Schraube Für Unterlage	Tork Anahtar Torx Key Torx Schlüssel
	DCON	H	LPR	WF	APMX	DMIN					
S16P SRGCR/L 08	16	14.8	170	11	7	≥22	RCM.0803	1060-M3x8	-	-	HTA-T08
S20R SRGCR/L 08	20	18.3	200	13	7	≥26					
S25S SRGCR/L 08	25	23	250	17	9.5	≥34					
S32T SRGCR/L 08	32	30	300	22	13	≥44					
S40U SRGCR/L 08	40	37.5	350	27	15	≥54					
A16M SRGCR/L 08	16	14.8	150	11	7	≥22					
A20P SRGCR/L 08	20	18.3	170	13	7	≥26					
A25R SRGCR/L 08	25	23	200	17	9.5	≥34					
A32S SRGCR/L 08	32	30	250	22	13	≥44					
A40T SRGCR/L 08	40	37.5	300	27	15	≥54					

SSSCR



KAPR=45°









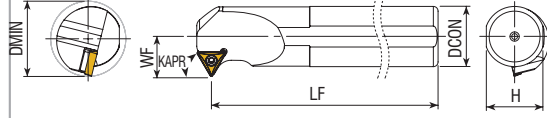
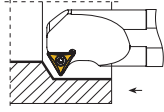



 Takım Kodu Ordering Code Bestell- Bezeichnung	Takım Ölçüleri (mm) Dimension (mm) Abmessung (mm)					Kesici Uç Insert Wendeschnei- Platte	Sıkma Vidası Screw Schraube	Altık Shim Unterlage	Altık Vidası Shim Screw Schraube Für Unterlage	Tork Anahtar Torx Key Torx Schlüssel
	DCON	H	LPR	WF	DMIN					
S16P SSSCR/L 09	16	14.8	170	11	≥20	SCT.09T3..	1060-M3.5x9	-	-	HTA-T15
S20R SSSCR/L 09	20	18.3	200	13	≥25		1060-M3.5x12			
S25S SSSCR/L 09	25	23	250	17	≥32	SCT.1204..	1060-M4.5x12	HSCM-09	HBV-01-M3.5x8	HTA-T20
S25S SSSCR/L 12	25	23	250	17	≥32			1060-M4.5x16	HBV-03-M4.5x8	
S32T SSSCR/L 12	32	30	300	22	≥40		HSCM-12	HBV-04-M4.5x13		
S40U SSSCR/L 12	40	37.5	350	27	≥50					



ST-CR



KAPR=60°





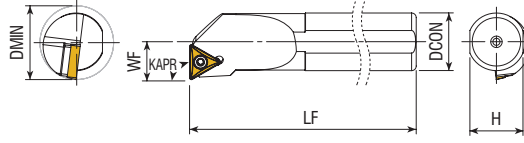
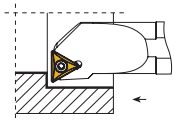

 Takım Kodu Ordering Code Bestell- Bezeichnung	Takım Ölçüleri (mm) Dimension (mm) Abmessung (mm)					Kesici Uç Insert Wendeschnei- Platte	Sıkma Vidası Screw Schraube	Altlık Shim Unterlage	Altlık Vidası Shim Screw Schraube Für Unterlage	Tork Anahtar Torx Key Torx Schlüssel
	DCON	H	LF	WF	DMIN					
S12K ST-CR/L 11	12	11	125	9	≥17	TC.T 1102.	1060-M2.5x6			HTA-T08
S16P ST-CR/L 11	16	14.8	170	11	≥20					
S20R ST-CR/L 11	20	18.3	200	13	≥25					
S16P ST-CR/L 16	16	14.8	170	11	≥20	TC.T 16T3.	1060-M3.5x9			HTA-T15
S20R ST-CR/L 16	20	18.3	200	13	≥25		1060-M3.5x12			
S25S ST-CR/L 16	25	23	250	17	≥32					
S32T ST-CR/L 16	32	30	300	22	≥40					
S40U ST-CR/L 16	40	37.5	350	27	≥50		1060-M3.5x14			

STFCR



KAPR=90°







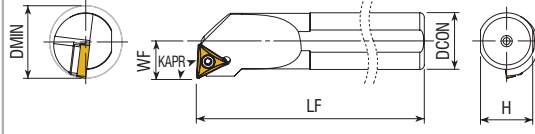
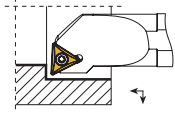

 Takım Kodu Ordering Code Bestell- Bezeichnung	Takım Ölçüleri (mm) Dimension (mm) Abmessung (mm)					Kesici Uç Insert Wändeschnei- Platte	Sıkma Vidası Screw Schraube	Aitlik Shim Unterlage	Aitlik Vidası Shim Screw Schraube Für Unterlage	Tork Anahtar Torx Key Torx Schlüssel
	DCON	H	LF	WF	DMIN					
S0610F STFCR/L 06	10	9	80	4.5	≥08	TC.T 06T1.	1060-M2x4			HTA-T06
S08H STFCR/L 06	8	7.3	100	6	≥11					
S10K STFCR/L 09	10	9	125	7	≥13	TC.T 0902.	1060-M2.2x5			HTA-T07
S12K STFCR/L 09	12	11	125	9	≥17					
S12K STFCR/L 11	12	11	125	9	≥17	TC.T 1102.	1060-M2.5x6			HTA-T08
S16P STFCR/L 11	16	14.8	170	11	≥20					
S20R STFCR/L 11	20	18.3	200	13	≥25	TC.T 1102.	1060-M3.5x9	-	-	HTA-T15
S16P STFCR/L 16	16	14.8	170	11	≥20					
S20R STFCR/L 16	20	18.3	200	13	≥25	TC.T 16T3.	1060-M3.5x14			HTA-T15
S25S STFCR/L 16	25	23	250	17	≥32					
S32T STFCR/L 16	32	30	300	22	≥40	TC.T 1102.	1060-M2.5x6			HTA-T08
S40U STFCR/L 16	40	37.5	350	27	≥50					
A10H STFCR/L 11	10	9	100	7	≥13	TC.T 1102.	1060-M2.5x6			HTA-T08
A12H STFCR/L 11	12	11	100	9	≥17					
A16M STFCR/L 11	16	14.8	150	11	≥20					

STUCR



KAPR=93°

 Takım Kodu Ordering Code Bestell- Bezeichnung	Takım Ölçüleri (mm) Dimension (mm) Abmessung (mm)					Kesici Uç Insert Wendschnei Platte	Sıkma Vidası Screw Schraube	Altlık Shim Unterlage	Altlık Vidası Shim Screw Schraube Für Unterlage	Tork Anahtar Torx Key Torx Schlüssel
	DCON	H	LF	WF	DMIN					
S10K STUCR/L 09	10	9	125	7	≥13	TC.T 0902.	1060-M2.2x5			HTA-T06
S12K STUCR/L 09	12	11	125	9	≥16					
S12K STUCR/L 11	12	11	125	9	≥17	TC.T 1102.	1060-M2.5x6			HTA-T08
S16P STUCR/L 11	16	14.8	170	11	≥20					
S20R STUCR/L 11	20	18.3	200	13	≥25	TC.T 16T3.	1060-M3.5x9 1060-M3.5x12			HTA-T15
S16P STUCR/L 16	16	14.8	170	11	≥20					
S20R STUCR/L 16	20	18.3	200	13	≥25	TC.T 16T3.	1060-M3.5x14			HTA-T15
S25S STUCR/L 16	25	23	250	17	≥32					
S32T STUCR/L 16	32	30	300	22	≥40	TC.T 16T3.	1060-M3.5x14			HTA-T15
S40U STUCR/L 16	40	37.5	350	27	≥50					
A10H STUCR/L 09	10	9	100	7	≥13	TC.T 0902.	1060-M2.2x5			HTA-T06
A12H STUCR/L 09	12	11	100	9	≥16					
A12H STUCR/L 11	12	11	100	9	≥16	TC.T 1102.	1060-M2.5x6			HTA-T08
A16M STUCR/L 11	16	14.8	150	11	≥20					
A20P STUCR/L 11	20	18.3	170	13	≥25	TC.T 16T3.	1060-M3.5x9 1060-M3.5x12			HTA-T15
A16M STUCR/L 16	16	14.8	150	11	≥20					
A20P STUCR/L 16	20	18.3	170	13	≥25	TC.T 16T3.	1060-M3.5x14			HTA-T15
A25R STUCR/L 16	25	23	200	17	≥32					
A32S STUCR/L 16	32	30	250	22	≥40					

SVJBR

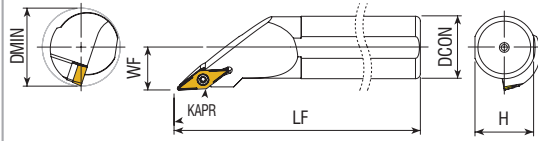
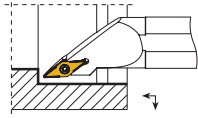







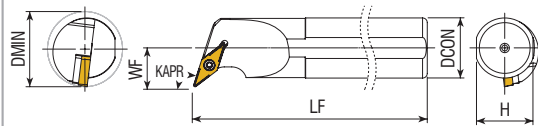
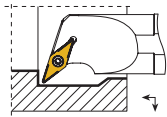





KAPR=93°

 Takım Kodu Ordering Code Bestell- Bezeichnung	Takım Ölçüleri (mm) Dimension (mm) Abmessung (mm)					Kesici Uç Insert Wendeschnei- Platte	Sıkma Vidası Screw Schraube	Aitlik Shim Unterlage	Aitlik Vidası Shim Screw Schraube Für Unterlage	Tork Anahtar Torx Key Torx Schlüssel
	DCON	H	LF	WF	DMIN					
S12K SVJBR/L 11	12	11	125	7	≥13			-	-	HTA-T08
S16P SVJBR/L 11	16	14.8	170	11	≥20					
S20R SVJBR/L 11	20	18.3	200	13	≥25			HVBM-16		HTA-T15
S25S SVJBR/L 16	25	23	250	17	≥32					
S32T SVJBR/L 16	32	30	300	22	≥40					
S40U SVJBR/L 16	40	37.5	350	27	≥50					
										

SVQBR







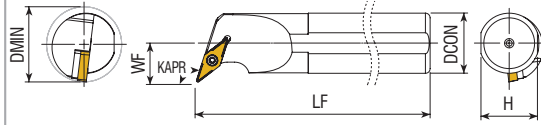
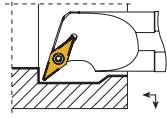

KAPR=107,5°

 Takım Kodu Ordering Code Bestell- Bezeichnung	Takım Ölçüleri (mm) Dimension (mm) Abmessung (mm)					Kesici Uç Insert Wendeschnei- Platte	Sıkma Vidası Screw Schraube	Aitlik Shim Unterlage	Aitlik Vidası Shim Screw Schraube Für Unterlage	Tork Anahtar Torx Key Torx Schlüssel
	DCON	H	LF	WF	DMIN					
S16P SVQBR/L 11	16	14.8	170	11	≥20			-	-	HTA-T08
S20R SVQBR/L 11	20	18.3	200	13	≥25					
S25S SVQBR/L 16	25	23	250	17	≥32			HVBM-16		HTA-T15
S32T SVQBR/L 16	32	30	300	22	≥40					
S40U SVQBR/L 16	40	37.5	350	27	≥50					
A25S SVQBR/L 16	25	23	250	17	≥32					
A32S SVQBR/L 16	32	30	250	22	≥40					

SVQCR





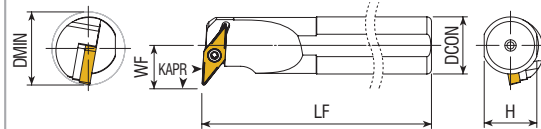
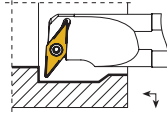

KAPR=107,5°

 Takım Kodu Ordering Code Bestell- Bezeichnung	Takım Ölçüleri (mm) Dimension (mm) Abmessung (mm)					Kesici Uç Insert Wendeschnei- Platte	Sıkma Vidası Screw Schraube	Altık Shim Unterlage	Altık Vidası Shim Screw Schraube Für Unterlage	Tork Anahtar Torx Key Torx Schlüssel
	DCON	H	LF	WF	DMIN					
S16P SVQCR/L 11	16	14.8	170	11	≥20	VC.T 1103.	1060-M2.5x6	-	-	HTA-T08
S20R SVQCR/L 11	20	18.3	200	13	≥25					
S25S SVQCR/L 16	25	23	250	17	≥32	VC.T 1604.	1060-M3.5x14	HVBM-16	HBV-01-M3.5x8	HTA-T15
S32T SVQCR/L 16	32	30	300	22	≥40				HBV-02-M3.5x11	
S40U SVQCR/L 16	40	37.5	350	27	≥50				HBV-01-M3.5x8	
A25S SVQCR/L 16	25	23	250	17	≥32				HBV-02-M3.5x11	
A32S SVQCR/L 16	32	30	250	22	≥40					

SVUBR

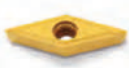





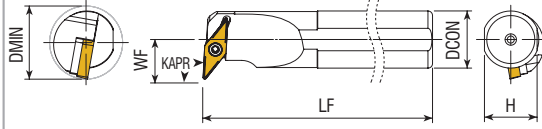
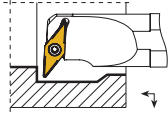

KAPR=93°

 Takım Kodu Ordering Code Bestell- Bezeichnung	Takım Ölçüleri (mm) Dimension (mm) Abmessung (mm)					Kesici Uç Insert Wendeschnei- Platte	Sıkma Vidası Screw Schraube	Altık Shim Unterlage	Altık Vidası Shim Screw Schraube Für Unterlage	Tork Anahtar Torx Key Torx Schlüssel
	DCON	H	LF	WF	DMIN					
S16P SVUBR/L 11	16	14.8	170	12.5	≥20	VB.T 1103.	1060-M2.5x6	-	-	HTA-T08
S20R SVUBR/L 11	20	18.3	200	13	≥25					
S25S SVUBR/L 16	25	23	250	19	≥32	VB.T 1604.	1060-M3.5x14	HVBM-16	HBV-01-M3.5x8	HTA-T15
S32T SVUBR/L 16	32	30	300	22	≥40				HBV-02-M3.5x11	
S40U SVUBR/L 16	40	37.5	350	27	≥50				HBV-01-M3.5x8	
A25S SVUBR/L 16	25	23	250	19	≥32				HBV-02-M3.5x11	
A32S SVUBR/L 16	32	30	250	22	≥40					

SVUCR







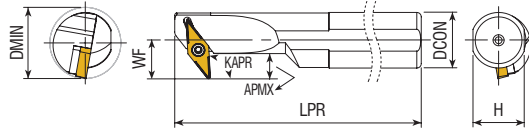
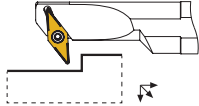

KAPR=93°

 Takım Kodu Ordering Code Bestell- Bezeichnung	Takım Ölçüleri (mm) Dimension (mm) Abmessung (mm)					Kesici Uç Insert Wendeschnei- Platte	Sıkma Vidası Screw Schraube	Altık Shim Unterlage	Altık Vidası Shim Screw Schraube Für Unterlage	Tork Anahtar Torx Key Torx Schlüssel
	DCON	H	LF	WF	DMIN					
S16P SVUCR/L 11	16	14.8	170	12.5	≥20	VC.T1103.	1060-M2.5x6	-	-	HTA-T08
S20R SVUCR/L 11	20	18.3	200	13	≥25					
S25S SVUCR/L 16	25	23	250	19	≥32	VC.T1604.	1060-M3.5x14	HVBM-16	HBV-01-M3.5x8	HTA-T15
S32T SVUCR/L 16	32	30	300	22	≥40				HBV-02-M3.5x11	
S40U SVUCR/L 16	40	37.5	350	27	≥50				HBV-01-M3.5x8	
A25R SVUCR/L 16	25	23	250	19	≥32				HBV-02-M3.5x11	
A32S SVUCR/L 16	32	30	250	22	≥40					

SVXBR



KAPR=93°

 Takım Kodu Ordering Code Bestell- Bezeichnung	Takım Ölçüleri (mm) Dimension (mm) Abmessung (mm)						Kesici Uç Insert Wendeschnei- Platte	Sıkma Vidası Screw Schraube	Altık Shim Unterlage	Altık Vidası Shim Screw Schraube Für Unterlage	Tork Anahtar Torx Key Torx Schlüssel
	DCON	H	LPR	WF	APMX	DMIN					
S16P SVXBR/L 11	16	14.8	170	12.5	7.2	≥20	VB.T1103.	1060-M2.5x6	-	-	HTA-T08
S20R SVXBR/L 11	20	18.3	200	13	5.7	≥25					
S25S SVXBR/L 16	25	23	250	19	10.2	≥32	VB.T1604.	1060-M3.5x14	HVBM-16	HBV-02-M3.5x11	HTA-T15
S32T SVXBR/L 16	32	30	300	22	11.7	≥40					
S40U SVXBR/L 16	40	37.5	350	27	14.3	≥50					

SVJCR

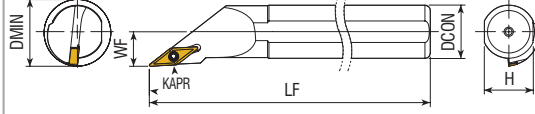
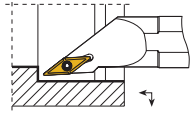







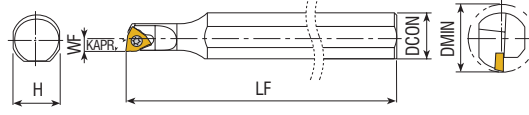
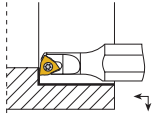

KAPR=93°

 Takım Kodu Ordering Code Bestell- Bezeichnung	Takım Ölçüleri (mm) Dimension (mm) Abmessung (mm)					Kesici Uç Insert Wendeschnei- Platte	Sıkma Vidası Screw Schraube	Altık Shim Unterlage	Altık Vidası Shim Screw Schraube Für Unterlage	Tork Anahtar Torx Key Torx Schlüssel
	DCON	H	LF	WF	DMIN					
S12K SVJCR/L 11	12	11	125	7	≥13			-	-	HTA-T08
S16P SVJCR/L 11	16	14.8	170	11	≥20					
S20R SVJCR/L 11	20	18.3	200	13	≥25					
S25S SVJCR/L 16	25	23	250	17	≥32			HVBM-16		HTA-T15
S32T SVJCR/L 16	32	30	300	22	≥40					
S40U SVJCR/L 16	40	37.5	350	27	≥50					
										

SWLCR





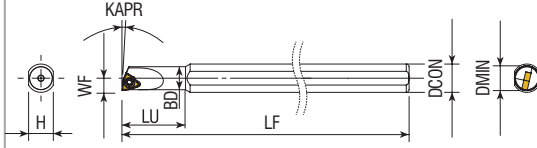
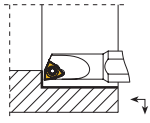

KAPR=95°

 Takım Kodu Ordering Code Bestell- Bezeichnung	Takım Ölçüleri (mm) Dimension (mm) Abmessung (mm)					Kesici Uç Insert Wendeschnei- Platte	Sıkma Vidası Screw Schraube	Altık Shim Unterlage	Altık Vidası Shim Screw Schraube Für Unterlage	Tork Anahtar Torx Key Torx Schlüssel
	DCON	H	LF	WF	DMIN					
S0608H SWLCR 03	8	7.3	100	4	≥08			-	-	HTA-T08
S0810K SWLCR 03	10	9	125	6	≥10					

SWUBR



KAPR=93°

 Takım Kodu Ordering Code Bestell- Bezeichnung	Takım Ölçüleri (mm) Dimension (mm) Abmessung (mm)							Kesici Uç Insert Wändeschnei- Platte	Sıkma Vidası Screw Schraube	Altık Shim Unterlage	Altık Vidası Shim Screw Schraube Für Unterlage	Tork Anahtar Torx Key Torx Schlüssel
	DCON	BD	H	LU	LF	DMIN	WF					
S0610H SWUBR 06	10	5	7.3	18	100	≥6	3			-	-	
S5.508H SWUBR 06	8	5	7.3	18	100	≥5.7	2.75	WBGT 060102-L	1060-M2x4	-	-	HTA-T06
S0708H SWUBR 06	8	6.5	7.3	18	100	≥7	3.5					

KYCR-ISCN Compatible
With



Perfect
Cut







Kanal Açma Takımları





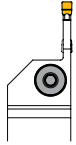

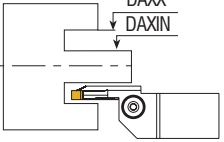
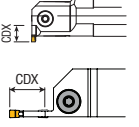
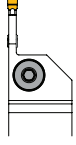
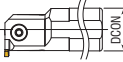
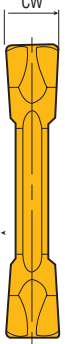

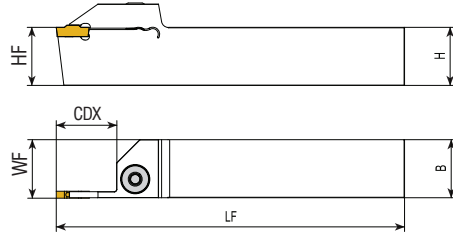
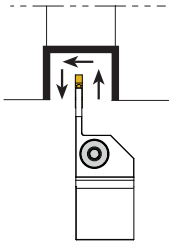













External Grooving Toolholders

Außen-stechhalter



H	AKT	K	R	2525	70 - 110	4	T22
» 1	» 2	» 3	» 4	» 5	» 6	» 7	» 9
Marka Brand Marke	Kesici Stili Cutter Style Cutter-Stil	Uç Tipi Insert Type Plattenform	Kesme Yönü Cutting Direction Schnittrichtung	Kenar Yüksekliği Edge Height Kantenhöhe	Kesme Aralığı Cutting Diameter Durchmesser für Axialeinstechen	Kenar Geniřliđi Width Edge Plattenbreite	Kesme Derinliđi Cutting Depth Maximale Schnitttiefe
huscut	Dış Çap Kanal Açma Takımı External Grooving Toolholders Außen-Stechhalter	ITG TGM. I DGN IG GRP ISCR	 L	  B		2 = 2.0 mm 3 = 3.0 mm 4 = 4.0 mm 5 = 5.0 mm 6 = 6.0 mm 8 = 8.0 mm	
	Delik İçi Kanal Açma Takımı Internal Grooving Toolholders Innen-Stechhalter	K MGM. KG KG KRLY	 R				
	Dış Çap Alın Kanal Takımları Face Grooving Toolholders Axial-Stechhalter	123 123 151.2 151.2 SNDVK	H S229 HK S224 HRN				
	L Tip Alın Kanal Açma Takımı L Type Face Grooving Toolholders Axial-Stechhalter L-Type	ZCC2 Z.BD ZCC2 Z.ED ZCC2 Z.FD ZCC2 Z.GD ZCC2 Z.HD ZCC2 Z.KD ZCC2 ZCZ	A4 A4. KNMTL				
	LKT	KYC GDM KYCR					
		TG DGM TNGLY					
		GX24 GX24. GX16 GX16. WLTR					
		SGC GCM SMTM					





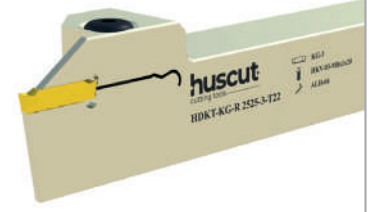
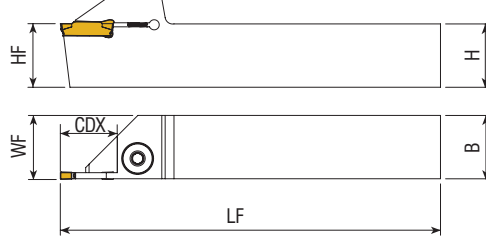
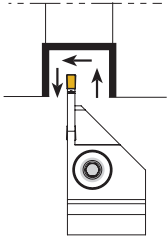

 Takım Kodu Ordering Code Bestell-Bezeichnung	Takım Ölçüleri (mm) Dimension (mm) Abmessung (mm)					Kesici Uç Insert Wendeschnei Platte	Sıkma Vidası Screw Schraube	Anahtar Allen Key Torx Schlüssel
	HF=H	B	LF	WF	CDX			
HDKT-K-R/L-1212-1.5-T15	12	12	100	12.2	15	MGM.1.5	 HPV-02-M6*22	 HAL-03
HDKT-K-R/L-1616-1.5-T15	16	16	125	16.2	15			
HDKT-K-R/L-2020-1.5-T15	20	20	125	20.2	15			
HDKT-K-R/L-1212-2-T15	12	12	100	16.3	15	MGM.2	 HPV-02-M6*22	 HAL-03
HDKT-K-R/L-1616-2-T15	16	16	125	16.3	15			
HDKT-K-R/L-2020-2-T15	20	20	125	20.3	15			
HDKT-K-R/L-2525-2-T15	25	25	150	25.3	15			
HDKT-K-R/L-3232-2-T15	32	32	170	32.3	15	MGM.3	 HPV-02-M6*22	 HAL-03
HDKT-K-R/L-1212-3-T15	12	12	100	12.3	15			
HDKT-K-R/L-1616-3-T15	16	16	125	16.3	15			
HDKT-K-R/L-2020-3-T10	20	20	125	20.3	10			
HDKT-K-R/L-2020-3-T20	20	20	125	20.3	20	MGM.4	 HKV-06-M8x1x20	 HAL-04
HDKT-K-R/L-2525-3-T15	25	25	150	25.3	15			
HDKT-K-R/L-2525-3-T22	25	25	150	25.3	22			
HDKT-K-R/L-2525-3-T25	25	25	150	25.3	25			
HDKT-K-R/L-2525-3-T40	25	25	150	25.3	40	MGM.5	 HKV-06-M8x1x20	 HAL-04
HDKT-K-R/L-3232-3-T22	32	32	170	32.3	22			
HDKT-K-R/L-2020-4-T10	20	20	125	20.4	10			
HDKT-K-R/L-2020-4-T20	20	20	125	20.4	20			
HDKT-K-R/L-2020-4-T25	20	20	125	20.4	25	MGM.6	 HKV-06-M8x1x20	 HAL-04
HDKT-K-R/L-2525-4-T15	25	25	150	25.4	15			
HDKT-K-R/L-2525-4-T22	25	25	150	25.4	22			
HDKT-K-R/L-2525-4-T25	25	25	150	25.4	25			
HDKT-K-R/L-2525-4-T40	25	25	150	25.4	40	MGM.8	 HKV-06-M8x1x20	 HAL-04
HDKT-K-R/L-3232-4-T22	32	32	170	32.4	22			
HDKT-K-R/L-2020-5-T20	20	20	125	20.5	20			
HDKT-K-R/L-2525-5-T15	25	25	150	25.5	15			
HDKT-K-R/L-2525-5-T25	25	25	150	25.5	25	MGM.6	 HKV-06-M8x1x20	 HAL-04
HDKT-K-R/L-2525-5-T40	25	25	150	25.5	40			
HDKT-K-R/L-3232-5-T25	32	32	170	32.5	25			
HDKT-K-R/L-2525-6-T25	25	25	150	25.6	25			
HDKT-K-R/L-3232-6-T25	32	32	170	32.6	25	MGM.8	 HKV-06-M8x1x20	 HAL-04
HDKT-K-R/L-3232-8-T32	32	32	170	32.8	32			

KALY Compatible With







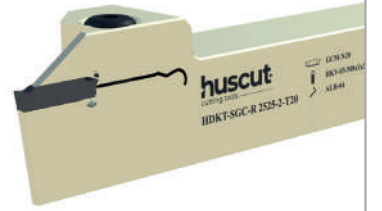
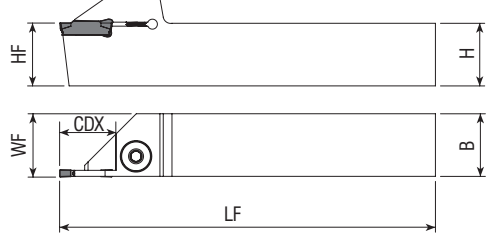
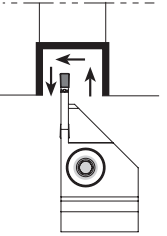

 Takım Kodu Ordering Code Bestell-Bezeichnung	Takım Ölçüleri (mm) Dimension (mm) Abmessung (mm)					Kesici Uç Insert Wendeschnei Platte	Sıkma Vidası Screw Schraube	Anahtar Allen Key Torx Schlüssel
	HF=H	B	LF	WF	CDX			
HDKT-KG-R/L-1212-2-T15	12	12	100	12.2	15	KG.2	HPV-02-M6*22	HAL-03
HDKT-KG-R/L-1616-2-T15	16	16	125	16.2	15			
HDKT-KG-R/L-2020-2-T15	20	20	125	20.2	15			
HDKT-KG-R/L-2525-2-T15	25	25	150	25.2	15	KG.3	HKV-06-M8x1x20	HAL-04
HDKT-KG-R/L-1616-3-T15	16	16	125	16.3	15			
HDKT-KG-R/L-2020-3-T20	20	20	125	20.3	20			
HDKT-KG-R/L-2525-3-T22	25	25	150	25.3	22			
HDKT-KG-R/L-2020-4-T20	20	20	125	20.4	20	KG.4	HKV-06-M8x1x20	HAL-04
HDKT-KG-R/L-2525-4-T22	25	25	150	25.4	22			
HDKT-KG-R/L-2525-5-T25	25	25	150	25.5	25			
HDKT-KG-R/L-2525-6-T25	25	25	150	25.6	25	KG.6		

KRTM Compatible With



 Takım Kodu Ordering Code Bestell-Bezeichnung	Takım Ölçüleri (mm) Dimension (mm) Abmessung (mm)					Kesici Uç Insert Wendeschnei Platte	Sıkma Vidası Screw Schraube	Anahtar Allen Key Torx Schlüssel
	HF=H	B	LF	WF	CDX			
HDKT-SGC-R/L-1212-2-T15	12	12	100	16.2	15	GCMN20	HPV-02-M6*22	HAL-03
HDKT-SGC-R/L-1616-2-T15	16	16	125	16.2	15			
HDKT-SGC-R/L-2020-2-T20	20	20	125	20.2	20			
HDKT-SGC-R/L-2525-2-T20	25	25	150	25.2	20	GCMN30	HKV-06-M8x1x20	HAL-04
HDKT-SGC-R/L-1212-3-T15	12	12	100	16.3	15			
HDKT-SGC-R/L-1616-3-T15	16	16	125	16.3	15			
HDKT-SGC-R/L-2020-3-T20	20	20	125	20.3	20			
HDKT-SGC-R/L-2525-3-T22	25	25	150	25.3	22	GCMN40		
HDKT-SGC-R/L-2525-4-T22	25	25	150	25.4	22			

SMTM Compatible With





Açıklama | Explanation | Erläuterung

R: Sağ / Right / Rechts **L: Sol** / Left / Links

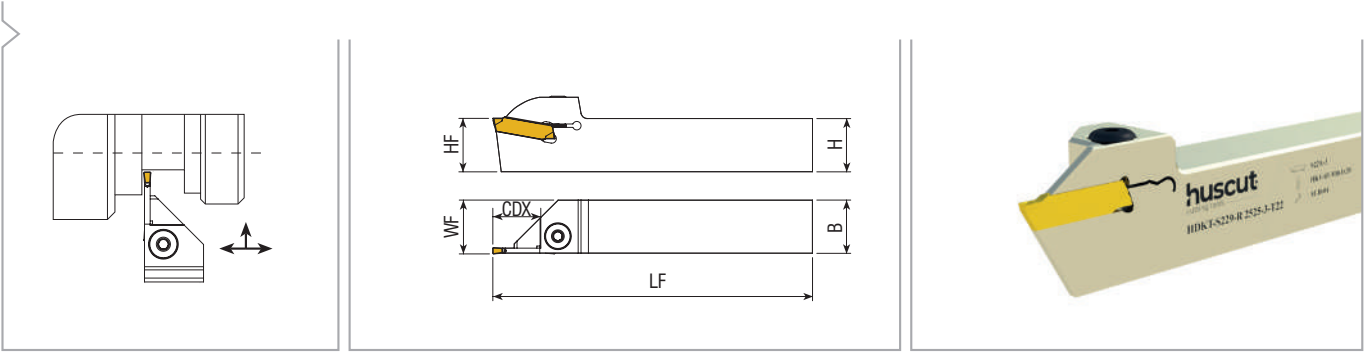





Sipariş Örneği / Ordering Example / Bestellbeispiel
1 ad./pcs./stück HDKT-K-R-2525-3-T22

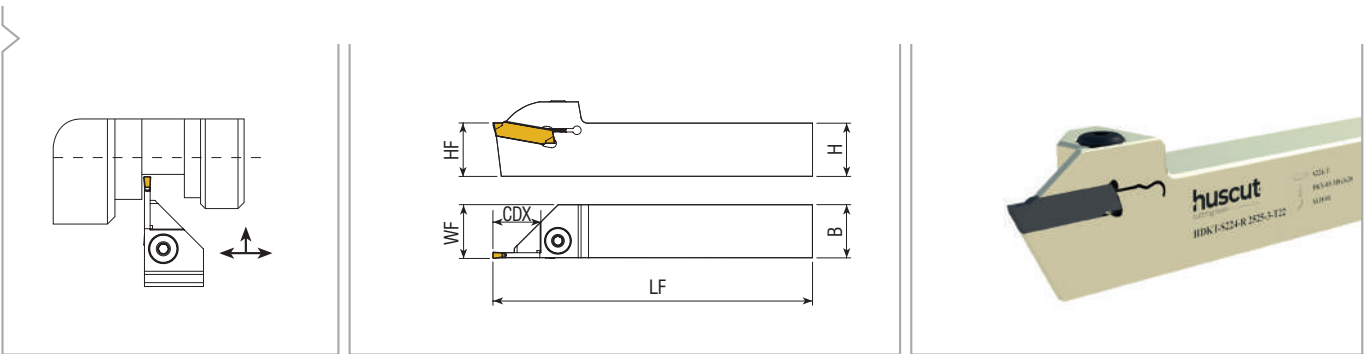

 Takım Kodu Ordering Code Bestell-Bezeichnung	Takım Ölçüleri (mm) Dimension (mm) Abmessung (mm)					Kesici Uç Insert Wendeschnei-Platte	Sıkma Vidası Screw Schraube	Anahtar Allen Key Torx Schlüssel
	HF=H	B	LF	WF	CDX			
HDKT-H-R/L-2020-2-T20	20	20	125	20.5	20	S229 - 2	HPV-02-M6*22	HAL-03
HDKT-H-R/L-2525-2-T20	25	25	150	25.5	20			
HDKT-H-R/L-2020-3-T20	20	20	125	20.5	20	S229 - 3	HKV-06-M8x1x20	HAL-04
HDKT-H-R/L-2525-3-T22	25	25	150	25.5	22			
HDKT-H-R/L-2020-4-T20	20	20	125	20.5	20	S229 - 4	HKV-06-M8x1x20	HAL-04
HDKT-H-R/L-2525-4-T22	25	25	150	25.5	22			
HDKT-H-R/L-2020-5-T20	20	20	125	20.5	20	S229 - 5	HKV-06-M8x1x20	HAL-04
HDKT-H-R/L-2525-5-T25	25	25	150	25.5	25			
HDKT-H-R/L-2525-6-T25	25	25	150	25.6	25	S229 - 6	HKV-06-M8x1x20	HAL-04

HRN Compatible With



 Takım Kodu Ordering Code Bestell-Bezeichnung	Takım Ölçüleri (mm) Dimension (mm) Abmessung (mm)					Kesici Uç Insert Wendeschnei-Platte	Sıkma Vidası Screw Schraube	Anahtar Allen Key Torx Schlüssel
	HF=H	B	LF	WF	CDX			
HDKT-HK-R/L-1616-2-T15	16	16	125	16.3	15	S224 - 2	HPV-02-M6*22	HAL-03
HDKT-HK-R/L-2020-2-T15	20	20	125	20.3	15			
HDKT-HK-R/L-2525-2-T15	25	25	150	25.3	15	S224 - 3	HKV-06-M8x1x20	HAL-04
HDKT-HK-R/L-1616-3-T15	16	16	125	16.3	15			
HDKT-HK-R/L-2020-3-T20	20	20	125	20.4	20	S224 - 4	HKV-06-M8x1x20	HAL-04
HDKT-HK-R/L-2525-3-T22	25	25	150	25.4	22			
HDKT-HK-R/L-2020-4-T20	20	20	125	20.4	20	S224 - 4	HKV-06-M8x1x20	HAL-04
HDKT-HK-R/L-2525-4-T22	25	25	150	25.4	22			

HRN Compatible With

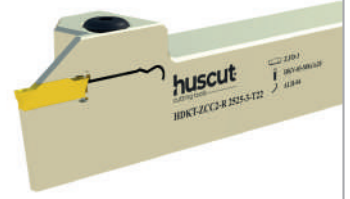
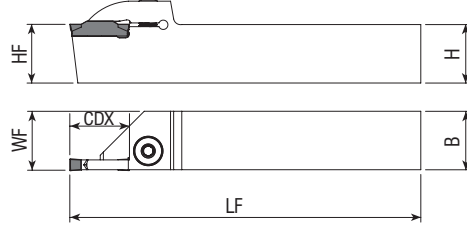
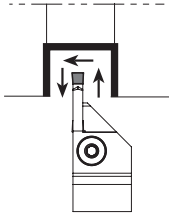

 Takım Kodu Ordering Code Bestell-Bezeichnung	Takım Ölçüleri (mm) Dimension (mm) Abmessung (mm)					Kesici Uç Insert Wendeschnei Platte	Sıkma Vidası Screw Schraube	Anahtar Allen Key Torx Schlüssel
	HF=H	B	LF	WF	CDX			
HDKT-ZCC2-R/L-1616-2-T15	16	16	125	16.2	15	ZBD - 2	HPV-02-M6*22	HAL-03
HDKT-ZCC2-R/L-2020-2-T15	20	20	125	20.2	15			
HDKT-ZCC2-R/L-2525-2-T15	25	25	150	25.2	15			
HDKT-ZCC2-R/L-1616-2.5-T15	16	16	125	16.3	15	ZED - 2.5	HKV-06-M8x1x20	HAL-04
HDKT-ZCC2-R/L-2020-2.5-T15	20	20	125	20.3	15			
HDKT-ZCC2-R/L-2525-2.5-T15	25	25	150	25.3	15			
HDKT-ZCC2-R/L-1616-3-T15	16	16	125	16.3	15	ZFD - 3	HKV-06-M8x1x20	HAL-04
HDKT-ZCC2-R/L-2020-3-T20	20	20	125	20.3	20			
HDKT-ZCC2-R/L-2525-3-T22	25	25	150	25.3	22			
HDKT-ZCC2-R/L-2020-4-T20	20	20	125	20.5	20	ZGD - 4	HKV-06-M8x1x20	HAL-04
HDKT-ZCC2-R/L-2525-4-T22	25	25	150	25.5	22			
HDKT-ZCC2-R/L-2020-5-T20	20	20	125	20.5	20	ZHD - 5	HKV-06-M8x1x20	HAL-04
HDKT-ZCC2-R/L-2525-5-T25	25	25	150	25.5	25			
HDKT-ZCC2-R/L-3232-5-T25	32	32	170	32.5	25	ZKD - 6	HKV-06-M8x1x20	HAL-04
HDKT-ZCC2-R/L-2525-6-T25	25	25	150	25.6	25			
HDKT-ZCC2-R/L-3232-6-T25	32	32	170	32.6	25			

ZCC Compatible With

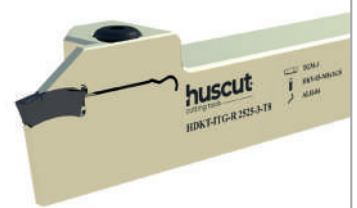
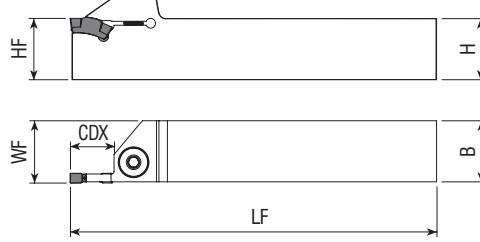
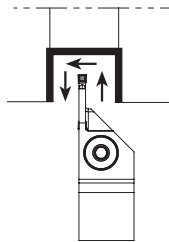



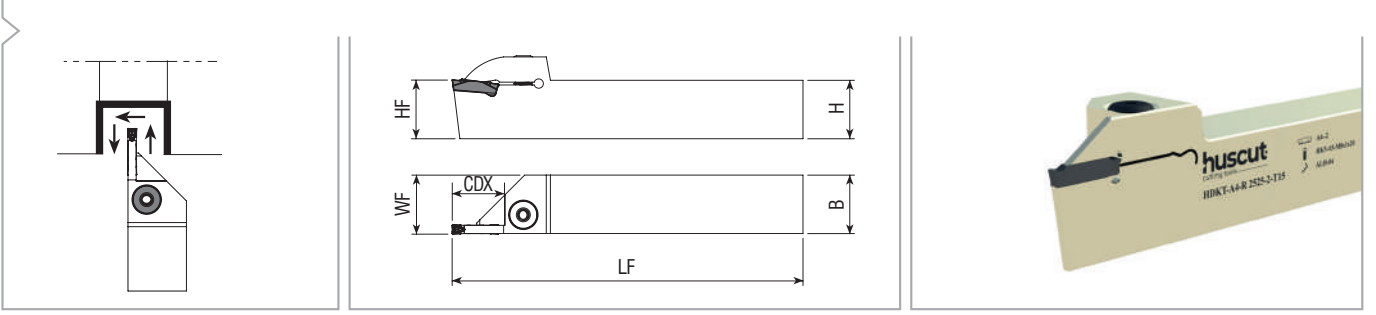

 Takım Kodu Ordering Code Bestell-Bezeichnung	Takım Ölçüleri (mm) Dimension (mm) Abmessung (mm)					Kesici Uç Insert Wendeschnei Platte	Sıkma Vidası Screw Schraube	Anahtar Allen Key Torx Schlüssel
	HF=H	B	LF	WF	CDX			
HDKT-ITG-R/L-2020-3-T8	20	20	125	20.3	8	TGM. - 3	HKV-06-M8x1x20	HAL-04
HDKT-ITG-R/L-2525-3-T8	25	25	150	25.3	8			
HDKT-ITG-R/L-3232-3-T8	32	32	170	32.3	8			
HDKT-ITG-R/L-2020-4-T10	20	20	125	20.4	10	TGM. - 4	HKV-06-M8x1x20	HAL-04
HDKT-ITG-R/L-2525-4-T17	25	25	150	25.4	17			
HDKT-ITG-R/L-3232-4-T17	32	32	170	32.4	17			
HDKT-ITG-R/L-2525-5-T22	25	25	150	25.5	22	TGM. - 5	HKV-06-M8x1x20	HAL-04
HDKT-ITG-R/L-3232-5-T25	32	32	170	32.5	25			

ISCR Compatible With





 Takım Kodu Ordering Code Bestell-Bezeichnung	Takım Ölçüleri (mm) Dimension (mm) Abmessung (mm)					Kesici Uç Insert Wendeschnei Platte	Sıkma Vidası Screw Schraube	Anahtar Allen Key Torx Schlüssel
	HF=H	B	LF	WF	CDX			
HDKT-KM-R/L-2020-2-T15	20	20	125	20.3	15	A4 - 2	HPV-02-M6*22	HAL-03
HDKT-KM-R/L-2525-2-T15	25	25	150	25.3	15	A4 - 3	HKV-06-M8x1x20	HAL-04
HDKT-KM-R/L-2020-3-T20	20	20	125	20.4	20	A4 - 3	HKV-06-M8x1x20	HAL-04
HDKT-KM-R/L-2525-3-T22	25	25	150	25.4	22	A4 - 4	HKV-06-M8x1x20	HAL-04
HDKT-KM-R/L-2020-4-T20	20	20	125	20.4	20	A4 - 4	HKV-06-M8x1x20	HAL-04
HDKT-KM-R/L-2525-4-T22	25	25	150	25.4	22	A4 - 4	HKV-06-M8x1x20	HAL-04

KNMTL Compatible With

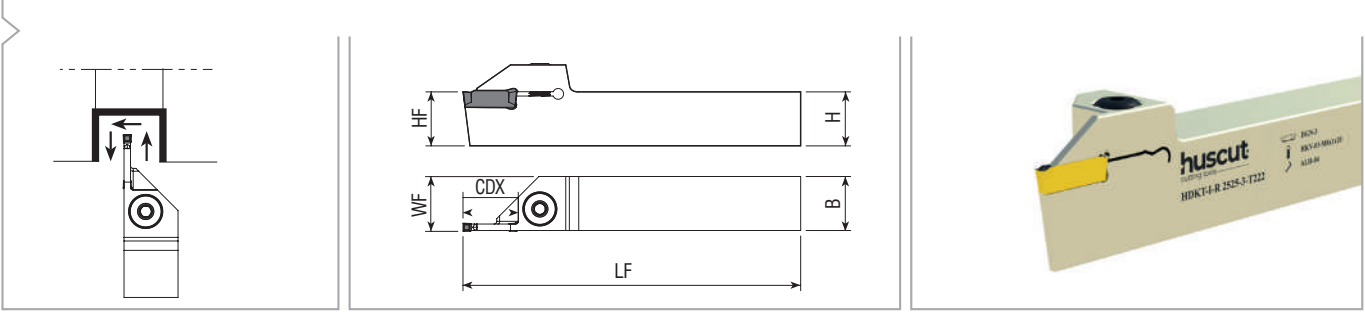



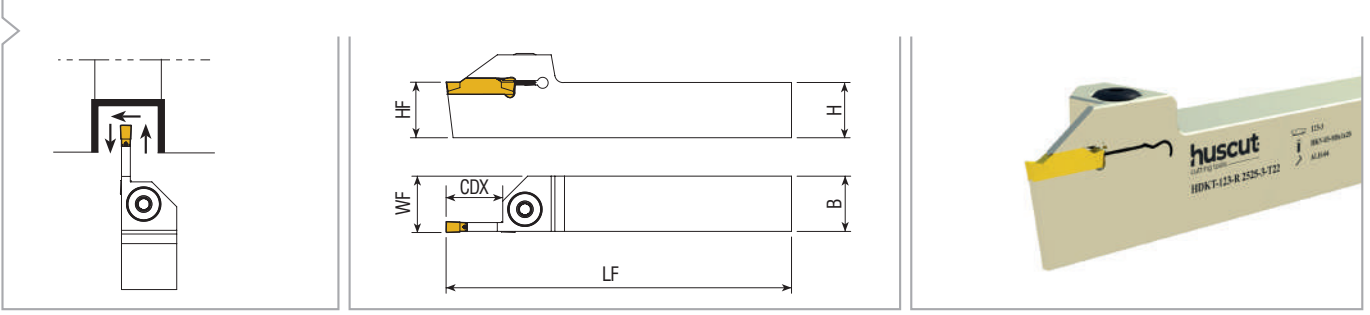

 Takım Kodu Ordering Code Bestell-Bezeichnung	Takım Ölçüleri (mm) Dimension (mm) Abmessung (mm)					Kesici Uç Insert Wendeschnei-Platte	Sıkma Vidası Screw Schraube	Anahtar Allen Key Torx Schlüssel
	HF=H	B	LF	WF	CDX			
HDKT-I-R/L-1212-2-T15	12	12	125	16.3	15	DGN - 2	HPV-02-M6*22	HAL-03
HDKT-I-R/L-1616-2-T15	16	16	100	16.3	15			
HDKT-I-R/L-2020-2-T15	20	20	125	20.3	15			
HDKT-I-R/L-2525-2-T15	25	25	150	25.3	15			
HDKT-I-R/L-3232-2-T15	32	32	170	32.3	15			
HDKT-I-R/L-1212-3-T15	12	12	100	16.3	15	DGN - 3		
HDKT-I-R/L-1616-3-T15	16	16	125	16.3	15			
HDKT-I-R/L-2020-3-T20	20	20	125	20.3	20			
HDKT-I-R/L-2525-3-T22	25	25	150	25.3	22			
HDKT-I-R/L-2525-3-T25	25	25	150	25.3	25			
HDKT-I-R/L-2525-3-T40	25	25	150	25.3	40	DGN / GRP - 4	HKV-06-M8x1x20	HAL-03
HDKT-I-R/L-3232-3-T22	32	32	170	32.3	22			
HDKT-I-R/L-2020-4-T20	20	20	125	20.4	20			
HDKT-I-R/L-2525-4-T22	25	25	150	25.4	22			
HDKT-I-R/L-2525-4-T25	25	25	150	25.4	25			
HDKT-I-R/L-2525-4-T40	25	25	150	25.4	40	DGN / GRP - 5		
HDKT-I-R/L-3232-4-T25	32	32	170	32.4	25			
HDKT-I-R/L-2020-5-T20	20	20	125	20.5	20			
HDKT-I-R/L-2525-5-T25	25	25	150	25.5	25	GRP - 3		
HDKT-I-R/L-3232-5-T25	32	32	170	32.5	25			
HDKT-IG-R/L-1212-3-T15	12	12	100	12.3	15			
HDKT-IG-R/L-1616-3-T15	16	16	125	16.3	15			
HDKT-IG-R/L-2020-3-T20	20	20	125	20.3	20			
HDKT-IG-R/L-2525-3-T22	25	25	150	25.3	22			

ISCR Comptip® WH







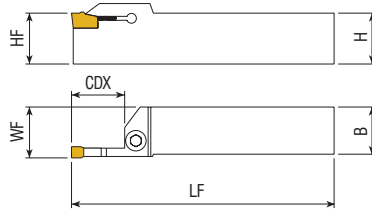
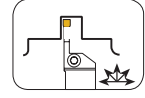

 Takım Kodu Ordering Code Bestell-Bezeichnung	Takım Ölçüleri (mm) Dimension (mm) Abmessung (mm)					Kesici Uç Insert Wendeschnei-Platte	Sıkma Vidası Screw Schraube	Anahtar Allen Key Torx Schlüssel
	HF=H	B	LF	WF	CDX			
HDKT-123-R/L-1616-2-T15	16	16	125	16.2	15	123-2	HPV-02-M6*22	HAL-03
HDKT-123-R/L-2020-2-T15	20	20	125	20.2	15			
HDKT-123-R/L-2525-2-T15	25	25	150	25.2	15			
HDKT-123-R/L-3232-2-T15	32	32	170	32.2	15	123-3		
HDKT-123-R/L-1616-3-T15	16	16	125	16.3	15			
HDKT-123-R/L-2020-3-T10	20	20	125	20.3	10			
HDKT-123-R/L-2020-3-T20	20	20	125	20.3	20			
HDKT-123-R/L-2525-3-T15	25	25	150	25.3	15			
HDKT-123-R/L-2525-3-T22	25	25	150	25.3	22			
HDKT-123-R/L-2525-3-T25	25	25	150	25.3	25	123-4	HKV-06-M8x1x20	HAL-4
HDKT-123-R/L-2525-3-T40	25	25	150	25.3	40			
HDKT-123-R/L-2020-4-T20	20	20	125	20.4	20			
HDKT-123-R/L-2525-4-T22	25	25	150	25.4	22			
HDKT-123-R/L-2525-4-T25	25	25	150	25.4	25	123-5		
HDKT-123-R/L-2525-4-T40	25	25	150	25.4	40			
HDKT-123-R/L-3232-4-T25	32	32	170	32.4	25	123-6		
HDKT-123-R/L-2020-5-T20	20	20	125	20.5	20			
HDKT-123-R/L-2525-5-T25	25	25	150	25.5	25			
HDKT-123-R/L-3232-5-T25	32	32	170	32.5	25	123-6		
HDKT-123-R/L-2525-6-T25	25	25	150	25.5	25			
HDKT-123-R/L-3232-6-T25	32	32	170	32.5	25			

SNV/K Compatible With



 Takım Kodu Ordering Code Bestell-Bezeichnung	Takım Ölçüleri (mm) Dimension (mm) Abmessung (mm)					Kesici Uç Insert Wendeschnei Platte	Sıkma Vidası Screw Schraube	Anahtar Allen Key Torx Schlüssel
	HF=H	B	LF	WF	CDX			
HDKT-151.2-R/L-1616-2-T15	16	16	125	16.3	15	1512-2	HPV-02-M6*22	HAL-03
HDKT-151.2-R/L-2020-2-T15	20	20	125	20.3	15			
HDKT-151.2-R/L-2525-2-T15	25	25	150	25.3	15			
HDKT-151.2-R/L-1616-3-T15	16	16	125	16.4	15	1512-3	HKV-06-M8x1x20	HAL-04
HDKT-151.2-R/L-2020-3-T20	20	20	125	20.4	20			
HDKT-151.2-R/L-2525-3-T22	25	25	150	25.4	22			
HDKT-151.2-R/L-1616-4-T15	16	16	125	16.4	15	1512-4	HKV-06-M8x1x20	HAL-04
HDKT-151.2-R/L-2020-4-T20	20	20	125	20.4	20			
HDKT-151.2-R/L-2525-4-T22	25	25	150	25.4	22			
HDKT-151.2-R/L-2020-5-T20	20	20	125	20.4	20	1512-5	HKV-06-M8x1x20	HAL-04
HDKT-151.2-R/L-2525-5-T25	25	25	150	25.5	25			

SNDV/K Compatible With



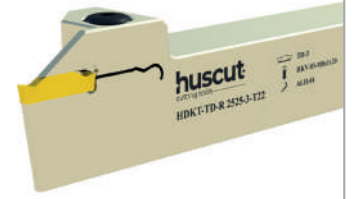
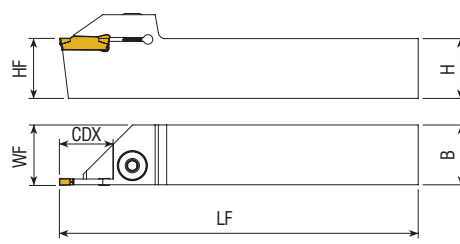
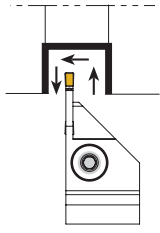



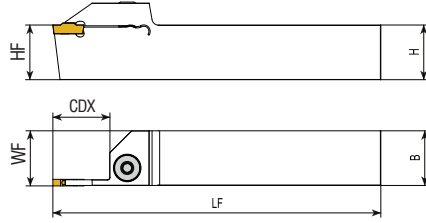
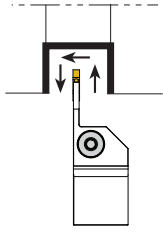

 Takım Kodu Ordering Code Bestell-Bezeichnung	Takım Ölçüleri (mm) Dimension (mm) Abmessung (mm)					Kesici Uç Insert Wendeschnei-Platte	Sıkma Vidası Screw Schraube	Anahtar Allen Key Torx Schlüssel
	HF=H	B	LF	WF	CDX			
HDKT-TD-R/L-1212-2-T15	12	12	100	12.2	15	TD.-2	HPV-02-M6*22	HAL-03
HDKT-TD-R/L-1616-2-T15	16	16	125	16.2	15			
HDKT-TD-R/L-2020-2-T15	20	20	125	20.2	15			
HDKT-TD-R/L-2525-2-T17	25	25	150	25.2	17			
HDKT-TD-R/L-1212-3-T15	12	12	100	12.4	15	TD.-3	HKV-06-M8x1x20	HAL-04
HDKT-TD-R/L-1616-3-T15	16	16	125	16.4	15			
HDKT-TD-R/L-2020-3-T20	20	20	125	20.4	20			
HDKT-TD-R/L-2525-3-T15	25	25	150	25.4	15			
HDKT-TD-R/L-2525-3-T22	25	25	150	25.4	22			
HDKT-TD-R/L-2525-3-T25	25	25	150	25.4	25			
HDKT-TD-R/L-3232-3-T22	32	32	170	32.4	22	TD.-4	HKV-06-M8x1x20	HAL-04
HDKT-TD-R/L-3232-3-T25	32	32	170	32.4	25			
HDKT-TD-R/L-2020-4-T20	20	20	125	20.4	20			
HDKT-TD-R/L-2525-4-T15	25	25	150	25.4	15			
HDKT-TD-R/L-2525-4-T22	25	25	150	25.4	22	TD.-5	HKV-06-M8x1x20	HAL-04
HDKT-TD-R/L-2525-4-T25	25	25	150	25.4	25			
HDKT-TD-R/L-3232-4-T22	32	32	170	32.4	22			
HDKT-TD-R/L-2525-5-T25	25	25	150	25.5	25	TD.-5	HKV-06-M8x1x20	HAL-04
HDKT-TD-R/L-3232-5-T25	32	32	170	32.5	25			

TGT Compatible With







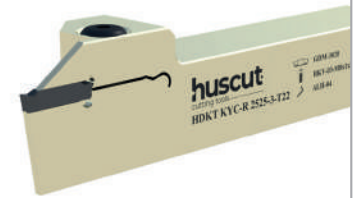
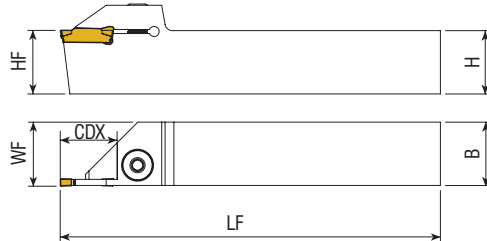
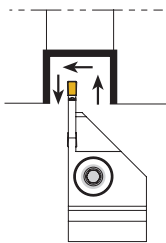

 Takım Kodu Ordering Code Bestell-Bezeichnung	Takım Ölçüleri (mm) Dimension (mm) Abmessung (mm)					Kesici Uç Insert Wendeschnei Platte	Sıkma Vidası Screw Schraube	Anahtar Allen Key Torx Schlüssel
	HF=H	B	LF	WF	CDX			
HDKT-RD-R/L-1616-2-T17	16	16	125	16.2	17	RD.-2	HPV-02-M6*22	HAL-03
HDKT-RD-R/L-2020-2-T17	20	20	125	20.2	17			
HDKT-RD-R/L-2525-2-T17	25	25	150	25.2	17			
HDKT-RD-R/L-1616-3-T15	16	16	125	16.3	15	RD.-3	HKV-06-M8x1x20	HAL-04
HDKT-RD-R/L-2020-3-T20	20	20	125	20.3	20			
HDKT-RD-R/L-2525-3-T22	25	25	150	25.3	22			
HDKT-RD-R/L-1616-4-T15	16	16	125	16.4	15	RD.-4	HKV-06-M8x1x20	HAL-04
HDKT-RD-R/L-2020-4-T20	20	20	125	20.4	20			
HDKT-RD-R/L-2525-4-T22	25	25	150	25.4	22			

TIGC Compatible With









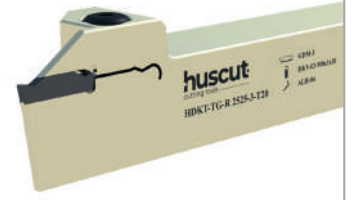
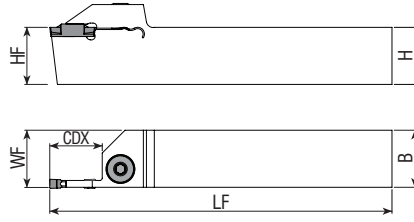
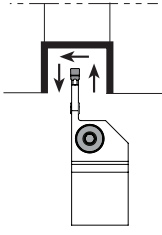





 Takım Kodu Ordering Code Bestell-Bezeichnung	Takım Ölçüleri (mm) Dimension (mm) Abmessung (mm)					Kesici Uç Insert Wendeschnei Platte	Sıkma Vidası Screw Schraube	Anahtar Allen Key Torx Schlüssel
	HF=H	B	LF	WF	CDX			
HDKT-KYC-R/L-2020-2-T15	20	20	125	20.2	15	GDM 2020	HPV-02-M6*22	HAL-03
HDKT-KYC-R/L-2525-2-T15	25	25	150	25.2	15			
HDKT-KYC-R/L-2020-3-T20	20	20	125	20.3	20	GDM 3020	HKV-06-M8x1x20	HAL-04
HDKT-KYC-R/L-2525-3-T22	25	25	150	25.3	22			
HDKT-KYC-R/L-2020-4-T20	20	20	125	20.4	20	GDM 4020	HKV-06-M8x1x20	HAL-04
HDKT-KYC-R/L-2525-4-T22	25	25	150	25.4	22			

KYCR Compatible With

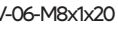

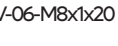





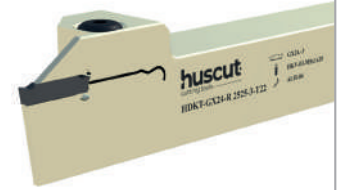
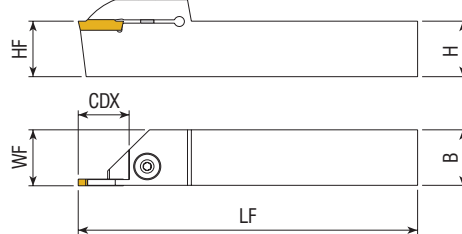
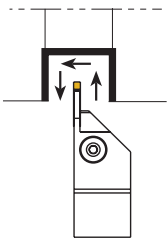









 Takım Kodu Ordering Code Bestell-Bezeichnung	Takım Ölçüleri (mm) Dimension (mm) Abmessung (mm)					Kesici Uç Insert Wendeschnei Platte	Sıkma Vidası Screw Schraube	Anahtar Allen Key Torx Schlüssel
	HF=H	B	LF	WF	CDX			
HDKT-TG-R/L-1616-2-T15	16	16	125	16.2	15			
HDKT-TG-R/L-2020-2-T15	20	20	125	20.2	15			
HDKT-TG-R/L-2525-2-T15	25	25	150	25.2	15			
HDKT-TG-R/L-1616-3-T15	16	16	125	16.3	15			
HDKT-TG-R/L-2020-3-T20	20	20	125	20.3	20			
HDKT-TG-R/L-2525-3-T22	25	25	150	25.3	22			
HDKT-TG-R/L-2020-4-T20	20	20	125	20.5	20			
HDKT-TG-R/L-2525-4-T22	25	25	150	25.5	22			
HDKT-TG-R/L-2525-5-T25	25	25	150	25.5	25			

W/LTR Compatible With

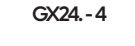





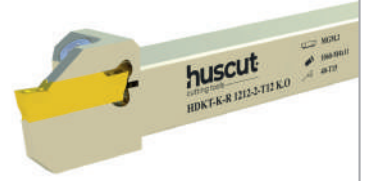
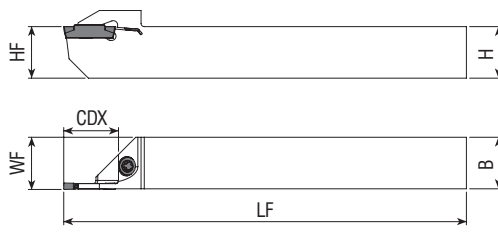
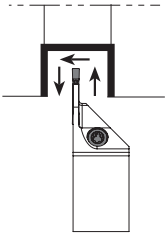

 Takım Kodu Ordering Code Bestell-Bezeichnung	Takım Ölçüleri (mm) Dimension (mm) Abmessung (mm)					Kesici Uç Insert Wendeschnei Platte	Sıkma Vidası Screw Schraube	Anahtar Allen Key Torx Schlüssel
	HF=H	B	LF	WF	CDX			
HDKT-GX16-R/L-2020-2-T15	20	20	125	20.2	15			
HDKT-GX16-R/L-2525-2-T15	25	25	150	25.2	15			
HDKT-GX16-R/L-2020-3-T20	20	20	125	20.2	20			
HDKT-GX16-R/L-2525-3-T22	25	25	150	25.2	22			
HDKT-GX24-R/L-2020-3-T20	20	20	125	20.4	20			
HDKT-GX24-R/L-2525-3-T22	25	25	150	25.4	22			
HDKT-GX24-R/L-3232-3-T22	32	32	170	32.4	22			
HDKT-GX24-R/L-2020-4-T20	20	20	125	20.5	20			
HDKT-GX24-R/L-2525-4-T22	25	25	150	25.5	22			
HDKT-GX24-R/L-3232-4-T22	32	32	170	32.5	22			
HDKT-GX24-R/L-2525-5-T25	25	25	150	25.5	25			
HDKT-GX24-R/L-3232-5-T25	32	32	170	32.5	25			

W/LTR Compatible With









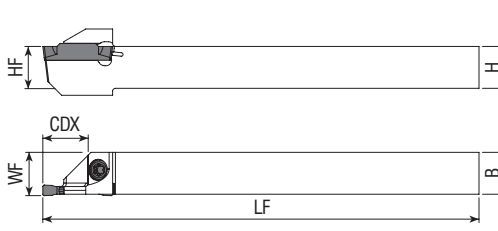
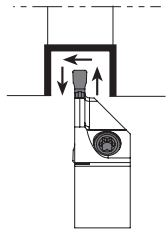

 Takım Kodu Ordering Code Bestell-Bezeichnung	Takım Ölçüleri (mm) Dimension (mm) Abmessung (mm)					Kesici Uç Insert Wendeschnei Platte	Sıkma Vidası Screw Schraube	Tork Anahtar Torx Key Torx Schlüssel
	HF=H	B	LF	WF	CDX			
HDKT-K-R/L-1010-2-T10-K-O	10	10	100	10.2	10		1060-M4x11	HTA-T15
HDKT-K-R/L-1212-2-T12-K-O	12	12	125	12.2	12			
HDKT-K-R/L-1616-2-T16-K-O	16	16	125	16.2	16			
HDKT-K-R/L-1212-3-T12-K-O	12	12	125	12.3	12		1060-M4x11	HTA-T15
HDKT-K-R/L-1616-3-T16-K-O	16	16	125	16.3	16			

KRLV Compatible With







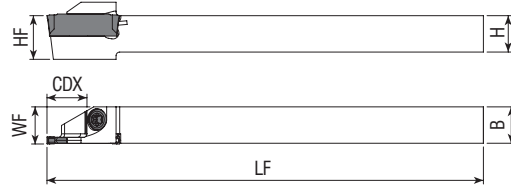
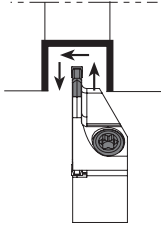

 Takım Kodu Ordering Code Bestell-Bezeichnung	Takım Ölçüleri (mm) Dimension (mm) Abmessung (mm)					Kesici Uç Insert Wendeschnei Platte	Sıkma Vidası Screw Schraube	Tork Anahtar Torx Key Torx Schlüssel
	HF=H	B	LF	WF	CDX			
HDKT-KG-R/L-1010-2-T10-K-O	10	10	100	10.2	10		1060-M4x11	HTA-T15
HDKT-KG-R/L-1212-2-T12-K-O	12	12	125	12.2	12			
HDKT-KG-R/L-1616-2-T16-K-O	16	16	125	16.2	16			
HDKT-KG-R/L-1212-3-T12-K-O	12	12	125	12.3	12		1060-M4x11	HTA-T15
HDKT-KG-R/L-1616-3-T16-K-O	16	16	125	16.3	16			

KRLV Compatible With









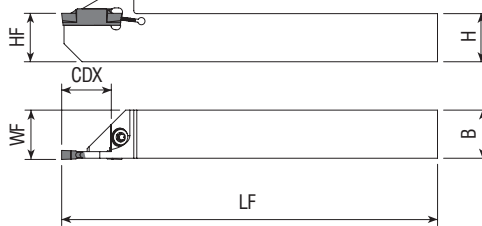
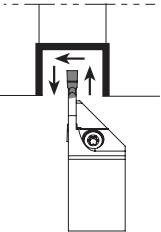

 Takım Kodu Ordering Code Bestell-Bezeichnung	Takım Ölçüleri (mm) Dimension (mm) Abmessung (mm)					Kesici Uç Insert Wendeschnei-Platte	Sıkma Vidası Screw Schraube	Tork Anahtar Torx Key Torx Schlüssel
	HF=H	B	LF	WF	CDX			
HDKT-I-R/L-1010-2-T10-K-O	10	10	125	10.2	10	 DGN-2	 1060-M4x11	 HTA-T15
HDKT-I-R/L-1212-2-T12-K-O	12	12	125	12.2	12			
HDKT-I-R/L-1616-2-T16-K-O	16	16	125	16.2	16			
HDKT-I-R/L-1010-3-T10-K-O	10	10	125	10.3	10	 DGN-3	 1060-M4x11	 HTA-T15
HDKT-I-R/L-1212-3-T12-K-O	12	12	125	12.3	12			
HDKT-I-R/L-1616-3-T16-K-O	16	16	125	16.3	16			





ISCR Compatible With

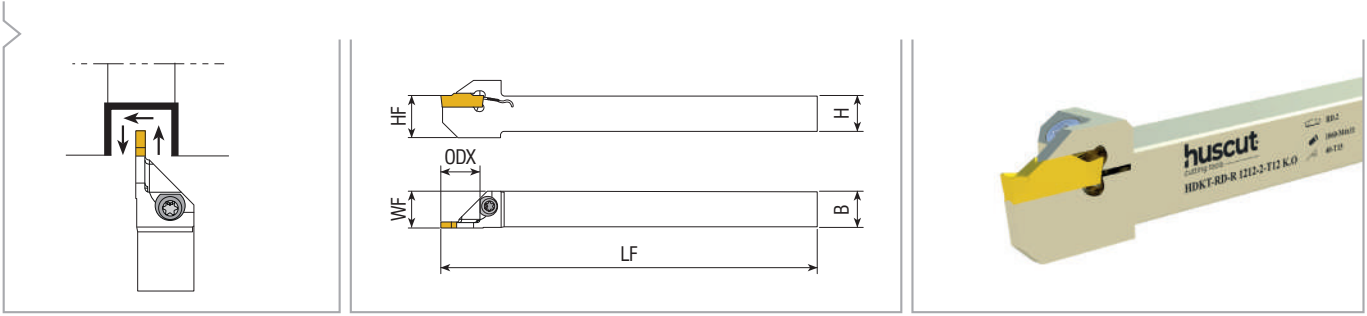

 Takım Kodu Ordering Code Bestell-Bezeichnung	Takım Ölçüleri (mm) Dimension (mm) Abmessung (mm)					Kesici Uç Insert Wendeschnei-Platte	Sıkma Vidası Screw Schraube	Tork Anahtar Torx Key Torx Schlüssel
	HF=H	B	LF	WF	CDX			
HDKT-ZCC2-R/L-1010-2-T12-K-O	10	10	125	10.2	12	 ZBD-2	 1060-M4x11	 HTA-T15
HDKT-ZCC2-R/L-1212-2-T12-K-O	12	12	125	12.2	12			
HDKT-ZCC2-R/L-1616-2-T16-K-O	16	16	125	16.2	16			
HDKT-ZCC2-R/L-1212-3-T12-K-O	12	12	125	12.3	12	 ZFD-3	 1060-M4x11	 HTA-T15
HDKT-ZCC2-R/L-1616-3-T16-K-O	16	16	125	16.3	16			





ZCC Compatible With

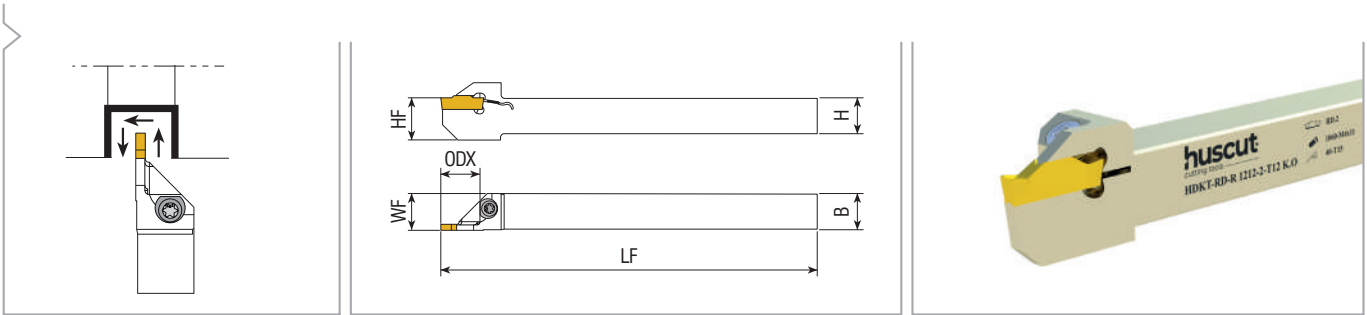

 Takım Kodu Ordering Code Bestell-Bezeichnung	Takım Ölçüleri (mm) Dimension (mm) Abmessung (mm)					Kesici Uç Insert Wendeschnei-Platte	Sıkma Vidası Screw Schraube	Tork Anahtar Torx Key Torx Schlüssel
	HF=H	B	LF	WF	CDX			
HDKT-RD-R/L-1212-2-T12-K-O	12	12	125	12.2	12	RD-2	1060-M4x11	HTA-T15
HDKT-RD-R/L-1616-2-T16-K-O	16	16	125	16.2	16			
HDKT-RD-R/L-1212-3-T12-K-O	12	12	125	12.3	12	RD-3	1060-M4x11	HTA-T15
HDKT-RD-R/L-1616-3-T16-K-O	16	16	125	16.3	16			





TCTC Compatible With

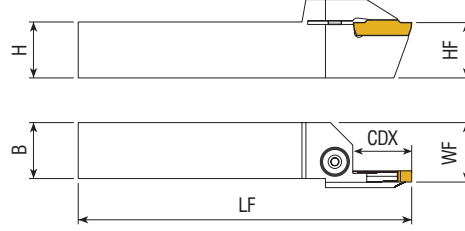
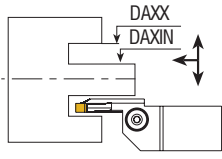

 Takım Kodu Ordering Code Bestell-Bezeichnung	Takım Ölçüleri (mm) Dimension (mm) Abmessung (mm)					Kesici Uç Insert Wendeschnei-Platte	Sıkma Vidası Screw Schraube	Tork Anahtar Torx Key Torx Schlüssel
	HF=H	B	LF	WF	CDX			
HDKT-TD-R/L-1010-2-T10-K-O	10	10	125	10.2	12	TD-2	1060-M4x11	HTA-T15
HDKT-TD-R/L-1212-2-T12-K-O	12	12	125	12.2	12			
HDKT-TD-R/L-1616-2-T16-K-O	16	16	125	16.2	16	TD-3	1060-M4x11	HTA-T15
HDKT-TD-R/L-1212-3-T12-K-O	12	12	125	12.3	12			
HDKT-TD-R/L-1616-3-T16-K-O	16	16	125	16.3	16			

TCTC Compatible With





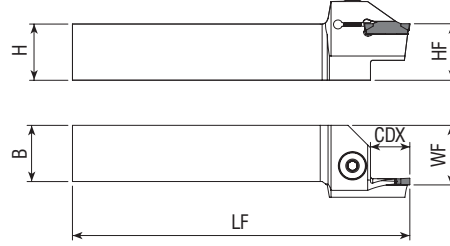
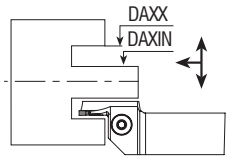

 Takım Kodu Ordering Code Bestell-Bezeichnung	Takım Ölçüleri (mm) Dimension (mm) Abmessung (mm)							Kesici Uç Insert Wendeschnei-Platte	Sıkma Vidası Screw Schraube	Anahtar Allen Key Torx Schlüssel			
	HF=H	B	LF	WF	CDX	DAXIN	DAXX						
HAKT-K-R/L-2525-24-36-3-T17	25	25	150	26.5	17	24	36	MGM. - 3					
HAKT-K-R/L-2525-34-45-3-T17	25	25	150	26.5	17	34	45						
HAKT-K-R/L-2525-39-55-3-T17	25	25	150	26.5	17	39	55						
HAKT-K-R/L-2525-49-80-3-T17	25	25	150	26.5	17	49	80						
HAKT-K-R/L-2525-70-110-3-T17	25	25	150	26.5	17	70	110						
HAKT-K-R/L-2525-100-150-3-T17	25	25	150	26.5	17	100	150						
HAKT-K-R/L-2525-80-180-3-T32	25	25	150	26.5	32	80	180						
HAKT-K-R/L-2525-175-215-3-T22	25	25	150	26.5	22	175	215						
HAKT-K-R/L-2525-215-350-3-T22	25	25	150	26.5	22	215	350						
HAKT-K-R/L-2525-300-500-3-T22	25	25	150	26.5	22	300	500						
HAKT-K-R/L-2525-24-36-4-T22	25	25	150	26.5	22	24	36	MGM. - 4	HKV-06-M8x1x20	HAL-04			
HAKT-K-R/L-2525-36-50-4-T22	25	25	150	26.5	22	36	50						
HAKT-K-R/L-2525-50-85-4-T22	25	25	150	26.5	22	50	85						
HAKT-K-R/L-2525-70-110-4-T22	25	25	150	26.5	22	70	110						
HAKT-K-R/L-2525-100-150-4-T22	25	25	150	26.5	22	100	150						
HAKT-K-R/L-2525-80-180-4-T32	25	25	150	26.5	32	80	180						
HAKT-K-R/L-2525-180-800-4-T32	25	25	150	26.5	32	180	800						
HAKT-K-R/L-2525-36-50-5-T25	25	25	150	26.5	25	36	50						
HAKT-K-R/L-2525-50-70-5-T25	25	25	150	26.5	25	50	70						
HAKT-K-R/L-2525-70-110-5-T25	25	25	150	26.5	25	70	110						
HAKT-K-R/L-2525-100-150-5-T25	25	25	150	26.5	25	100	150	MGM. - 5					
HAKT-K-R/L-2525-80-180-5-T32	25	25	150	26.5	32	80	180						
HAKT-K-R/L-2525-140-200-5-T25	25	25	150	26.5	25	140	200						
HAKT-K-R/L-2525-180-800-5-T32	25	25	150	26.5	32	180	800						
HAKT-K-R/L-2525-60-100-6-T25	25	25	150	26.5	25	60	100				MGM. - 6		
HAKT-K-R/L-2525-60-100-6-T35	25	25	150	26.5	35	60	100						
HAKT-K-R/L-2525-100-200-6-T25	25	25	150	26.5	25	100	200						
HAKT-K-R/L-2525-100-200-6-T35	25	25	150	26.5	35	100	200						
HAKT-K-R/L-2525-100-200-6-T45	25	25	150	26.5	45	100	200						
HAKT-K-R/L-2525-140-300-6-T35	25	25	150	26.5	35	140	300						

KRLR Compatible With







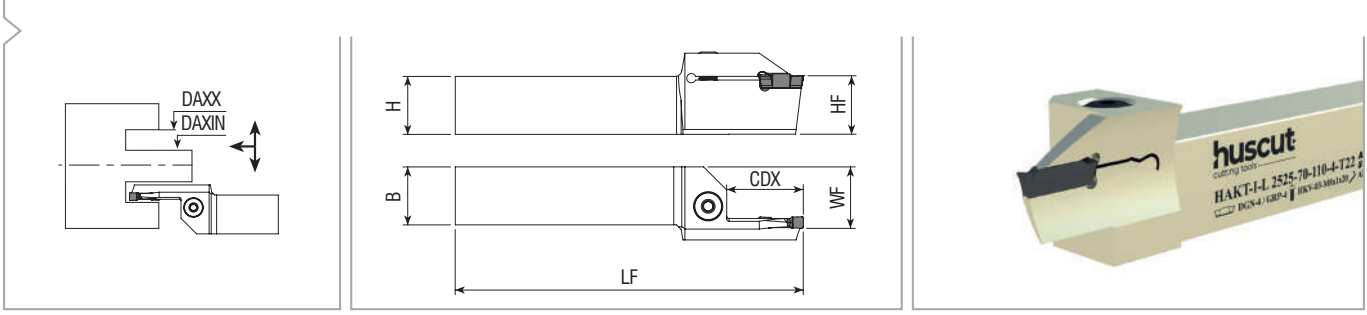

 Takım Kodu Ordering Code Bestell-Bezeichnung	Takım Ölçüleri (mm) Dimension (mm) Abmessung (mm)							Kesici Uç Inset Wendeschnei-Platte	Sıkma Vidası Screw Schraube	Anahtar Allen Key Torx Schlüssel			
	HF=H	B	LF	WF	CDX	DAXIN	DAXX						
HAKT-ZCC2-R/L-2525-24-36-3-T17	25	25	150	26.5	17	24	36	ZFD-3					
HAKT-ZCC2-R/L-2525-35-45-3-T17	25	25	150	26.5	17	35	45						
HAKT-ZCC2-R/L-2525-39-55-3-T17	25	25	150	26.5	17	39	55						
HAKT-ZCC2-R/L-2525-49-80-3-T17	25	25	150	26.5	17	49	80						
HAKT-ZCC2-R/L-2525-70-110-3-T17	25	25	150	26.5	17	70	110						
HAKT-ZCC2-R/L-2525-100-150-3-T17	25	25	150	26.5	17	100	150						
HAKT-ZCC2-R/L-2525-150-200-3-T17	25	25	150	26.5	17	150	200						
HAKT-ZCC2-R/L-2525-200-350-3-T17	25	25	150	26.5	17	200	350						
HAKT-ZCC2-R/L-2525-300-500-3-T17	25	25	150	26.5	17	300	500						
HAKT-ZCC2-R/L-2525-36-48-4-T22	25	25	150	26.5	22	36	48				ZGD-4	HKV-06-M8x1x20	HAL-04
HAKT-ZCC2-R/L-2525-40-60-4-T22	25	25	150	26.5	22	40	60						
HAKT-ZCC2-R/L-2525-52-80-4-T22	25	25	150	26.5	22	52	80						
HAKT-ZCC2-R/L-2525-72-110-4-T22	25	25	150	26.5	22	72	110						
HAKT-ZCC2-R/L-2525-100-150-4-T22	25	25	150	26.5	22	100	150						
HAKT-ZCC2-R/L-2525-140-200-4-T22	25	25	150	26.5	22	140	200						
HAKT-ZCC2-R/L-2525-200-350-4-T22	25	25	150	26.5	22	200	350						
HAKT-ZCC2-R/L-2525-300-500-4-T22	25	25	150	26.5	22	300	500						
HAKT-ZCC2-R/L-2525-55-95-5-T25	25	25	150	26.5	25	55	95	ZHD-5					
HAKT-ZCC2-R/L-2525-85-140-5-T25	25	25	150	26.5	25	85	140						
HAKT-ZCC2-R/L-2525-130-200-5-T25	25	25	150	26.5	25	130	200						
HAKT-ZCC2-R/L-2525-190-400-5-T25	25	25	150	26.5	25	190	400						
HAKT-ZCC2-R/L-2525-200-500-5-T25	25	25	150	26.5	25	200	500						

ZCC Compatible With









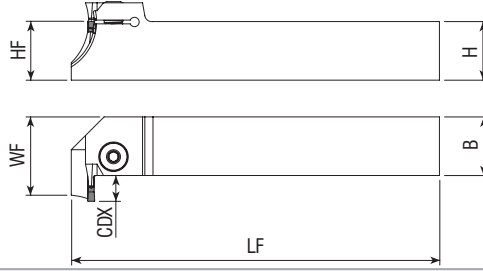
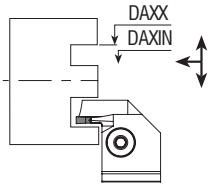

 Takım Kodu Ordering Code Bestell-Bezeichnung	Takım Ölçüleri (mm) Dimension (mm) Abmessung (mm)							Kesici Uç Insert Wendeschnelplatte	Sıkma Vidası Screw Schraube	Anahtar Allen Key Torx Schlüssel
	HF=H	B	LF	WF	CDX	DAXIN	DAXX			
HAKT-IG-R/L-2525-24-42-4-T22	25	25	150	26.5	22	24	42	DGN / GRP - 4	HKV-06-M8x1x20	HAL-04
HAKT-IG-R/L-2525-40-60-4-T22	25	25	150	26.5	22	40	60			
HAKT-IG-R/L-2525-52-80-4-T22	25	25	150	26.5	22	52	80			
HAKT-IG-R/L-2525-70-110-4-T22	25	25	150	26.5	22	70	110			
HAKT-IG-R/L-2525-100-150-4-T22	25	25	150	26.5	22	100	150			
HAKT-IG-R/L-2525-110-200-4-T22	25	25	150	26.5	22	110	200			
HAKT-IG-R/L-2525-140-200-4-T22	25	25	150	26.5	22	140	200			
HAKT-IG-R/L-2525-180-800-4-T22	25	25	150	26.5	22	180	800			
HAKT-IG-R/L-2525-200-800-4-T22	25	25	150	26.5	22	200	800			
HAKT-IG-R/L-2525-70-110-5-T25	25	25	150	26.5	25	70	110	DGN / GRP - 5		
HAKT-IG-R/L-2525-110-200-5-T25	25	25	150	26.5	25	110	200			
HAKT-IG-R/L-2525-180-800-5-T25	25	25	150	26.5	25	180	800			

ISCR Compatible With



 Takım Kodu Ordering Code Bestell-Bezeichnung	Takım Ölçüleri (mm) Dimension (mm) Abmessung (mm)							Kesici Uç Insert Wendeschnei Platte	Sıkma Vidası Screw Schraube	Anahtar Allen Key Torx Schlüssel
	HF=H	B	LF	WF	CDX	DAXIN	DAXX			
HLKT-ZCC2-R/L-2525-24-36-3-T17	25	25	150	43	17	24	36	ZFD-3		
HLKT-ZCC2-R/L-2525-36-56-3-T17	25	25	150	43	17	36	56			
HLKT-ZCC2-R/L-2525-50-70-3-T17	25	25	150	43	17	50	70			
HLKT-ZCC2-R/L-2525-70-110-3-T17	25	25	150	43	17	70	110			
HLKT-ZCC2-R/L-2525-100-150-3-T17	25	25	150	43	17	100	150			
HLKT-ZCC2-R/L-2525-150-200-3-T17	25	25	150	43	17	150	200			
HLKT-ZCC2-R/L-2525-200-350-3-T17	25	25	150	43	17	200	350			
HLKT-ZCC2-R/L-2525-300-500-3-T17	25	25	150	43	17	300	500	HKV-06-M8x1x20	HAL-04	
HLKT-ZCC2-R/L-2525-24-36-4-T20	25	25	150	48	20	24	36			
HLKT-ZCC2-R/L-2525-36-56-4-T20	25	25	150	48	20	36	56			
HLKT-ZCC2-R/L-2525-50-70-T20	25	25	150	48	20	50	70			
HLKT-ZCC2-R/L-2525-70-110-4-T20	25	25	150	48	20	70	110			
HLKT-ZCC2-R/L-2525-100-150-4-T20	25	25	150	48	20	100	150			
HLKT-ZCC2-R/L-2525-150-200-4-T20	25	25	150	48	20	150	200			
HLKT-ZCC2-R/L-2525-200-350-4-T20	25	25	150	48	20	200	350			
HLKT-ZCC2-R/L-2525-300-500-4-T20	25	25	150	48	20	300	500			

ZCC Compatible With



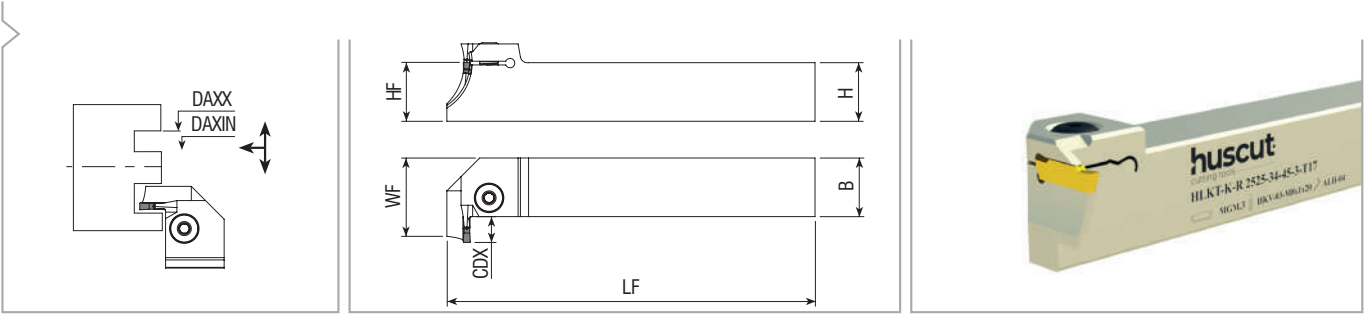

Takım Kodu Ordering Code Bestell-Bezeichnung	Takım Ölçüleri (mm) Dimension (mm) Abmessung (mm)							Kesici Uç Insert Wendeschnei-Platte	Sıkma Vidası Screw Schraube	Anahtar Allen Key Torx Schlüssel
	HF=H	B	LF	WF	CDX	DAXIN	DAXX			
HLKT-K-R/L-2525-24-36-3-T17	25	25	150	43	17	24	36	MGM.-3	HKV-06-M8x1x20	HAL-04
HLKT-K-R/L-2525-36-56-3-T17	25	25	150	43	17	36	56			
HLKT-K-R/L-2525-50-70-3-T17	25	25	150	43	17	50	70			
HLKT-K-R/L-2525-70-110-3-T17	25	25	150	43	17	70	110			
HLKT-K-R/L-2525-100-150-3-T17	25	25	150	43	17	100	150			
HLKT-K-R/L-2525-150-200-3-T17	25	25	150	43	17	150	200			
HLKT-K-R/L-2525-200-350-3-T17	25	25	150	43	17	200	350			
HLKT-K-R/L-2525-300-500-3-T17	25	25	150	43	17	300	500			
HLKT-K-R/L-2525-24-36-4-T20	25	25	150	48	20	24	36	MGM.-4	HKV-06-M8x1x20	HAL-04
HLKT-K-R/L-2525-36-56-4-T20	25	25	150	48	20	36	56			
HLKT-K-R/L-2525-50-70-T20	25	25	150	48	20	50	70			
HLKT-K-R/L-2525-70-110-4-T20	25	25	150	48	20	70	110			
HLKT-K-R/L-2525-100-150-4-T20	25	25	150	48	20	100	150			
HLKT-K-R/L-2525-150-200-4-T20	25	25	150	48	20	150	200			
HLKT-K-R/L-2525-200-350-4-T20	25	25	150	48	20	200	350			
HLKT-K-R/L-2525-300-500-4-T20	25	25	150	48	20	300	500			

KRIV Compatible With

Perfect Cut

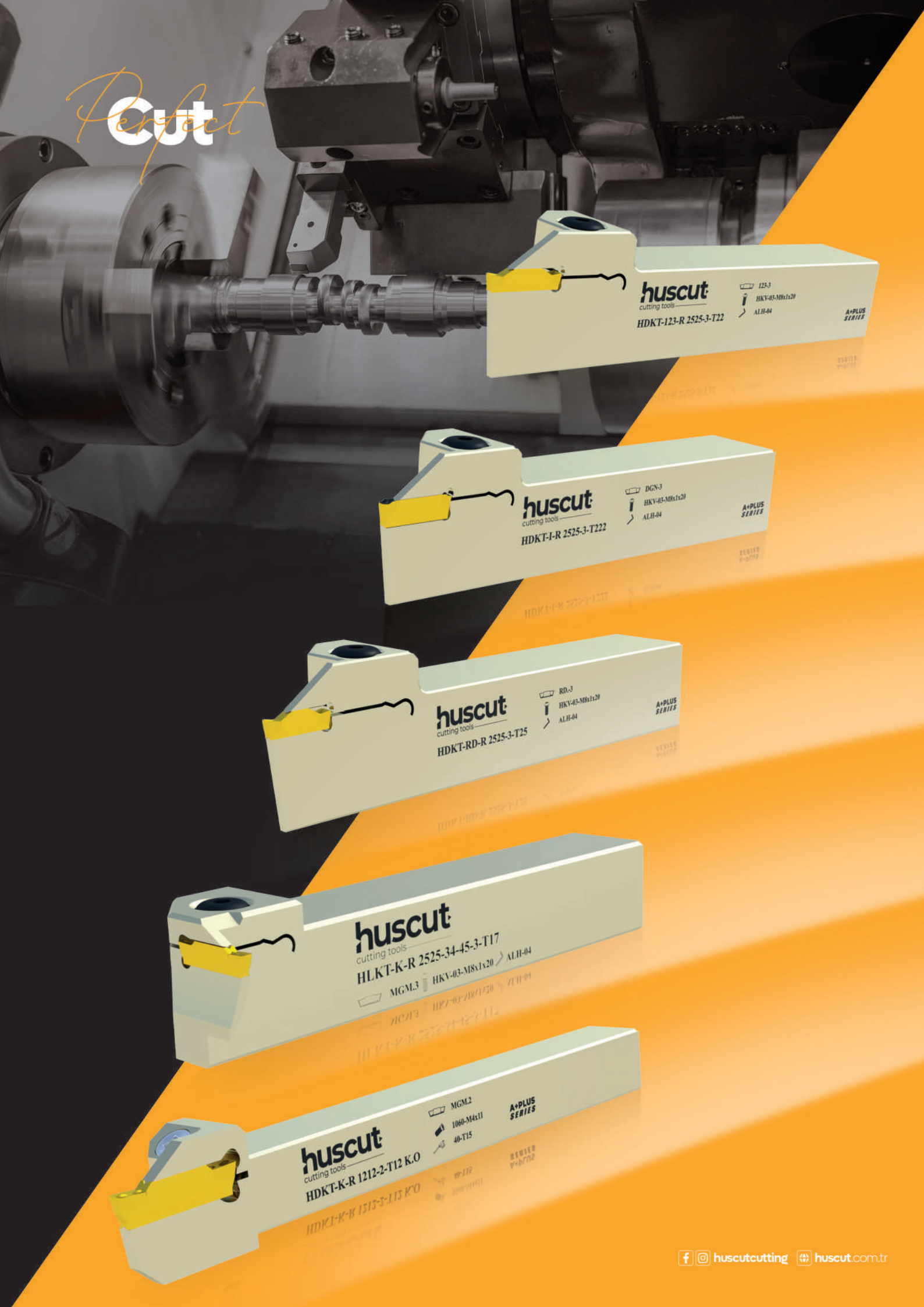

huscut
cutting tools
HDKT-123-R 2525-3-T22

123-3
HKV-03-M8x120
ALH-04

A+PLUS
SERIES



huscut
cutting tools
HDKT-I-R 2525-3-T222

DGN-3
HKV-03-M8x120
ALH-04

A+PLUS
SERIES



huscut
cutting tools
HDKT-RD-R 2525-3-T25

RD-3
HKV-03-M8x120
ALH-04

A+PLUS
SERIES



huscut
cutting tools
HLKT-K-R 2525-34-45-3-T17

MGM-3 HKV-03-M8x120 ALH-04





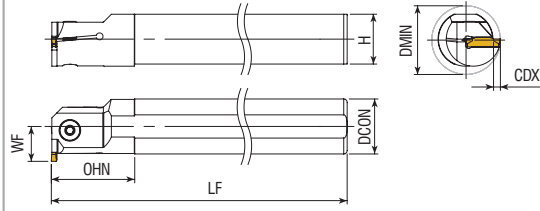
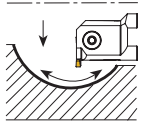

huscut
cutting tools
HDKT-K-R 1212-2-T12 K.O.

MGM-2
1060-M4x11
40-T15

A+PLUS
SERIES



 Takım Kodu Ordering Code Bestell-Bezeichnung	Takım Ölçüleri (mm) Dimension (mm) Abmessung (mm)							Kesici Uç Insert Wendeschnei-Platte	Sıkma Vidası Screw Schrauble	Anahtar Allen Key Torx Schlüssel
	DCON	DMIN	LF	OHN	CDX	H	WF			
HIKT-K-R/L-16-15-T4	16	21	150	28	4	14.8	12	MGM1.5	HKV-01-M4x10	HAL-03
HIKT-K-R/L-20-15-T4	20	25	170	30	4	18.3	14		HKV-02-M4x12	
HIKT-K-R/L-16-2-T4	16	21	150	28	4	14.8	12	MGM.2	HKV-01-M4x10	HAL-03
HIKT-K-R/L-20-2-T4	20	25	170	30	4	18.3	14		HKV-02-M4x12	
HIKT-K-R/L-25-2-T6	25	32	200	40	6	23	18.5	MGM.3	HKV-03-M5x12	HAL-04
HIKT-K-R/L-20-3-T6	20	27	170	30	6	18.3	16			
HIKT-K-R/L-25-3-T6	25	32	200	40	6	23	18.5			
HIKT-K-R/L-25-3-T10	25	32	200	48	10	23	18.5			
HIKT-K-R/L-32-3-T6	32	39	250	50	6	30	22			
HIKT-K-R/L-32-3-T12	32	39	250	53	12	30	22			
HIKT-K-R/L-40-3-T6	40	47	300	55	6	37.5	26			
HIKT-K-R/L-40-3-T12	40	48	300	63	12	37.5	27			
HIKT-K-R/L-20-4-T6	20	27	170	30	6	18.3	16			
HIKT-K-R/L-25-4-T6	25	32	200	40	6	23	18.5			
HIKT-K-R/L-25-4-T10	25	32	200	49	10	23	18.5	MGM.4	HKV-03-M5x12	HAL-04
HIKT-K-R/L-32-4-T6	32	39	250	50	6	30	22			
HIKT-K-R/L-32-4-T12	32	39	250	53	12	30	22			
HIKT-K-R/L-40-4-T6	40	47	300	55	6	37.5	26			
HIKT-K-R/L-40-4-T12	40	48	300	63	12	37.5	27	MGM.5	HKV-06-M8x1x20	HAL-04
HIKT-K-R/L-25-5-T7	25	33	200	40	7	23	19.5			
HIKT-K-R/L-32-5-T7	32	40	250	50	7	30	23			
HIKT-K-R/L-40-5-T7	40	48	300	55	7	37.5	27			
HIKT-K-R/L-40-5-T12	40	48	300	63	12	37.5	27			
HIKT-K-R/L-32-6-T7	32	40	250	50	7	30	23			
HIKT-K-R/L-40-6-T12	40	48	200	63	12	37.5	27	MGM.6	HKV-06-M8x1x20	HAL-04
HIKT-K-R/L-50-6-T12	50	60	350	73	12	47	32			

KRLV Compatible With



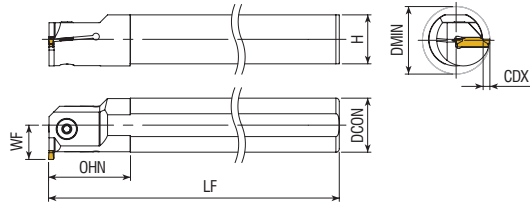
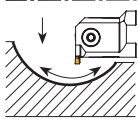

 Takım Kodu Ordering Code Bestell-Bezeichnung	Takım Ölçüleri (mm) Dimension (mm) Abmessung (mm)							Kesici Uç Insert Wendeschnei-Platte	Sıkma Vidası Screw Schrauble	Anahtar Allen Key Torx Schlüssel
	DCON	DMIN	LF	OHN	CDX	H	WF			
HIKT-KG-R/L-20-2-T6	20	27	170	30	6	18.3	16	KG2	HKV-02-M4x12	HAL-03
HIKT-KG-R/L-25-2-T7	25	33	200	40	7	23	19.5			
HIKT-KG-R/L-20-3-T6	20	27	170	30	6	18.3	16	KG3	HKV-03-M5x12	HAL-04
HIKT-KG-R/L-25-3-T7	25	33	200	40	7	23	19.5			
HIKT-KG-R/L-32-3-T8	32	41	250	50	8	30	24	KG4	HKV-06-M8x1x20	
HIKT-KG-R/L-40-3-T8	40	50	300	55	8	37.5	28			
HIKT-KG-R/L-25-4-T7	25	33	200	40	7	23	19.5	KG4	HKV-03-M5x12	
HIKT-KG-R/L-32-4-T8	32	41	250	50	8	30	24			
HIKT-KG-R/L-40-4-T8	40	50	300	55	8	37.5	28			

KRTV Compatible With

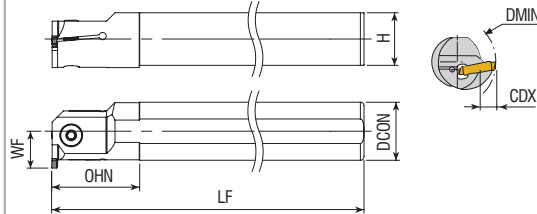
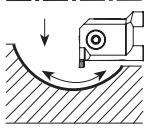





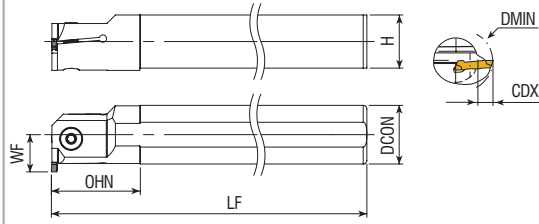
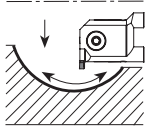

 Takım Kodu Ordering Code Bestell-Bezeichnung	Takım Ölçüleri (mm) Dimension (mm) Abmessung (mm)							Kesici Uç Insert Wendeschnei-Platte	Sıkma Vidası Screw Schrauble	Anahtar Allen Key Torx Schlüssel
	DCON	DMIN	LF	OHN	CDX	H	WF			
HIKT-H-R/L-25-3-T7	25	33	200	40	7	23	19.5	S229-3	HKV-03-M5x12	HAL-04
HIKT-H-R/L-32-3-T8	32	41	250	50	8	30	24			
HIKT-H-R/L-40-3-T10	40	50	300	55	10	37.5	30	S229-4	HKV-06-M8x1x20	
HIKT-H-R/L-25-4-T7	25	33	200	40	7	23	19.5			
HIKT-H-R/L-32-4-T8	32	41	250	50	8	30	24	S229-5	HKV-03-M5x12	
HIKT-H-R/L-40-4-T10	40	50	300	55	10	37.5	30			
HIKT-H-R/L-25-5-T7	25	33	200	40	7	23	19.5	S229-5	HKV-03-M5x12	
HIKT-H-R/L-32-5-T8	32	41	250	50	8	30	24			
HIKT-H-R/L-40-5-T10	40	50	300	55	10	37.5	30			

HRTV Compatible With









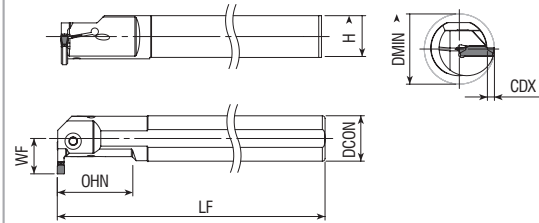
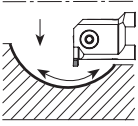

 Takım Kodu Ordering Code Bestell-Bezeichnung	Takım Ölçüleri (mm) Dimension (mm) Abmessung (mm)							Kesici Uç Insert Wendeschnelplatte	Sıkma Vidası Screw Schrauble	Anahtar Allen Key Torx Schlüssel
	DCON	DMIN	LF	OHN	CDX	H	WF			
HIKT-HK-R/L-20-2-T6	20	27	170	30	6	18.3	16	S224-2		HAL-03
HIKT-HK-R/L-25-2-T7	25	33	200	40	7	23	19.5			
HIKT-HK-R/L-20-3-T6	20	27	170	30	6	18.3	16	S224-3		HAL-04
HIKT-HK-R/L-25-3-T7	25	33	200	40	7	23	19.5			
HIKT-HK-R/L-32-3-T8	32	41	250	50	8	30	24	S224-4		HAL-04
HIKT-HK-R/L-20-4-T6	20	27	170	30	6	18.3	16			
HIKT-HK-R/L-25-4-T7	25	33	200	40	7	23	19.5			
HIKT-HK-R/L-32-4-T8	32	41	250	50	8	30	24			







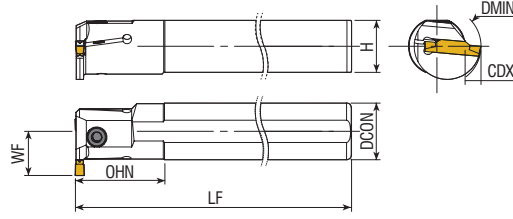
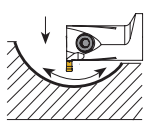

HM Compatible With



 Takım Kodu Ordering Code Bestell-Bezeichnung	Takım Ölçüleri (mm) Dimension (mm) Abmessung (mm)							Kesici Uç Insert Wendeschnelplatte	Sıkma Vidası Screw Schrauble	Anahtar Allen Key Torx Schlüssel
	DCON	DMIN	LF	OHN	CDX	H	WF			
HIKT-KM-R/L-20-2-T6	20	24	170	40	6	18.3	16	A4-2		HAL-03
HIKT-KM-R/L-25-2-T6	25	28	200	50	6	23	18.5			
HIKT-KM-R/L-20-3-T6	20	24	170	40	6	18.3	16	A4-3		HAL-04
HIKT-KM-R/L-25-3-T6	25	28	200	50	6	23	18.5			
HIKT-KM-R/L-32-3-T8	32	36	250	64	8	30	24	A4-4		HAL-04
HIKT-KM-R/L-20-4-T6	20	24	170	40	6	18.3	16			
HIKT-KM-R/L-25-4-T6	25	28	200	50	6	23	18.5			
HIKT-KM-R/L-32-4-T8	32	36	190	104	8	31	24			









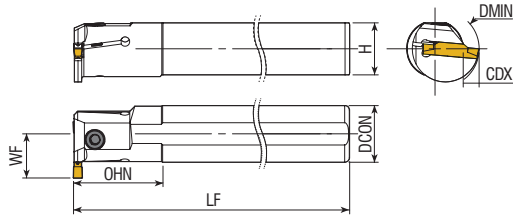
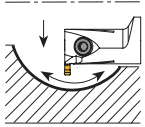

 Takım Kodu Ordering Code Bestell-Bezeichnung	Takım Ölçüleri (mm) Dimension (mm) Abmessung (mm)							Kesici Uç Insert Wendeschnel-Platte	Sıkma Vidası Screw Schraube	Anahtar Allen Key Torx Schlüssel
	DCON	DMIN	LF	OHN	CDX	H	WF			
HIKT-123-R/L-20-2-T6	20	27	170	30	6	18.3	16	123-2		HAL-03
HIKT-123-R/L-25-2-T7	25	33	200	40	7	23	19.5			
HIKT-123-R/L-32-2-T8	32	41	250	45	8	30	24			
HIKT-123-R/L-20-3-T6	20	27	170	30	6	18.3	16	123-3		HAL-04
HIKT-123-R/L-25-3-T7	25	33	200	40	7	23	19.5			
HIKT-123-R/L-32-3-T8	32	41	250	50	8	30	24			
HIKT-123-R/L-20-4-T6	20	27	170	30	6	18.3	16	123-4		HAL-04
HIKT-123-R/L-25-4-T7	25	33	200	40	7	23	19.5			
HIKT-123-R/L-32-4-T8	32	41	250	45	8	30	24			
HIKT-123-R/L-25-5-T7	25	33	200	40	7	23	19.5	123-5		HAL-04
HIKT-123-R/L-32-5-T8	32	41	250	50	8	30	24			

SNDK Compatible With





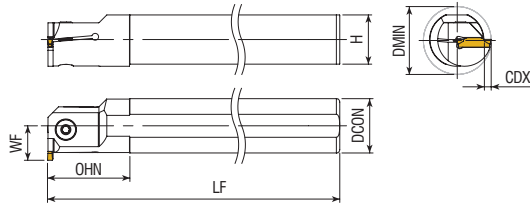
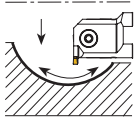

 Takım Kodu Ordering Code Bestell-Bezeichnung	Takım Ölçüleri (mm) Dimension (mm) Abmessung (mm)							Kesici Uç Insert Wendeschnel-Platte	Sıkma Vidası Screw Schraube	Anahtar Allen Key Torx Schlüssel
	DCON	DMIN	LF	OHN	CDX	H	WF			
HIKT-TD-R/L-16-2-T4	16	25	150	28	4	14.8	12	TD-2		HAL-03
HIKT-TD-R/L-20-2-T6	20	27	170	30	6	18.3	16			
HIKT-TD-R/L-25-2-T7	25	33	200	40	7	23	19.5			
HIKT-TD-R/L-20-3-T6	20	27	170	30	6	18.3	16	TD-3		HAL-04
HIKT-TD-R/L-25-3-T7	25	33	200	40	7	23	19.5			
HIKT-TD-R/L-32-3-T8	32	35	250	50	8	30	22			
HIKT-TD-R/L-20-4-T6	20	27	170	30	6	18.3	16	TD-4		HAL-04
HIKT-TD-R/L-25-4-T7	25	33	200	40	7	23	19.5			
HIKT-TD-R/L-32-4-T8	32	35	250	50	8	30	22			

TGTG Compatible With







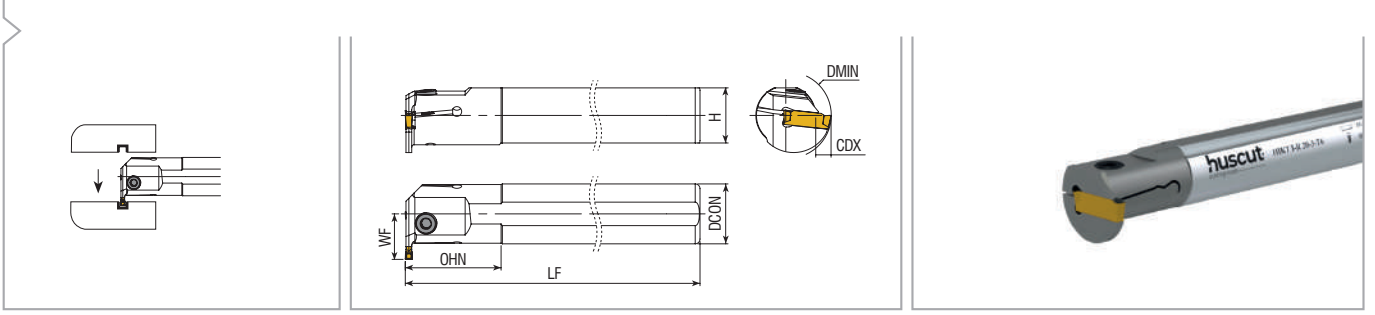

 Takım Kodu Ordering Code Bestell-Bezeichnung	Takım Ölçüleri (mm) Dimension (mm) Abmessung (mm)							Kesici Uç Insert Wendeschnel-Platte	Sıkma Vidası Screw Schraube	Anahtar Allen Key Torx Schlüssel
	DCON	DMIN	LF	OHN	CDX	H	WF			
HIKT-RD-R/L-16-2-T6	16	24	150	28	6	14.8	14	RD.-2	HKV-01-M4x10	HAL-03
HIKT-RD-R/L-20-2-T6	20	28	170	28	6	18.3	16		HKV-02-M4x12	HAL-04
HIKT-RD-R/L-25-2-T7	25	34	200	28	7	23	19.5		HKV-03-M5x12	HAL-04
HIKT-RD-R/L-16-3-T6	16	24	150	28	6	14.8	14	RD.-3	HKV-01-M4x10	HAL-03
HIKT-RD-R/L-20-3-T6	20	28	170	28	6	18.3	16		HKV-03-M5x12	HAL-04
HIKT-RD-R/L-25-3-T7	25	34	200	28	7	23	19.5		HKV-06-M8x1x20	HAL-04
HIKT-RD-R/L-32-3-T8	32	42	250	50	8	30	24	RD.-4	HKV-03-M5x12	HAL-04
HIKT-RD-R/L-20-4-T6	20	28	170	28	6	18.3	16		HKV-03-M5x12	HAL-04
HIKT-RD-R/L-25-4-T7	25	34	200	28	7	23	19.5		HKV-03-M5x12	HAL-04
HIKT-RD-R/L-32-4-T8	32	42	250	50	8	30	24		HKV-06-M8x1x20	HAL-04

T6TC Compatible With







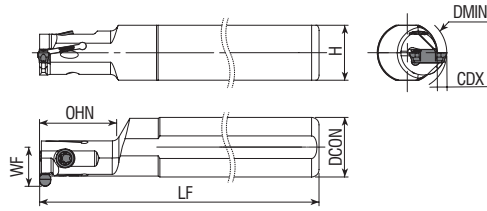
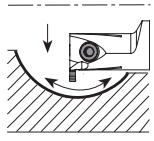

 Takım Kodu Ordering Code Bestell-Bezeichnung	Takım Ölçüleri (mm) Dimension (mm) Abmessung (mm)							Kesici Uç Insert Wendeschnel-Platte	Sıkma Vidası Screw Schrauble	Anahtar Allen Key Torx Schlüssel
	DCON	DMIN	LF	OHN	CDX	H	WF			
HIKT-I-R/L-20-3-T6	20	27	170	30	6	18.3	16	DGN - 3	HKV-03-M5x12	HAL-04
HIKT-I-R/L-25-3-T7	25	33	200	40	7	23	19.5		HKV-06-M8x1x20	
HIKT-I-R/L-32-3-T8	32	41	250	50	8	30	24		HKV-01-M4x10	
HIKT-IG-R/L-16-3-T4	16	21	150	30	4	14.8	15	GRP - 3	HKV-03-M5x12	HAL-03
HIKT-IG-R/L-20-3-T6	20	27	170	30	6	18.3	16		HKV-06-M8x1x20	
HIKT-IG-R/L-25-3-T7	25	33	200	40	7	23	19.5		HKV-03-M5x12	
HIKT-IG-R/L-32-3-T8	32	41	250	50	8	30	24		HKV-06-M8x1x20	
HIKT-IG-R/L-25-4-T7	25	33	200	40	7	23	19.5	DGN/GRP - 4	HKV-03-M5x12	HAL-04
HIKT-IG-R/L-32-4-T8	32	41	250	50	8	30	24		HKV-06-M8x1x20	
HIKT-IG-R/L-40-4-T10	40	51	300	55	10	37.5	30	DGN/GRP - 5	HKV-03-M5x12	HAL-04
HIKT-IG-R/L-25-5-T7	25	33	200	40	7	23	19.5		HKV-06-M8x1x20	
HIKT-IG-R/L-32-5-T8	32	41	250	50	8	30	24		HKV-03-M5x12	
HIKT-IG-R/L-40-5-T10	40	51	300	55	10	37.5	30		HKV-06-M8x1x20	

ISCR Compatible With







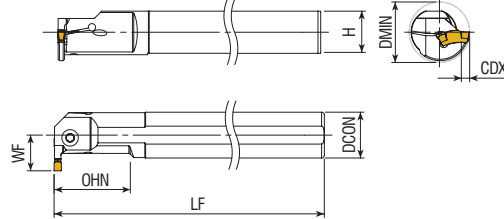
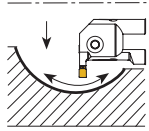

 Takım Kodu Ordering Code Bestell-Bezeichnung	Takım Ölçüleri (mm) Dimension (mm) Abmessung (mm)							Kesici Uç Insert Wendeschnel-Platte	Sıkma Vidası Screw Schrauble	Anahtar Allen Key Torx Schlüssel
	DCON	DMIN	LF	OHN	CDX	H	WF			
HIKT-IGP-R/L-10-2-T2.5	10	11.5	125	25	2.5	9	8.3	GEPI-2	1045-M3x8	HTA-T08
HIKT-IGP-R/L-12-2-T2.5	12	11.5	125	25	2.5	11	9			
HIKT-IGP-R/L-16-2-T2.5	16	13	125	20	2.5	14.3	10.5	GEPI-3	1045-M4x11	HTA-T15
HIKT-IGP-R/L-16-3-T2.5	16	13	125	20	2.5	14.3	10.5			

ISCR Compatible With



 Takım Kodu Ordering Code Bestell-Bezeichnung	Takım Ölçüleri (mm) Dimension (mm) Abmessung (mm)							Kesici Uç Insert Wendeschnel-Platte	Sıkma Vidası Screw Schrauble	Anahtar Allen Key Torx Schlüssel
	DCON	DMIN	LF	OHN	CDX	H	WF			
HIKT-ITG-R/L-16-3-T6	16	20	150	25	6	14.8	12	TGM.-3	1060-M4.5x16	HTA-T20
HIKT-ITG-R/L-20-3-T6	20	25	170	32	6	18.3	14.5		HKV-03-M5x12	HAL-04
HIKT-ITG-R/L-25-3-T8	25	32	200	40	8	23	19		HKV-06-M8x1x20	
HIKT-ITG-R/L-20-4-T6	20	25	170	33	6	18.3	14.5	TGM.-4	1060-M4.5x16	HTA-T20
HIKT-ITG-R/L-25-4-T8	25	32	200	42	8	23	19		HKV-03-M5x12	HAL-04
HIKT-ITG-R/L-32-4-T12	32	43	250	50	12	30	25.5		HKV-06-M8x1x20	HAL-04
HIKT-ITG-R/L-40-4-T12	40	54	300	50	12	37.5	32			HAL-04

ISCR Compatible With

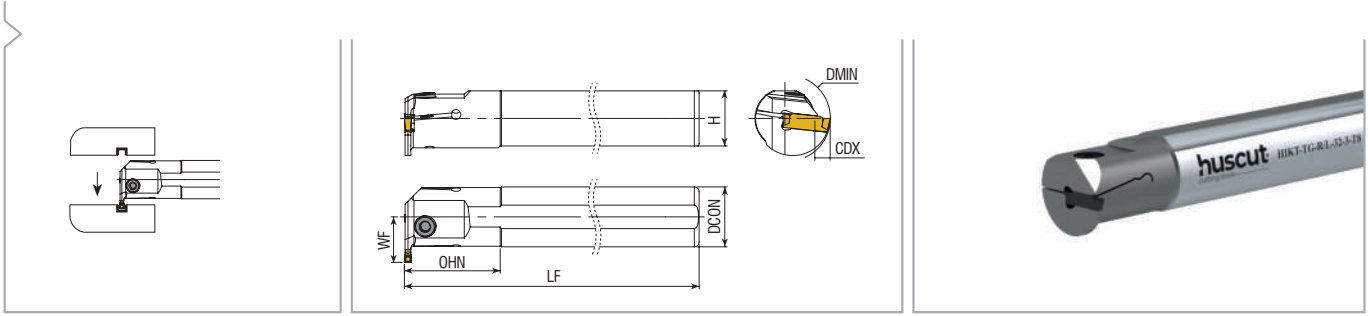

 Takım Kodu Ordering Code Bestell-Bezeichnung	Takım Ölçüleri (mm) Dimension (mm) Abmessung (mm)							Kesici Uç Insert Wendeschnel-Platte	Sıkma Vidası Screw Schrauble	Anahtar Allen Key Torx Schlüssel
	DCON	DMIN	LF	OHN	CDX	H	WF			
HIKT-TG-R/L-20-2-T6	20	28	160	28	6	18.3	16	DGM2-020	HKV-02-M4x12	HAL-03
HIKT-TG-R/L-25-2-T7	25	32	200	28	7	23	19.5			
HIKT-TG-R/L-20-3-T6	20	28	160	28	6	18.3	16	DGM3-020	HKV-03-M5x12	HAL-04
HIKT-TG-R/L-25-3-T7	25	32	200	28	7	23	19.5			
HIKT-TG-R/L-32-3-T8	32	42	250	50	8	30	25			
HIKT-TG-R/L-25-4-T7	25	32	200	28	7	23	19.5	DGM4-030	HKV-03-M5x12	HAL-04
HIKT-TG-R/L-32-4-T8	32	42	250	50	8	30	25			

TNG/Compatible With

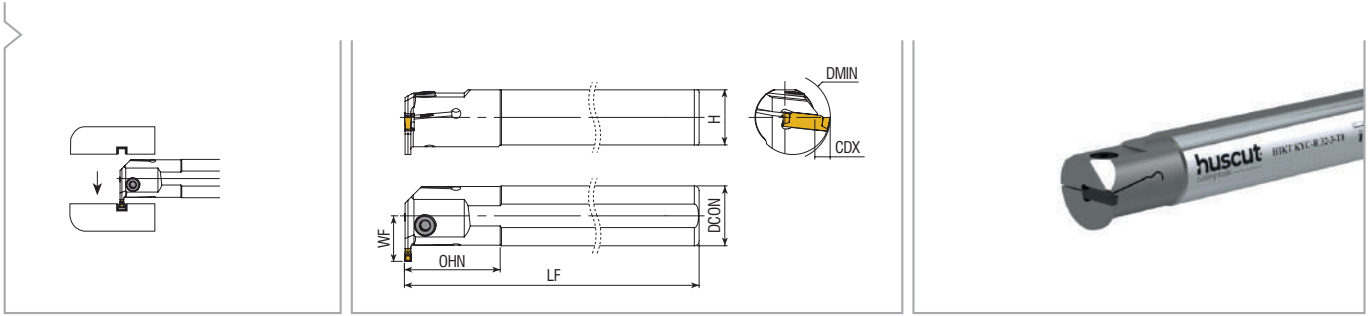



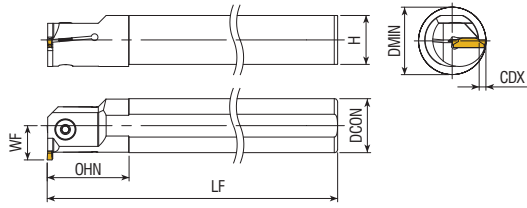
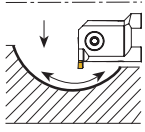

 Takım Kodu Ordering Code Bestell-Bezeichnung	Takım Ölçüleri (mm) Dimension (mm) Abmessung (mm)							Kesici Uç Insert Wendeschnel-Platte	Sıkma Vidası Screw Schrauble	Anahtar Allen Key Torx Schlüssel
	DCON	DMIN	LF	OHN	CDX	H	WF			
HIKT-KYC-R/L-20-2-T6	20	28	160	28	6	18.3	16	GDM 2020	HKV-02-M4x12	HAL-03
HIKT-KYC-R/L-25-2-T7	25	32	200	28	7	23	19.5			
HIKT-KYC-R/L-20-3-T6	20	28	160	28	6	18.3	16	GDM 3020	HKV-03-M5x12	HAL-04
HIKT-KYC-R/L-25-3-T7	25	32	200	28	7	23	19.5			
HIKT-KYC-R/L-32-3-T8	32	42	250	50	8	30	25			
HIKT-KYC-R/L-20-4-T6	20	28	160	28	6	18.3	16	GDM 4020	HKV-03-M5x12	HAL-04
HIKT-KYC-R/L-25-4-T7	25	32	200	28	7	23	19.5			
HIKT-KYC-R/L-32-4-T8	32	42	250	50	8	30	25			

KYCR Compatible With







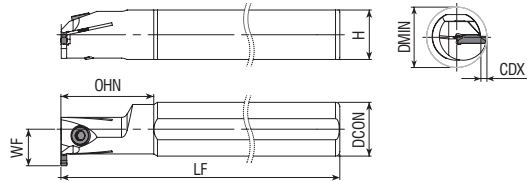
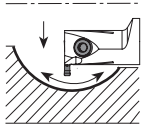

 Takım Kodu Ordering Code Bestell-Bezeichnung	Takım Ölçüleri (mm) Dimension (mm) Abmessung (mm)							Kesici Uç Insert Wendeschnei Platte	Sıkma Vidası Screw Schraube	Anahtar Allen Key Torx Schlüssel
	DCON	DMIN	LF	OHN	CDX	H	WF			
HIKT-ZCC2-R/L-16-2-T4	16	21	150	28	4	14.8	12	ZBD-2	HKV-01-M4x10	HAL-03
HIKT-ZCC2-R/L-20-2-T6	20	27	170	30	6	18.3	16		HKV-02-M4x12	
HIKT-ZCC2-R/L-20-3-T6	20	27	170	30	6	18.3	16	ZFD-3	HKV-03-M5x12	HAL-04
HIKT-ZCC2-R/L-25-3-T7	25	33	200	40	7	23	19.5		HKV-06-M8x1x20	
HIKT-ZCC2-R/L-32-3-T8	32	41	250	50	8	30	24		HKV-03-M5x12	
HIKT-ZCC2-R/L-40-3-T10	40	51	300	55	10	37.5	30	ZGD-4	HKV-06-M8x1x20	HAL-04
HIKT-ZCC2-R/L-25-4-T7	25	33	200	40	7	23	19.5		HKV-03-M5x12	
HIKT-ZCC2-R/L-32-4-T8	32	41	250	50	8	30	24	ZHD-5	HKV-06-M8x1x20	HAL-04
HIKT-ZCC2-R/L-40-4-T10	40	51	300	55	10	37.5	30		HKV-06-M8x1x20	
HIKT-ZCC2-R/L-32-5-T8	32	41	250	50	8	30	24	ZHD-5	HKV-06-M8x1x20	HAL-04
HIKT-ZCC2-R/L-40-5-T10	40	51	300	55	10	37.5	30		HKV-06-M8x1x20	

ZCC Compatible With



 Takım Kodu Ordering Code Bestell-Bezeichnung	Takım Ölçüleri (mm) Dimension (mm) Abmessung (mm)							Kesici Uç Insert Wendeschnei Platte	Sıkma Vidası Screw Schraube	Anahtar Allen Key Torx Schlüssel
	DCON	DMIN	LF	OHN	CDX	H	WF			
HIKT-SGC-R/L-20-2-T6	25	27	200	40	6	23	16	GCMN20	HKV-02-M4x12	HAL-03
HIKT-SGC-R/L-25-2-T7	25	33	200	40	7	23	19.5		HKV-03-M5x12	
HIKT-SGC-R/L-25-3-T7	25	33	200	40	7	23	19.5	GCMN30	HKV-06-M8x1x20	HAL-04
HIKT-SGC-R/L-32-3-T8	32	41	250	50	8	30	24		HKV-03-M5x12	
HIKT-SGC-R/L-40-3-T10	40	51	300	55	10	37.5	30		HKV-06-M8x1x20	

SGC Compatible With

Perfect
Cut





Diş Açma Takımları

Threading Toolholders

Gewinde Drehhalter



S

E

R

25-25

M

16

» 1

Sıkma Tipi
Clamping Type
Klemmart

Vida Sıkmalı

Screw Clamping

Schrauben-Spannsystem

S

Vida Sıkmalı Helis Açılı

Screw Clamping with Helix Angle

Schraubenklemmung für unterschiedliche Einstellwinkel

T

» 2

İşlem Tipi
Process Type
Prozesstyp

Dış

External

Außen

E

İç

Internal

Internal Innen

I

» 3

Kesme Yönü
Cutting Direction
Schnittrichtung

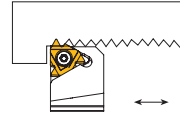

SER

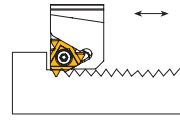

SEL

» 4

Kenar Yüksekliği
Edge Height
Kantenhöhe

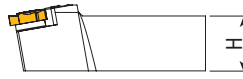

» 5

Şaft Boyu
Shank Length
Schaftlänge

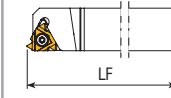

A-32	M-150
B-40	N-160
C-50	P-170
D-60	Q-180
E-70	R-200
F-80	S-250
G-90	T-300
H-100	U-350
J-110	V-400
K-125	W-450
L-140	X-Special

» 6

Elmas Ölçüsü
Insert Size
Wendeplattengröße

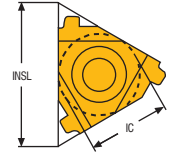

l (mm)	d
06	5/32"
08	3/16"
11	1/4"
16	3/8"
22	1/2"
27	5/8"

S

I

R

S

25

R

16

» 1

Sıkma Tipi
Clamping Type
Klemmart

Vida Sıkmalı

Screw Clamping

Schrauben-Spannsystem

S

Vida Sıkmalı Helis Açılı

Screw Clamping with Helix Angle

Schraubenklemmung für unterschiedliche Einstellwinkel

T

» 2

İşlem Tipi
Process Type
Prozesstyp

Dış Çap

Outer Diameter

Außendurchmesser

E

İç Çap

Inner diameter

Innendurchmesser

I

» 3

Kesme Yönü
Cutting Direction
Schnittrichtung



SIR



SIL

» 4

İşlem Tipi
Process Type
Prozesstyp

Yekpare çelik gövde soğutma suyu kanallı

Solid steel body with cooling water channel

Massiver Stahlkörper mit Kühlwasserkanal

A

Çelik başlıkla sert metal gövde ve soğutma suyu kanallı

Hard metal body and coolant channels with steel cap

Hartmetallkörper und Kühlmittelkanäle mit Stahlkappe

E

Karbür Şaft

Carbide shank

Hartmetallwelle

C

Çelik Şaft

Steel shank

Stahlwelle

S

» 5

Şaft Çapı

Shank Diameter
Schaft Durchmesser

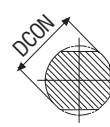

» 6

Şaft Boyu
Shank Length
Schaftlänge

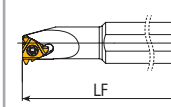

A-32	M-150
B-40	N-160
C-50	P-170
D-60	Q-180
E-70	R-200
F-80	S-250
G-90	T-300
H-100	U-350
J-110	V-400
K-125	W-450
L-140	X-Special





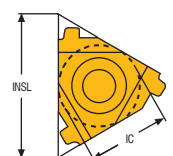

» 7

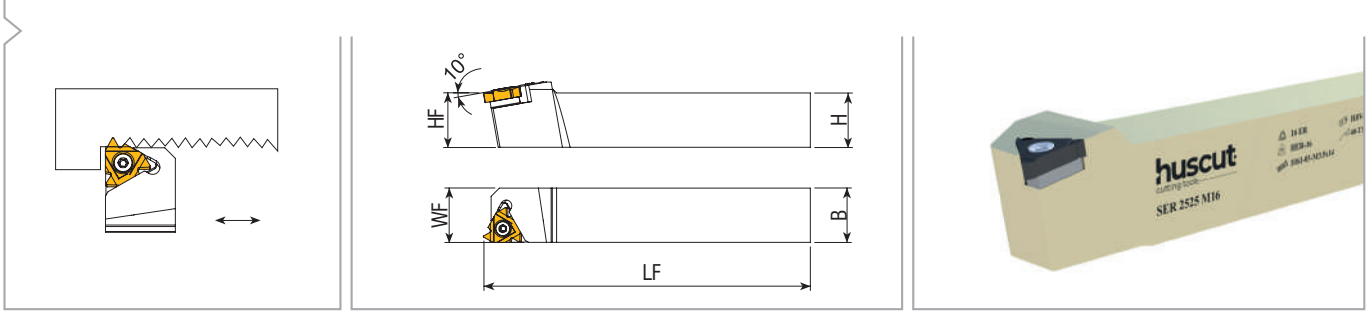
Elmas Ölçüsü
Insert Size
Wendeplattengröße



l (mm)	d
06	5/32"
08	3/16"
11	1/4"
16	3/8"
22	1/2"
27	5/8"



 Takım Kodu Ordering Code Bestell-Bezeichnung	Takım Ölçüleri (mm) Dimension (mm) Abmessung (mm)				Kesici Uç Insert Wendeschnei Platte	Sıkma Vidası Screw Schrauble	Altık Shim Unterlage	Altık Vidası Shim Screw Schraube für Unterlage	Pul Shim Ring	Tork Anahtar Torx Key Torx Schlüssel
	HF=H	B	LF	WF						
SER/L 0808 E11	8	8	70	11						
SER/L 1010 E11	10	10	70	11						
SER/L 1212 F11	12	12	80	12	11 ER/EL	1060-M2.5x6	-	-		HTA-T08
SER/L 1616 H11	16	16	100	16						
SER/L 2020 H11	20	20	100	20						
SER/L 1616 H16	16	16	100	16						
SER/L 2020 K16	20	20	125	20	16 ER/EL	1060-M3.5x14	HER-16	HBV-02-M3.5x11		HTA-T15
SER/L 2525 M16	25	25	150	25						
SER/L 3232 P16	32	32	170	32						
SER/L 2525 M22	25	25	150	25						
SER/L 3232 P22	32	32	170	32	22 ER/EL	1060-M4.5x16	HER-22	HBV-04-M4.5x13		HTA-T20
SER/L 4040 S22	40	40	250	40						
SER/L 2525 M16-T	25	25	150	25	16 ER/EL	1060-M3.5x14	-	-		HTA-T15
SER/L 3232 M16-T	32	32	170	32						
SER/L 2525 M22-T	25	25	150	25	22 ER/EL	1060-M4.5x16	-	-		HTA-T20
SER/L 3232 M22-T	32	32	170	32						

ISO Comptipie With

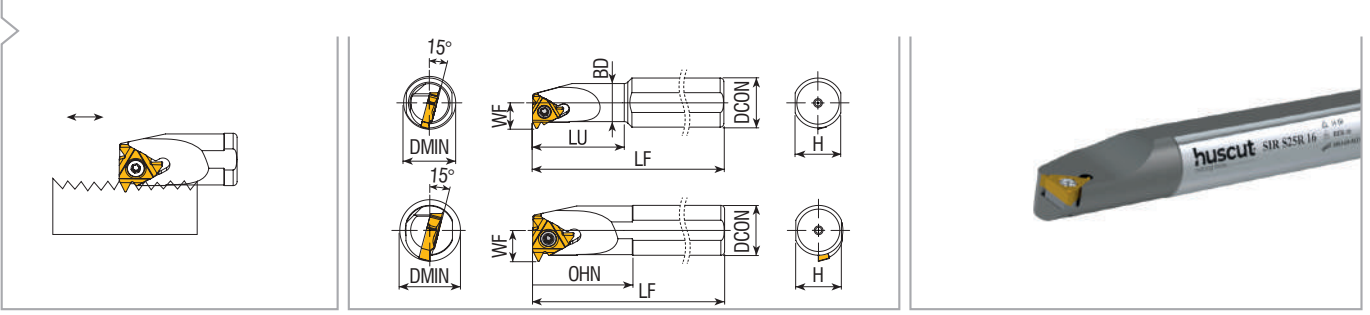





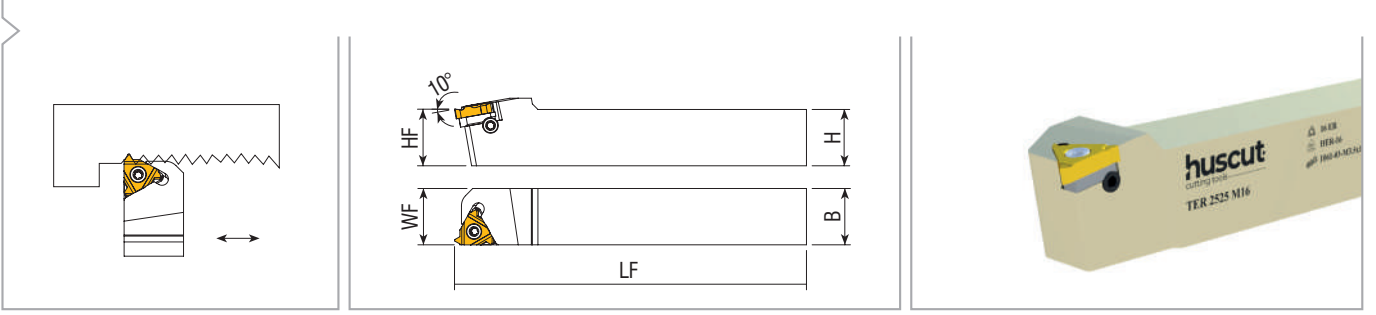

Takım Kodu Ordering Code Bestell-Bezeichnung	Takım Ölçüleri (mm) Dimension (mm) Abmessung (mm)						Kesici Uç Insert Wendeschneid- Platte	Sıkma Vidası Screw Schraube	Altık Shim Unterlage	Altık Vidası Shim Screw Schraube für Unterlage	Pul Shim Ring	Tork Anahtar Torx Key Torx Schlüssel
	DCON	BD	LF	LU = OHN	WF	DMIN						
SIR/L S12X05H 06	12	5	100	15	4.3	6.4	06 IR/L	1060-M2x4	-	-		HTA-T06
SIR/L S16X05H 06	16	5	100	15	4.3	6.4						
SIR/L S16X07M 08	16	7	150	18	5.3	7.8	08 IR/L	1060-M2.2x5	-	-		HTA-T07
SIR/L S10H 11	10	10	100	-	7.4	12						
SIR/L S12K 11	12	12	125	-	8.4	16						
SIR/L S16X10M 11	16	10	150	25	7.4	12	11 IR/L	1060-M2.5x6	-	-		HTA-T08
SIR/L S16X13M 11	16	13	150	32	8.9	15						
SIR/L S16M 11	16	16	150	-	11.7	19						
SIR/L S16X13M 16	16	13	150	32	10.2	16		1060-M3.5x9				
SIR/L S16M 16	16	16	150	-	11.7	19						
SIR/L S20X16P 16	20	16	170	40	11.7	19		1060-M3.5x12	-	-		
SIR/L S20P 16	20	20	170	-	13.7	24	16 IR/L					HTA-T15
SIR/L S25R 16	25	25	200	-	16.2	29						
SIR/L S32S 16	32	32	250	-	19.7	36		1060-M3.5x14	HER-16	HBV-02- M3.5x11		
SIR/L S40T 16	40	40	300	-	23.7	44						
SIR/L S50U 16	50	50	350	-	28.7	54						
SIR/L S20P 22	20	20	170	-	15.7	24		1060-M4.5x12	-	-		
SIR/L S25R 22	25	25	200	-	18.1	29						
SIR/L S32S 22	32	32	250	-	21.6	38	22 IR/L	1060-M4.5x16	HER-22	HBV-04- M4.5x13		HTA-T20
SIR/L S40T 22	40	40	300	-	25.6	46						
SIR/L S50U 22	50	50	350	-	30.6	58						
SIR/L S25R 16-T	25	25	200	-	16.2	29	16-T IR/L	1060-M3.5x14	-	-		HTA-T15
SIR/L S32S 16-T	32	32	250	-	19.7	36						
SIR/L S25R 22-T	25	25	200	-	18.1	29	22-T IR/L	1060-M4.5x16	-	-		HTA-T20
SIR/L S32S 22-T	32	32	250	-	21.6	38						

ISO Comptipite With









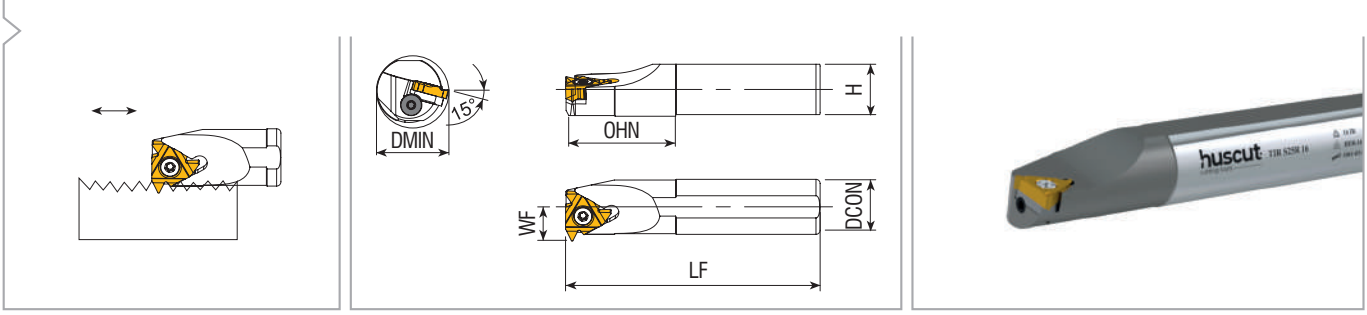

 Takım Kodu Ordering Code Bestell-Bezeichnung	Takım Ölçüleri (mm) Dimension (mm) Abmessung (mm)				Kesici Uç Insert Wendschnei Platte	Sıkma Vidası Screw Schraube	Altık Shim Unterlage	Altık Vidası Shim Screw Schraube für Unterlage	Pul Shim Ring	Tork Anahtar Torx Key Torx Schlüssel
	HF=H	B	LF	WF						
TER/L 1616 H16	16	16	100	16	16 ER/EL	1060-M3.5x12	HTER/L-16	HBV-02-M3.5x11	HPL-03	HTA-T15
TER/L 2020 K16	20	20	125	20						
TER/L 2525 M16	25	25	150	25						
TER/L 3232 P16	32	32	170	32						
TER/L 2525 M22	25	25	150	25	22 ER/EL	1060-M4x14	HTER/L-22	HBV-04-M4.5x13	HPL-04	HTA-T20
TER/L 3232 P22	32	32	170	32						
TER/L 4040 S22	40	40	250	40						
TER/L 2525 M27	25	25	150	25						
TER/L 3232 P27	32	32	170	32	27 ER/EL	1060-M5x18	HTER/L 27			
TER/L 4040 S27	40	40	250	40						

ISO Compatible With





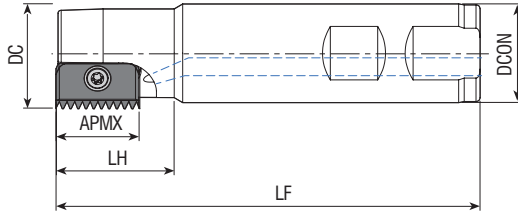

 Takım Kodu Ordering Code Bestell-Bezeichnung	Takım Ölçüleri (mm) Dimension (mm) Abmessung (mm)					Kesici Uç Insert Wendeschnei- Platte	Sıkma Vidası Screw Schraube	Altık Shim Unterlage	Altık Vidası Shim Screw Schraube für Unterlage	Pul Shim Ring	Tork Anahtar Torx Key Torx Schlüssel
	DCON	LF	LU = OHN	WF	DMIN						
TIR/L S25R 16	25	200	-	16.2	29						
TIR/L S32S 16	32	250	-	19.7	36	16 IR/L	1060-M3.5x12	HTER/L-16	HBV-02-M3.5x11	HPL-03	
TIR/L S40T 16	40	300	-	23.7	44						
TIR/L S50U 16	50	350	-	28.7	54						
TIR/L S25R 22	25	200	-	18.1	29						HTA-T15
TIR/L S32S 22	32	250	-	21.6	38	22 IR/L	1060-M4x14	HTER/L-22			
TIR/L S40T 22	40	300	-	25.6	46						
TIR/L S50U 22	50	350	-	30.6	58				HBV-04-M4.5x13	HPL-04	
TIR/L S32S 27	32	250	-	22.6	40						
TIR/L S40T 27	40	300	-	26.6	48	27 IR/L	1060-M5x18	HTER/L 27			HTA-T20
TIR/L S50U 27	50	350	-	31.6	58						
TIR/L A25R 16	25	200	50	16.2	29						
TIR/L A32S 16	32	250	60	19.7	36	16 IR/L	1060-M3.5x12	HTER/L-16	HBV-02-M3.5x11	HPL-03	HTA-T15
TIR/L A40T 16	40	300	65	23.9	44						

ISO Compatible With





 Takım Kodu Ordering Code Bestell-Bezeichnung	Takım Ölçüleri (mm) Dimension (mm) Abmessung (mm)						Kesici Uç Insert Wendeschnei Platte	Sıkma Vidası Screw Schrauble	Tork Anahtar Torx Key Torx Schlüssel
	DC	ZEFP	DCON	LF	LH	APMX			
HDF-C14-D12-W20-L100-Z01-H	12	1	20	100	25	14	C14	1060-M2.5x6	HTA-T08
HDF-C14-D14-W20-L100-Z01-H	14	1	20	100	25	14		1050-M4x9	
HDF-C21-D18-W20-L100-Z01-H	18	1	20	100	30	21	C21	1050-M4x11	HTA-T15
HDF-C21-D21-W25-L125-Z01-H	21	1	25	125	40	21			
HDF-C21-D25-W20-L125-Z01-H	25	1	20	125	30	21			
HDF-C21-D28-W25-L125-Z01-H	28	1	25	125	30	21			
HDF-C21-D38-W32-L125-Z03-H	38	3	32	125	30	21			
HDF-C21-D43-W32-L125-Z03-H	43	3	32	125	30	21			

CPT Compatible With



Perfect Cut



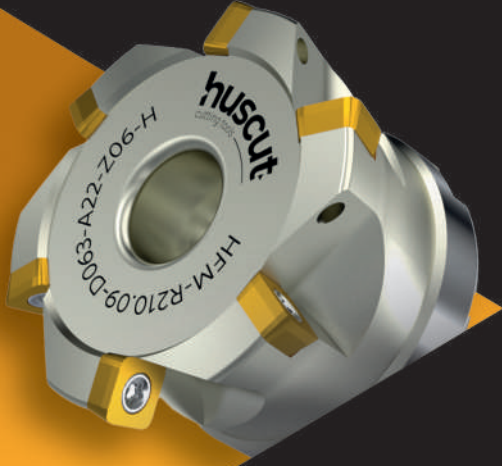

Frezeleme Takımları

Milling Tools Für Fräser

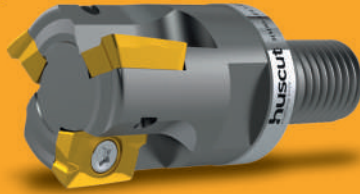

H

M

90

L

A

P

» 1

Marka
Brand
Marke

huscut

» 2

Kesici Stili
Cutter Style
Cutter-Stil

Yüzey Frezeleme Takımları
Face Milling Tools
Eck-und Planfräsköpfe

TM

Alın ve Yüzey Parmak Frezeleri
End Face Milling Tools
Schafffräser

M

Pah Kırma Parmak Frezeleri
Chamfering End Milling Tools
Fasfräser

PF

T Kanal Frezeleri
T Slot Milling Tools
T-Nutenfräser

TF

Yüksek İlerleme Frezeleme Takımları
High Feed Milling Tools
Fräser für hohe Vorschübe

FM

Disk Frezeler
Slot Disc Milling
Scheibenfräser

DFM

Silindirik Alyan Başlı Vida Havşalarını Açma Frezeleri
Countersink Milling Tool for Cylindrical Allen Head Screws
Fräserswerkzeug für zylindrische Inbusschrauben

HCBM

» 3

Freze Yanaşma Açısı
Lead Angle
Anstellwinkel

90°

89°

88°

75°

60°

45°

43°

42°

20°

15°

11°

5°

0°

» 4

Bağlama Stili
Tying Style
Bindestil

Sol
Left
Links

L

Baskı Pabucu
Clamp
Spannspratze

C

Altık
Shim
Unterlage

S

Baskı Pabuçlu Sol Yön
Left Way with Clamp
Spannspratze links

CL

Baskı Pabuçlu Altık
Clamp with Shim
Spannspratze mit Unterlage

CS

Baskı Pabuçlu Altık Sol Yön
Left Way Clamp with Shim
Spannspratze mit Unterlage Links

CSL

» 5

Uç Tipi
Type Of Inset
Plattenform



C



V



D



W



E



A



K



B



L



H



R



M



S



O



T



P

» 6

Serbest Uç Açısı
Free End Angle
Freiwinkel



A



F



B



G



C



N



D



P



E

10

D20

W20

L150

Z03

H

» 7

Kenar Kenar Uzunluğu
Cutting Edge Length
Länge der Schneidkante



» 8

Takım Çapı
Tool Diameter
Werkzeug

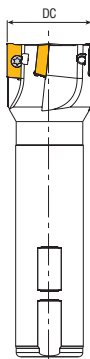

» 9

Montaj Formu ve Çapı
Assembly Form and Diameter
Schaff-und Form

ISO'ya göre montaj formu
Assembly Form and Diameter
Art der Montage und DurchmesserEck-und Planfräsköpfe

A,B,C,D

Silindirik Şaft
Cylindrical Shank
Zylindrischer Schaff

C

Weldon

W

» 10

Takım Boyu
Tool Length
Werkzeug Länge

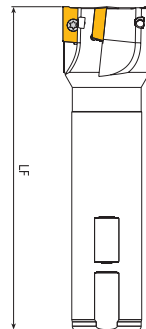

» 11

Etkili Diş Adedi
Number of Effective Tooth
Effektive Zahnzahl

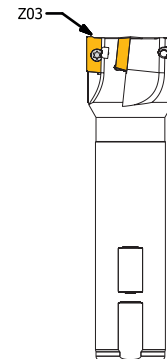

» 12

İçten Soğutmalı
With Coolant Hole
Innenkühlung

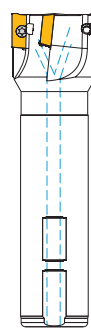

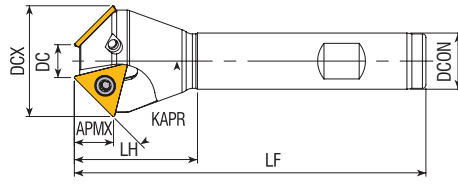
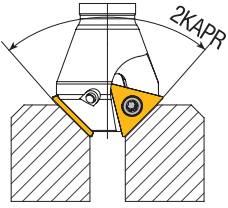

KAPR=-

Takım Kodu
Ordering Code
Bestell-Bezeichnung

Takım Ölçüleri (mm)
Dimension (mm)
Abmessung (mm)

Kesici Uç
Insert
Wendeschnei-
Platte

Sıkma Vidası
Screw
Schraube

Anahtar
Allen Key
Torx Schlüssel

ISO Compatible With

	KAPR	DC	DCX	DCON	LF	LH	Z			
HPF10-TC16-D17X22-W16-L100-Z01	10°	17	22	16	100	30	1	TCT16T3.	1060-M3.5x9	HTA-T15
HPF15-TC16-D17X23-W16-L100-Z01	15°	17	23	16	100	30	1			
HPF15-TC16-D23X29-W16-L100-Z01	15°	23	29	16	100	30	1			
HPF15-TC16-D30X36-W20-L100-Z02	15°	30	36	20	100	35	2			
HPF15-TC16-D35X43-W20-L100-Z03	15°	35	43	20	100	38	3			
HPF15-TC16-D43X52-W20-L100-Z03	15°	43	52	20	100	40	3			
HPF15-TC16-D53X60-W25-L100-Z03	15°	53	60	25	100	40	3			
HPF17.5-TC16-D18X26-W16-L100-Z01	17.5°	18	26	16	100	30	1			
HPF20-TC16-D12X21-W16-L100-Z01	20°	12	21	16	100	30	1			
HPF20-TC16-D18X28-W16-L100-Z01	20°	18	28	16	100	30	1			
HPF20-TC16-D24X34-W20-L100-Z02	20°	24	34	20	100	30	2			
HPF20-TC16-D29X39-W20-L100-Z02	20°	29	39	20	100	35	2			
HPF20-TC16-D36X46-W20-L100-Z03	20°	36	46	20	100	40	3			
HPF20-TC16-D46X56-W25-L100-Z03	20°	46	56	25	100	40	3			
HPF20-TC16-D52X62-W25-L100-Z03	20°	52	62	25	100	40	3			
HPF22.5-TC16-D17X28-W16-L100-Z01	22.5°	17	28	16	100	30	1	TCT1102.	1060-M3.5x9	HTA-T08
HPF25-TC16-D17X30-W16-L100-Z01	25°	17	30	16	100	30	1			
HPF30-TC16-D6X20-W16-L100-Z01	30°	6	20	16	100	30	1			
HPF30-TC16-D18X30-W16-L100-Z01	30°	18	30	16	100	30	1			
HPF30-TC16-D22X37-W16-L100-Z02	30°	22	37	16	100	35	2			
HPF30-TC16-D35X50-W25-L100-Z03	30°	35	50	25	100	40	3			
HPF30-TC16-D45X60-W25-L100-Z03	30°	45	60	25	100	40	3			
HPF45-TC11-D4X15-W16-L100-Z02	45°	4	15	16	100	25	2	TCT16T3.	1060-M3.5x9	HTA-T15
HPF45-TC11-D11X24-W16-L100-Z02	45°	11	24	16	100	25	2			
HPF45-TC16-D5X26-W16-L100-Z01	45°	5	26	16	100	30	1			
HPF45-TC16-D10X31-W20-L100-Z02	45°	10	31	20	100	35	2			
HPF45-TC16-D20X41-W20-L100-Z02	45°	20	41	20	100	40	2	TCT16T3.	1060-M3.5x9	HTA-T15
HPF45-TC16-D32X51-W20-L100-Z02	45°	32	51	20	100	40	2			
HPF55-TC16-D16X40-W20-L100-Z03	55°	16	40	20	100	40	3			
HPF62-TC16-D14X40-W20-L100-Z03	62°	14	40	20	100	40	3	TCT16T3.	1060-M3.5x9	HTA-T15
HPF72-TC16-D14X42-W20-L100-Z03	72°	14	42	20	100	40	3			



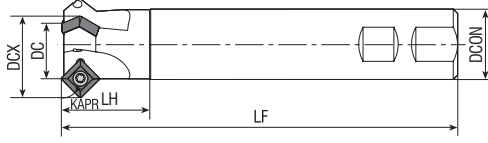

KAPR=45°

Takım Kodu
Ordering Code
Bestell-Bezeichnung

Takım Ölçüleri (mm)
Dimension (mm)
Abmessung (mm)

Kesici Uç
Insert
Wendeschnei
Platte

Sıkma Vidası
Screw
Schraube

Anahtar
Allen Key
Torx Schlüssel

KAPR	DC	DCX	DCON	LF	LH	Z
45°	12	26	20	150	30	1
45°	25	39	25	150	35	2
45°	32	46	32	150	40	3



HPF45-SP.1104-D12x26-W20-L150-Z01
HPF45-SP.1104-D25x39-W25-L150-Z02
HPF45-SP.1104-D32x46-W32-L150-Z03

SP.1104..

1060-M4x9

HTA-T15

Torx Compatible With

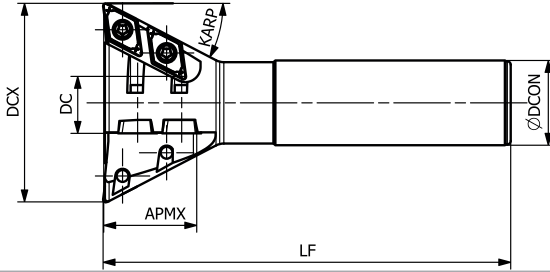

KAPR=-

Takım Kodu
Ordering Code
Bestell-Bezeichnung

Takım Ölçüleri (mm)
Dimension (mm)
Abmessung (mm)

Kesici Uç
Insert
Wendeschnei
Platte

Sıkma Vidası
Screw
Schraube

Anahtar
Allen Key
Torx Schlüssel

KAPR	DC	DCX	DCON	LF	LH	Z
55°	35	55	25	120	35	4
60°	30	60	20	120	10	2
60°	30	60	25	120	10	2
60°	30	60	25	120	20	4
60°	30	60	21	120	30	4

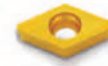

HKFM55 DC11 D60 W25 L120 Z04
HKFM60 DC11 D32 W20 L120 Z02
HKFM60 DC11 D40 W25 L120 Z02
HKFM60 DC11 D50 W25 L120 Z04
HKFM60 DC11 D80 W32 L120 Z04

DCT.11T3..

1060-M3.5x9

HTA-T15

ISO Compatible With

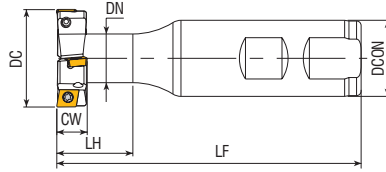
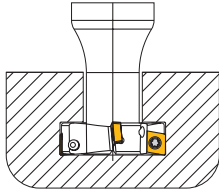

KAPR=90°

Takım Kodu
Ordering Code
Bestell-Bezeichnung

Takım Ölçüleri (mm)
Dimension (mm)
Abmessung (mm)

Kesici Uç
Insert
Wendeschnei
Platte

Sıkma Vidası
Screw
Schraube

Anahtar
Allen Key
Torx Schlüssel

	Z	DC	CW	DCON	LF	DN	LH			
HTF90-CC06-D17X8-W16-L100-Z02	2	17	8	16	100	10	16	CC.. 0602..	1060-M2.5x6	HTA-T08
HTF90-CC06-D22X8-W20-L120-Z04	4	22	8	20	120	14	15.5			
HTF90-CC06-D28X8-W20-L120-Z04	4	28	8	20	120	14	15.5			
HTF90-CC06-D32X8-W25-L120-Z04	4	32	8	25	120	16	23			
HTF90-CC06-D45X8-W25-L120-Z06	6	45	8	25	120	25	30			
HTF90-CC06-D63X8-W32-L120-Z08	8	63	8	32	120	31.5	30			
HTF90-CC06-D22X10-W20-L120-Z04	4	22	10	20	120	12	25			
HTF90-CC06-D25X10-W20-L120-Z04	4	25	10	20	120	12	25			
HTF90-CC06-D32X10-W25-L120-Z04	4	32	10	25	120	16	25			
HTF90-CC06-D45X10-W32-L120-Z06	6	45	10	32	120	20	25			
HTF90-CC06-D25X11-W25-L120-Z04	4	25	11	25	120	13	20	CC.. 09T3..	1060-M3.5x9	HTA-T15
HTF90-CC09-D30X12-W25-L120-Z04	4	30	12	25	120	16	25			
HTF90-CC09-D32X12-W25-L120-Z04	4	32	12	25	120	16	25			
HTF90-CC09-D35X12-W25-L120-Z04	4	35	12	25	120	16	25			
HTF90-CC09-D40X12-W25-L120-Z04	4	40	12	25	120	20	25			
HTF90-CC09-D32X14-W25-L120-Z04	4	32	14	25	120	16	25			
HTF90-CC09-D35X14-W25-L120-Z04	4	35	14	25	120	16	25			
HTF90-CC09-D42X14-W25-L120-Z04	4	42	14	25	120	20	25			
HTF90-CC09-D37X16-W32-L120-Z04	4	37	16	32	120	17	30			
HTF90-CC09-D40X17-W32-L120-Z04	4	40	17	32	120	19	30			
HTF90-CC09-D42X17-W32-L120-Z04	4	42	17	32	120	19	30	CC.. 1204..	1060-M5x11	HTA-T20
HTF90-CC12-D47X20-W32-L120-Z04	4	47	20	32	120	25	45			
HTF90-CC12-D52X21-W32-L120-Z04	4	52	21	32	120	25	45			
HTF90-CC12-D50X22-W32-L120-Z04	4	50	22	32	120	25	45			
HTF90-CC12-D55X22-W32-L120-Z04	4	55	22	32	120	25	45			

ISO Compatible With



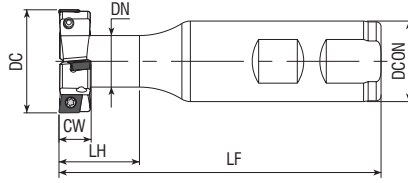
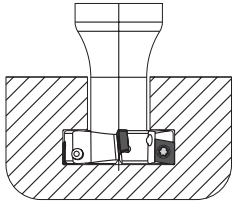

KAPR=90°

Takım Kodu
Ordering Code
Bestell-Bezeichnung

Takım Ölçüleri (mm)
Dimension (mm)
Abmessung (mm)

Kesici Uç
Insert
Wendeschnei
Platte

Sıkma Vidası
Screw
Schraube

Anahtar
Allen Key
Torx Schlüssel

Takım Kodu Ordering Code Bestell-Bezeichnung	Z	DC	CW	DCON	LF	DN	LH	Kesici Uç Insert Wendeschnei Platte	Sıkma Vidası Screw Schraube	Anahtar Allen Key Torx Schlüssel
HTF90-SP.05-D22.5X5-W25-L100-Z04	4	22.5	5	25	100	12	25	SPMG 050204	1060-M2x4	HTA-T06
HTF90-SP.05-D30X5-W25-L100-Z04	4	30	5	25	100	10	25			
HTF90-SP.0904-D32X14-W32-L120-Z04	4	32	14	32	120	18	30			
HTF90-SP.0904-D37X16-W32-L120-Z04	4	37	16	32	120	21	40	SPMG 090408	1060-M3.5x9	HTA-T15
HTF90-SP.0904-D42X17-W32-L120-Z04	4	42	17	32	120	21	40			
HTF90-SP.1104-D47X20-W32-L120-Z04	4	47	20	32	120	24	45	SPMG 110408	1060-M4x11	

TCTC Compatible With

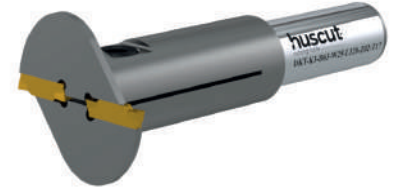
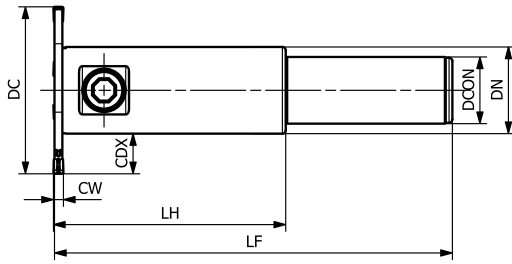

KAPR=-

Takım Kodu
Ordering Code
Bestell-Bezeichnung

Takım Ölçüleri (mm)
Dimension (mm)
Abmessung (mm)

Kesici Uç
Insert
Wendeschnei
Platte

Sıkma Vidası
Screw
Schraube

Anahtar
Allen Key
Torx Schlüssel

Takım Kodu Ordering Code Bestell-Bezeichnung	Z	DC	CW	DCON	LF	DN	LH	Kesici Uç Insert Wendeschnei Platte	Sıkma Vidası Screw Schraube	Anahtar Allen Key Torx Schlüssel
HTF-K-3-D50-W25-L120-Z2	2	50	3	25	120	25	65		HKV-05-M6x25	HAL-05
HTF-K-3-D63-W25-L120-Z2	2	63	3	25	120	28	60	MGM.-3	HKV-06-M8x1x20	HAL-04
HTF-K-3-D80-W32-L120-Z2	2	80	3	32	120	38	55			
HTF-K-4-D50-W25-L120-Z2	2	50	4	25	120	25	65		HKV-05-M6x25	HAL-05
HTF-K-4-D63-W25-L120-Z2	2	63	4	25	120	28	60	MGM.-4	HKV-06-M8x1x20	HAL-04
HTF-K-4-D80-W32-L120-Z2	2	80	4	32	120	38	55			
HTF-K-4-D50-W25-L120-Z2	2	50	5	25	120	25	65		HKV-05-M6x25	HAL-05
HTF-K-4-D63-W25-L120-Z2	2	63	5	25	120	28	60	MGM.-5	HKV-06-M8x1x20	HAL-04
HTF-K-4-D80-W32-L120-Z2	2	80	5	32	120	38	55			



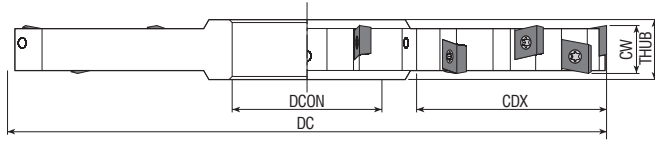

KRTV Compatible With





KAPR=90°



 Takım Kodu Ordering Code Bestell-Bezeichnung	Takım Ölçüleri (mm) Dimension (mm) Abmessung (mm)						Kesici Uç Insert Wendeschnei Platte	Sıkma Vidası Screw Schraube	Anahtar Allen Key Torx Schlüssel			
	Z	DC	CW	CDX	DCON	THUB						
HDFM-CC06-D60x8-d27-Z8	8	60	8	14	22	12	CC..0602..	1060-M2.5x6	HTA-T08			
HDFM-CC06-D80x8-d27-Z10	10	80	8	17	27	12						
HDFM-CC06-D100x8-d32-Z12	12	100	8	25	32	12						
HDFM-CC06-D125x8-d40-Z14	14	125	8	35	40	12						
HDFM-CC06-D160x8-d40-Z16	16	160	8	52	40	12						
HDFM-CC06-D200x8-d40-Z18	18	200	8	70	40	12						
HDFM-CC06-D60x10-d27-Z8	8	60	10	14	22	14						
HDFM-CC06-D80x10-d27-Z10	10	80	10	17	27	14						
HDFM-CC06-D100x10-d32-Z12	12	100	10	25	32	14						
HDFM-CC06-D125x10-d40-Z14	14	125	10	35	40	14						
HDFM-CC06-D160x10-d40-Z16	16	160	10	52	40	14						
HDFM-CC06-D200x10-d40-Z18	18	200	10	70	40	14						
HDFM-CC09-D80x12-d27-Z08	8	80	12	17	27	16	CC..09T3..	1060-M3.5x11	HTA-T15			
HDFM-CC09-D100x12-d32-Z10	10	100	12	25	32	16						
HDFM-CC09-D125x12-d40-Z12	12	125	12	35	40	16						
HDFM-CC09-D160x12-d40-Z14	14	160	12	52	40	16						
HDFM-CC09-D200x12-d40-Z16	16	200	12	70	40	16						
HDFM-CC09-D80x14-d27-Z08	8	80	14	17	27	18						
HDFM-CC09-D100x14-d32-Z10	10	100	14	25	32	18						
HDFM-CC09-D125x14-d40-Z12	12	125	14	35	40	18						
HDFM-CC09-D160x14-d40-Z14	14	160	14	52	40	18						
HDFM-CC09-D200x14-d40-Z16	16	200	14	70	40	18						
HDFM-CC12-D80x16-d27-Z06	6	80	16	17	27	20				CC..1204..	1060-M5x11	HTA-T20
HDFM-CC12-D100x16-d32-Z08	8	100	16	25	32	20						
HDFM-CC12-D125x16-d40-Z10	10	125	16	35	40	20						
HDFM-CC12-D160x16-d40-Z12	12	160	16	52	40	20						
HDFM-CC12-D200x16-d40-Z14	14	200	16	70	40	20						
HDFM-CC12-D80x18-d27-Z06	6	80	18	17	27	22						
HDFM-CC12-D100x18-d32-Z08	8	100	18	25	32	22						
HDFM-CC12-D125x18-d40-Z10	10	125	18	35	40	22						
HDFM-CC12-D160x18-d40-Z12	12	160	18	52	40	22						
HDFM-CC12-D200x18-d40-Z14	14	200	18	70	40	22						
HDFM-CC12-D250x18-d40-Z16	16	250	18	90	40	22						
HDFM-CC12-D80x20-d27-Z06	6	80	20	17	27	24	CC..1204..	1060-M5x11	HTA-T20			
HDFM-CC12-D100x20-d32-Z08	8	100	20	25	32	24						
HDFM-CC12-D125x20-d40-Z10	10	125	20	35	40	24						
HDFM-CC12-D160x20-d40-Z12	12	160	20	52	40	24						
HDFM-CC12-D200x20-d40-Z14	14	200	20	70	40	24						
HDFM-CC12-D250x20-d40-Z16	16	250	20	90	40	24						

ISO Compatible With





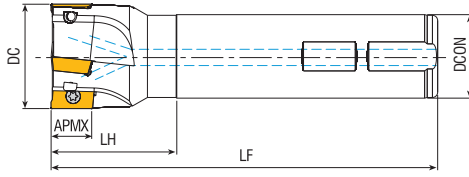

Perfect
Cut





KAPR=90°



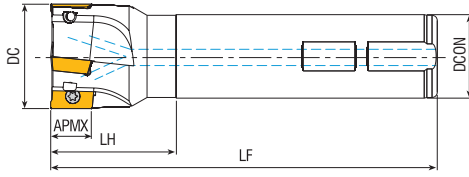

 Takım Kodu Ordering Code Bestell-Bezeichnung	Takım Ölçüleri (mm) Dimension (mm) Abmessung (mm)					Kesici Uç Insert Wendschnei Platte	Sıkma Vidası Screw Schrauble	Anahtar Allen Key Torx Schlüssel
	DC	Z	DCON	LF	LH			
HM90-AP10-D10-C10-L100-Z01	10	1	10	100	20			
HM90-AP10-D12-C16-L100-Z01-H	12	1	16	100	30			
HM90-AP10-D12-W16-L100-Z01-H	12	1	16	100	30			
HM90-AP10-D12-W16-L150-Z01	12	1	16	150	38			
HM90-AP10-D14-W16-L120-Z01-H	14	1	16	100	30			
HM90-AP10-D16-C16-L100-Z02-H	16	2	16	100	30			
HM90-AP10-D16-W16-L100-Z02-H	16	2	16	100	30			
HM90-AP10-D16-W16-L200-Z02	16	2	16	200	100			
HM90-AP10-D16-C16-L120-Z02-H	16	2	16	120	30			
HM90-AP10-D16-C16-L150-Z02-H	16	2	16	150	30			
HM90-AP10-D16-W16-L150-Z02-H	16	2	16	150	30			
HM90-AP10-D16-C16-L200-Z02	16	2	16	200	50			
HM90-AP10-D16-C16-L200-Z02-H	16	2	16	200	50			
HM90-AP10-D17-C16-L150-Z02	17	2	16	150	30			
HM90-AP10-D18-W16-L100-Z02-H	18	2	16	100	30			
HM90-AP10-D18-W16-L150-Z02	18	2	16	150	30			
HM90-AP10-D20-C20-L100-Z03-H	20	3	20	100	30			
HM90-AP10-D20-W20-L100-Z03-H	20	3	20	100	30			
HM90-AP10-D20-C20-L120-Z03-H	20	3	20	120	30			
HM90-AP10-D20-C20-L150-Z03-H	20	3	20	150	50	AP. 1003.	1060-M2.5x6	HTA-T08
HM90-AP10-D20-W20-L150-Z03-H	20	3	20	150	50			
HM90-AP10-D20-C20-L200-Z03	20	3	20	200	50			
HM90-AP10-D20-C20-L200-Z03-H	20	3	20	200	50			
HM90-AP10-D20-C20-L250-Z03	20	3	20	250	100			
HM90-AP10-D21-W20-L150-Z03	21	3	20	150	30			
HM90-AP10-D21-C20-L200-Z03	21	3	20	200	30			
HM90-AP10-D22-W20-L120-Z03-H	22	3	20	120	30			
HM90-AP10-D22-W20-L150-Z03-H	22	3	20	150	30			
HM90-AP10-D22-C20-L200-Z03	22	3	20	200	50			
HM90-AP10-D23-W20-L150-Z03	23	3	20	150	30			
HM90-AP10-D24-W20-L150-Z03	24	3	20	150	30			
HM90-AP10-D25-W25-L100-Z03-H	25	3	25	100	30			
HM90-AP10-D25-C25-L100-Z03-H	25	3	25	100	30			
HM90-AP10-D25-C25-L120-Z03-H	25	3	25	120	30			
HM90-AP10-D25-W25-L150-Z03-H	25	3	25	150	50			
HM90-AP10-D25-C25-L200-Z03	25	3	25	200	100			
HM90-AP10-D25-C25-L250-Z03	25	3	25	250	100			
HM90-AP10-D26-W25-L150-Z03	26	3	25	150	50			
HM90-AP10-D26-C25-L200-Z03	26	3	25	200	100			

Iso Compatible With







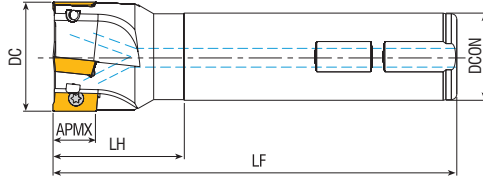

KAPR=90°

 Takım Kodu Ordering Code Bestell-Bezeichnung	Takım Ölçüleri (mm) Dimension (mm) Abmessung (mm)					Kesici Uç Insert Wendschnei Platte	Sıkma Vidası Screw Schraube	Anahtar Allen Key Torx Schlüssel
	DC	Z	DCON	LF	LH			
HM90-AP10-D30-C25-L100-Z04-H	30	4	25	100	30	AP.1003.	1060-M2.5x6	HTA-T08
HM90-AP10-D30-C25-L120-Z04-H	30	4	25	120	30			
HM90-AP10-D30-C25-L150-Z04-H	30	4	25	150	30			
HM90-AP10-D32-W25-L120-Z04-H	32	4	25	120	35			
HM90-AP10-D32-W32-L120-Z04-H	32	4	25	120	35			
HM90-AP10-D32-W25-L150-Z04	32	4	25	150	35			
HM90-AP10-D32-W32-L150-Z04	32	4	32	150	50			
HM90-AP10-D40-W32-L150-Z05	40	5	32	150	40			
HM90-AP16-D25-W25-L120-Z02	25	2	20	120	35	AP.1604.	1060-M4x9	HTA-T15
HM90-AP16-D25-W25-L120-Z02-H	25	2	25	120	35			
HM90-AP16-D25-W25-L150-Z02-H	25	2	25	150	50			
HM90-AP16-D25-C25-L250-Z02	25	2	25	250	100			
HM90-AP16-D26-W25-L120-Z02-H	26	2	25	120	35			
HM90-AP16-D26-W25-L150-Z02-H	26	2	25	150	50			
HM90-AP16-D26-C25-L200-Z02	26	2	25	200	70			
HM90-AP16-D28-W25-L120-Z03-H	28	3	25	120	40			
HM90-AP16-D28-W25-L150-Z03-H	28	3	25	150	40			
HM90-AP16-D28-C25-L200-Z03	28	3	25	200	70			
HM90-AP16-D30-W25-L120-Z03-H	30	3	25	120	40			
HM90-AP16-D30-W25-L150-Z03	30	3	25	150	40			
HM90-AP16-D30-C25-L200-Z03	30	3	25	200	70			
HM90-AP16-D32-W25-L120-Z03	32	3	25	120	40			
HM90-AP16-D32-W32-L120-Z03-H	32	3	32	120	40			
HM90-AP16-D32-C32-L150-Z03	32	3	32	150	50			
HM90-AP16-D32-W25-L150-Z03	32	3	25	150	40			
HM90-AP16-D32-W32-L150-Z03	32	3	32	150	50			
HM90-AP16-D32-W32-L150-Z03-H	32	3	32	150	50			
HM90-AP16-D32-C25-L200-Z03	32	3	25	200	40			
HM90-AP16-D32-C32-L250-Z03	32	3	32	250	100			
HM90-AP16-D35-W32-L150-Z03	35	3	32	150	40			
HM90-AP16-D36-W32-L120-Z03	36	3	32	120	40			
HM90-AP16-D36-W32-L150-Z03	36	3	32	150	40			
HM90-AP16-D40-W32-L120-Z04-H	40	4	32	120	40			
HM90-AP16-D40-C32-L150-Z04	40	4	32	150	40			
HM90-AP16-D40-W32-L150-Z04	40	4	32	150	40			
HM90-AP16-D40-C32-L250-Z04	40	4	32	250	40			

Iso Compatible With





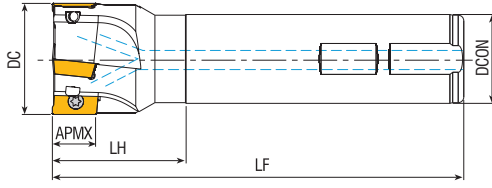

KAPR=90°

 Takım Kodu Ordering Code Bestell-Bezeichnung	Takım Ölçüleri (mm) Dimension (mm) Abmessung (mm)					Kesici Uç Insert Wendeschnei Platte	Sıkma Vidası Screw Schrauble	Anahtar Allen Key Torx Schlüssel
	DC	Z	DCON	LF	LH			
HM90-AP09-D16-C16-L100-Z02-H	16	2	16	100	30	AP. 09T3.	1060-M2.5x6	HTA-T08
HM90-AP09-D16-W16-L150-Z02-H	16	2	16	150	25			
HM90-AP09-D16-C16-L200-Z02	16	2	16	200	100			
HM90-AP09-D17-C16-L120-Z02-H	17	2	16	120	25			
HM90-AP09-D17-C16-L150-Z02	17	2	16	150	25			
HM90-AP09-D20-C20-L150-Z03-H	20	3	20	150	50			
HM90-AP09-D20-C20-L200-Z03	20	3	20	200	100			
HM90-AP09-D21-C20-L150-Z03	21	3	20	150	25			
HM90-AP09-D22-C20-L150-Z03	22	3	20	150	30			
HM90-AP1204-D20-C20-L150-Z02	20	2	20	150	30	AP. 1204.	1070-M3.5x8	HTA-T15
HM90-AP1204-D21-C20-L150-Z02	21	2	20	150	30			
HM90-AP1204-D21-C20-L200-Z02	21	2	20	200	30			
HM90-AP1204-D22-C20-L150-Z02	22	2	20	150	30			
HM90-AP1204-D22-C20-L200-Z02	22	2	20	200	30			
HM90-AP1204-D25-C25-L150-Z03	25	3	25	150	40			
HM90-AP1204-D26-C25-L200-Z03	26	3	25	200	35			
HM90-AP1204-D32-C25-L150-Z04	32	4	25	150	35			
HM90-AP1705-D25-C25-L120-Z02	25	2	25	120	40	AP.1705.	1060-M4x9	HTA-T15
HM90-AP1705-D26-C25-L200-Z02	26	2	25	200	40			
HM90-AP1705-D26-C25-L250-Z02	26	2	25	250	40			
HM90-AP1705-D26-C25-L300-Z02	26	2	25	300	40			
HM90-AP1705-D28-W25-L150-Z02	28	2	25	150	20			
HM90-AP1705-D32-C25-L150-Z03	32	3	25	150	40			
HM90-AP1705-D33-C32-L250-Z03	33	3	32	250	40			
HM90-AP1705-D33-C32-L300-Z03	33	3	32	300	40			

TGTC Compatible With





KAPR=90°

 Takım Kodu Ordering Code Bestell-Bezeichnung	Takım Ölçüleri (mm) Dimension (mm) Abmessung (mm)					Kesici Uç Insert Wendeschnei Platte	Sıkma Vidası Screw Schraube	Anahtar Allen Key Torx Schlüssel
	DC	Z	DCON	LF	LH			
HM90-AP06-D10-C10-L120-Z02	10	2	10	120	20	APMT 0602.	1060-M1.8x4	HTA-T06
HM90-AP06-D12-C12-L120-Z02	12	2	12	120	20			
HM90-AP0903-D12-C16-L100-Z01-H	12	1	16	100	30	APMT 0903.	1060-M2.5x6	HTA-T08
HM90-AP0903-D16-C16-L100-Z02	16	2	16	100	30			
HM90-AP0903-D16-C16-L150-Z02	16	2	16	150	30			
HM90-AP0903-D17-C16-L150-Z02	17	2	16	150	30			
HM90-AP0903-D18-C16-L100-Z02-H	18	2	16	100	30			
HM90-AP0903-D20-C20-L120-Z02	20	2	20	120	30			
HM90-AP0903-D20-C20-L150-Z02	20	2	20	150	30			
HM90-AP0903-D20-C20-L200-Z02	20	2	20	200	100			
HM90-AP0903-D21-C20-L150-Z02	21	2	20	150	30			
HM90-AP0903-D25-C25-L120-Z03	25	3	25	120	30			
HM90-AP0903-D25-C25-L150-Z03	25	3	25	150	30			
HM90-AP0903-D25-C25-L200-Z02	25	2	25	200	100			
HM90-AP11T3-D16-C16-L120-Z02-H	16	2	16	120	30	APMT 11T3.	1060-M2.5x6	HTA-T08
HM90-AP11T3-D16-W16-L150-Z02-H	16	2	16	150	50			
HM90-AP11T3-D17-C16-L150-Z02-H	17	2	16	150	30			
HM90-AP11T3-D17-C16-L200-Z02	17	2	16	200	30			
HM90-AP11T3-D18-W16-L120-Z02-H	18	2	16	120	30			
HM90-AP11T3-D18-W16-L150-Z02-H	18	2	16	150	30			
HM90-AP11T3-D20-C20-L120-Z02-H	20	2	20	120	30			
HM90-AP11T3-D20-W20-L150-Z03-H	20	3	20	150	50			
HM90-AP11T3-D21-C20-L150-Z03-H	21	3	20	150	30			
HM90-AP11T3-D25-W25-L120-Z03-H	25	3	25	150	50			
HM90-AP11T3-D25-W25-L150-Z03-H	25	3	25	150	30			
HM90-AP11T3-D26-W25-L150-Z03-H	26	3	25	150	35			
HM90-AP11T3-D32-W25-L150-Z04-H	32	4	25	150	35			

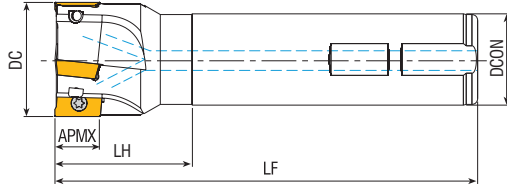
KPR/Compatible With





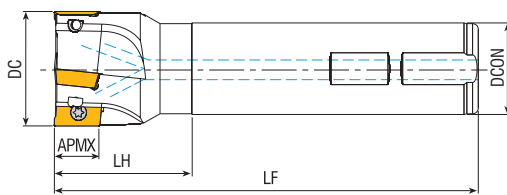

KAPR=90°

 Takım Kodu Ordering Code Bestell-Bezeichnung	Takım Ölçüleri (mm) Dimension (mm) Abmessung (mm)					Kesici Uç Insert Wendschnei-Platte	Sıkma Vidası Screw Schraube	Anahtar Allen Key Torx Schlüssel
	DC	Z	DCON	LF	LH			
HM90-AP1135-D16-C16-L120-Z02-H	16	2	16	120	30	APMT 1135.	1060-M2.5x6	HTA-T08
HM90-AP1135-D16-W16-L150-Z02-H	16	2	16	150	50			
HM90-AP1135-D17-C16-L150-Z02-H	17	2	16	150	30			
HM90-AP1135-D17-C16-L200-Z02	17	2	16	200	30			
HM90-AP1135-D18-W16-L120-Z02-H	18	2	16	120	30			
HM90-AP1135-D18-W16-L150-Z02-H	18	2	16	150	30			
HM90-AP1135-D20-C20-L120-Z02-H	20	2	20	120	30			
HM90-AP1135-D20-W20-L150-Z03-H	20	3	20	150	50			
HM90-AP1135-D21-C20-L150-Z03-H	21	3	20	150	30			
HM90-AP1135-D22-C20-L120-Z03-H	22	3	20	120	30			
HM90-AP1135-D22-C20-L150-Z03-H	22	3	20	150	30			
HM90-AP1135-D25-W25-L120-Z03-H	25	3	25	150	50			
HM90-AP1135-D25-W25-L150-Z03-H	25	3	25	150	30			
HM90-AP1135-D26-W25-L150-Z03-H	26	3	25	150	35			
HM90-AP1135-D32-W25-L150-Z04-H	32	4	25	150	35			

YG Compatible With





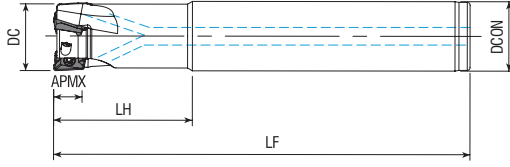

KAPR=90°

 Takım Kodu Ordering Code Bestell-Bezeichnung	Takım Ölçüleri (mm) Dimension (mm) Abmessung (mm)					Kesici Uç Insert Wendschnei-Platte	Sıkma Vidası Screw Schraube	Anahtar Allen Key Torx Schlüssel
	DC	Z	DCON	LF	LH			
HM90-AP11-D16-W16-L150-Z02-H	16	2	16	150	50	AP. 11T3.	1060-M2.5x6	HTA-T08
HM90-AP11-D17-W16-L150-Z02-H	17	2	16	150	30			
HM90-AP11-D18-W16-L150-Z02-H	18	2	16	150	30			
HM90-AP11-D20-W20-L150-Z03-H	20	3	20	150	50			
HM90-AP11-D21-W20-L150-Z03-H	21	3	20	150	30			
HM90-AP11-D25-W25-L150-Z03-H	25	3	25	150	50			
HM90-AP11-D26-W25-L150-Z03-H	26	3	25	150	35			
HM90-AP11-D32-W32-L150-Z04-H	32	4	32	150	50			

ZCC Compatible With





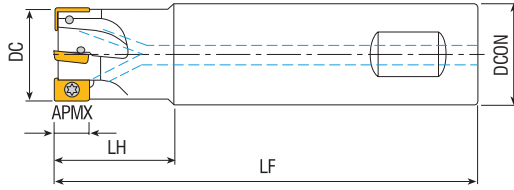

KAPR=90°

 Takım Kodu Ordering Code Bestell-Bezeichnung	Takım Ölçüleri (mm) Dimension (mm) Abmessung (mm)					Kesici Uç Insert Wendeschnei Platte	Sıkma Vidası Screw Schraube	Anahtar Allen Key Torx Schlüssel
	DC	Z	DCON	LF	LH			
HM90-AX1235-D16-C16-L120-Z02-H	16	2	16	120	25	AX.T 1235..	1070-M3x6	HTA-T08
HM90-AX1235-D16-C16-L150-Z02-H	16	2	16	150	30			
HM90-AX1235-D20-C20-L120-Z03-H	20	3	20	120	40			
HM90-AX1235-D20-C20-L150-Z03-H	20	3	20	150	40			
HM90-AX1235-D25-C20-L120-Z04-H	25	4	20	120	30		1070-M3x6.8	
HM90-AX1235-D25-W20-L120-Z04-H	25	4	20	120	30			
HM90-AX1235-D25-C25-L120-Z04-H	25	4	25	120	40			
HM90-AX1235-D25-W25-L120-Z04-H	25	4	25	120	30			
HM90-AX1235-D25-W25-L150-Z04-H	25	4	25	150	30			
HM90-AX1235-D25-C25-L150-Z04-H	25	4	25	150	50			
HM90-AX1235-D32-C32-L150-Z05-H	32	5	32	150	40	AX.T 1705..	1060-M4x9	
HM90-AX1235-D32-W32-L150-Z05-H	32	5	32	150	40			
HM90-AX1705-D25-C25-L150-Z02	25	2	25	150	50			
HM90-AX1705-D25-W25-L150-Z02	25	2	25	150	50			
HM90-AX1705-D28-W25-L150-Z02	28	2	25	150	35			
HM90-AX1705-D32-W32-L120-Z03-H	32	3	32	120	50			
HM90-AX1705-D32-W32-L150-Z03-H	32	3	32	150	50			
HM90-AX1705-D32-C32-L200-Z03	32	2	32	200	50			

SMTM Compatible With



KAPR=90°



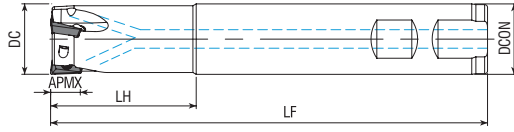

 Takım Kodu Ordering Code Bestell-Bezeichnung	Takım Ölçüleri (mm) Dimension (mm) Abmessung (mm)					Kesici Uç Insert Wendschnei Platte	Sıkma Vidası Screw Schrauble	Anahtar Allen Key Torx Schlüssel
	DC	Z	DCON	LF	LH			
HM90-XO06-D10-C12-L120-Z02	10	2	12	120	50	XO. 0602.	1060-M1.8x4	HTA-T06
HM90-XO06-D12-C12-L120-Z02	12	2	12	120	25			
HM90-XO09-D16-W16-L120-Z02	16	2	16	120	50			
HM90-XO09-D18-W16-L120-Z02	18	2	16	120	50	XO. 0903.	1060-M2.5x5	HTA-T08
HM90-XO09-D20-W20-L120-Z03	20	3	20	120	50			
HM90-XO10-D16-W16-L120-Z02	16	2	16	120	40			
HM90-XO10-D16-W16-L150-Z02	16	2	16	150	40	XO.10T3.	1060-M2.5x5	HTA-T08
HM90-XO10-D18-W16-L120-Z02	18	2	16	120	40			
HM90-XO10-D18-W16-L150-Z02	18	2	16	150	40			
HM90-XO10-D20-W20-L120-Z03	20	3	20	120	40			
HM90-XO10-D20-W20-L150-Z03	20	3	20	150	40			
HM90-XO10-D22-W20-L150-Z03	22	3	20	150	40			
HM90-XO12-D20-W20-L150-Z02	20	2	20	150	50			
HM90-XO12-D20-C20-L200-Z02	20	2	20	200	100	XO. 1204.	1070-M3.5x8	HTA-T15
HM90-XO12-D22-W20-L150-Z02	22	2	20	150	30			
HM90-XO12-D25-W25-L150-Z03	25	3	25	150	50			
HM90-XO12-D25-C25-L200-Z03	25	3	25	200	100			
HM90-XO12-D32-C25-L150-Z04	32	4	25	150	40			
HM90-XO12-D32-W32-L150-Z04	32	4	32	150	50			
HM90-XO12-D32-C32-L250-Z04	32	4	32	250	100			

SCO Compatible With







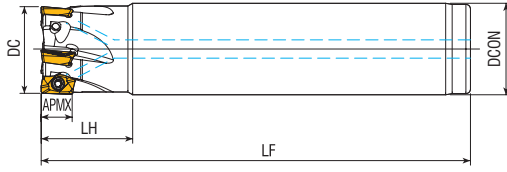

KAPR=90°

 Takım Kodu Ordering Code Bestell-Bezeichnung	Takım Ölçüleri (mm) Dimension (mm) Abmessung (mm)					Kesici Uç Insert Wendeschnel-Platte	Sıkma Vidası Screw Schraube	Anahtar Allen Key Torx Schlüssel
	DC	Z	DCON	LF	LH			
HM90-AD0803-D16-W16-L150-Z02	16	2	16	150	30	ADMT 0803.	1060-M2.5x6	HTA-T08
HM90-AD0803-D17-W16-L150-Z02	17	2	16	150	30			
HM90-AD0803-D20-W20-L150-Z03	20	3	20	150	30			
HM90-AD0803-D21-W20-L200-Z03	21	3	20	200	30			
HM90-AD10T3-D16-W16-L100-Z02-H	16	2	16	100	30	ADMT 10T3.	1060-M2.5x6	HTA-T08
HM90-AD10T3-D16-W16-L150-Z02	16	2	16	150	40			
HM90-AD10T3-D16-C16-L200-Z02	16	2	16	200	50			
HM90-AD10T3-D17-W16-L150-Z02	17	2	16	150	30			
HM90-AD10T3-D17-W16-L200-Z02	17	2	16	200	30			
HM90-AD10T3-D20-W20-L100-Z03-H	20	3	20	100	30			
HM90-AD10T3-D20-C20-L150-Z03	20	3	20	150	40			
HM90-AD10T3-D20-C20-L200-Z03	20	3	20	200	50			
HM90-AD10T3-D25-W25-L100-Z04-H	25	4	25	100	30			
HM90-AD10T3-D25-W25-L150-Z04	25	4	25	150	50			
HM90-AD1204-D20-W20-L150-Z02	20	2	20	150	50	ADMT 1204.	1060-M3x6	HTA-T08
HM90-AD1204-D22-C20-L150-Z02	22	2	20	150	30			
HM90-AD1204-D25-W25-L150-Z03	25	3	25	150	50			
HM90-AD1204-D26-W25-L150-Z03	26	3	25	150	30			
HM90-AD1204-D32-W32-L150-Z04	32	4	32	150	50			
HM90-AD1606-D25-W25-L150-Z02	25	2	25	150	50	ADMT 1606.	1060-M4x9	HTA-T15
HM90-AD1606-D32-W32-L150-Z03	32	3	32	150	50			

WLTB Compatible With



KAPR=90°

 Takım Kodu Ordering Code Bestell-Bezeichnung	Takım Ölçüleri (mm) Dimension (mm) Abmessung (mm)					Kesici Uç Insert Wendschnei Platte	Sıkma Vidası Screw Schraube	Anahtar Allen Key Torx Schlüssel
	DC	Z	DCON	LF	LH			
HM90-AD07-D10-C10-L100-Z02-H	10	2	10	100	15	ADMX 0702.	1060-M2x4	HTA-T06
HM90-AD07-D12-C12-L100-Z03-H	12	3	12	100	20			
HM90-AD07-D16-C16-L120-Z04-H	16	4	16	120	20			
HM90-AD07-D20-C20-L120-Z05-H	20	5	20	120	20			
HM90-AD07-D25-C25-L150-Z06-H	25	6	25	150	25			
HM90-AD11-D16-C16-L150-Z02-H	16	2	16	150	30	ADMX 11T30.	1060-M2.5x6	HTA-T08
HM90-AD11-D18-C16-L150-Z02-H	18	2	16	150	30			
HM90-AD11-D20-C20-L150-Z03-H	20	3	20	150	30			
HM90-AD11-D22-C20-L150-Z03-H	22	3	20	150	30			
HM90-AD11-D25-C25-L150-Z03-H	25	3	25	150	30			
HM90-AD11-D28-C25-L150-Z04-H	28	4	25	150	30			
HM90-AD11-D30-C25-L150-Z04-H	30	4	25	150	30			
HM90-AD11-D32-C25-L150-Z04-H	32	4	25	150	30			
HM90-AD16-D25-C25-L150-Z02-H	25	2	25	150	40	ADMX 1606.	1060-M4x9	HTA-T15
HM90-AD16-D28-C25-L150-Z02-H	28	2	25	150	40			
HM90-AD16-D32-C25-L150-Z02-H	32	2	25	150	40			

PMT Compatible With

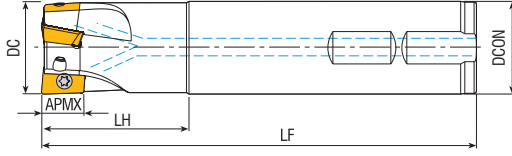

KAPR=90°

 Takım Kodu Ordering Code Bestell-Bezeichnung	Takım Ölçüleri (mm) Dimension (mm) Abmessung (mm)					Kesici Uç Insert Wendschnei Platte	Sıkma Vidası Screw Schraube	Anahtar Allen Key Torx Schlüssel
	DC	Z	DCON	LF	LH			
HM90-AX0602-D10-C10-L120-Z02	10	2	10	120	20	AX.. 0602..	1060-M1.8x4	HTA-T06
HM90-AX0602-D12-C12-L120-Z02	12	2	12	120	20			
HM90-AX0602-D14-C12-L120-Z03	14	3	12	120	20			
HM90-AX0602-D16-W16-L120-Z04-H	16	4	16	120	20			
HM90-AX0602-D16-W16-L150-Z04-H	16	4	16	150	20			
HM90-AX0602-D20-W20-L120-Z05-H	20	5	20	120	25			
HM90-AX0602-D20-W20-L150-Z05-H	20	5	20	150	25	AX.. 0903..	1060-M2.5x5	HTA-T08
HM90-AX0903-D16-C16-L120-Z02	16	2	16	120	30			
HM90-AX0903-D16-C16-L150-Z02	16	2	16	150	30			
HM90-AX0903-D17-C16-L120-Z02	17	2	16	120	25			
HM90-AX0903-D17-C16-L150-Z02	17	2	16	150	25			
HM90-AX0903-D20-C20-L120-Z03	20	3	20	120	30			
HM90-AX0903-D20-C20-L150-Z03	20	3	20	150	30	1060-M2.5x6	HTA-T08	
HM90-AX0903-D21-C20-L120-Z03	21	3	20	120	25			
HM90-AX0903-D21-C20-L150-Z03	21	3	20	150	25			
HM90-AX0903-D25-C25-L150-Z03	25	3	25	150	30			
HM90-AX0903-D25-C25-L200-Z02	25	2	25	200	40			
HM90-AX0903-D26-C25-L150-Z03	26	3	25	150	30			

TCTC Compatible With



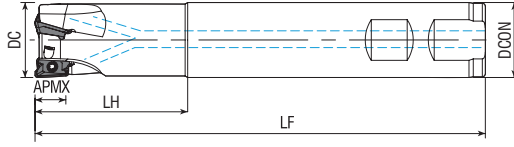



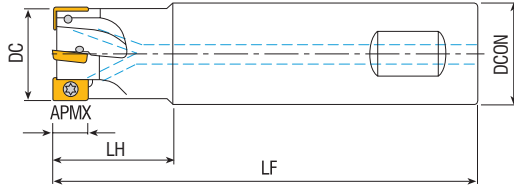

KAPR=90°

 Takım Kodu Ordering Code Bestell-Bezeichnung	Takım Ölçüleri (mm) Dimension (mm) Abmessung (mm)					Kesici Uç Insert Wendschnei Platte	Sıkma Vidası Screw Schrauble	Anahtar Allen Key Torx Schlüssel
	DC	Z	DCON	LF	LH			
HM90-AO12-D16-W16-L150-Z02-H	16	2	16	150	40	AO.1236	1060-M2.5x6	HTA-T08
HM90-AO12-D17-W16-L150-Z02-H	17	2	16	150	40			
HM90-AO12-D18-W16-L150-Z02-H	18	2	16	150	40			
HM90-AO12-D20-C20-L150-Z03-H	20	3	20	150	40			
HM90-AO12-D25-W25-L150-Z03-H	25	3	25	150	40			
HM90-AO12-D26-W25-L150-Z03-H	26	3	25	150	40			
HM90-AO12-D32-W32-L150-Z05-H	32	4	32	150	40			

MTSBH Compatible With





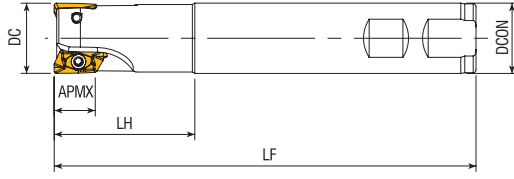

KAPR=90°

 Takım Kodu Ordering Code Bestell-Bezeichnung	Takım Ölçüleri (mm) Dimension (mm) Abmessung (mm)					Kesici Uç Insert Wendschnei Platte	Sıkma Vidası Screw Schrauble	Anahtar Allen Key Torx Schlüssel
	DC	Z	DCON	LF	LH			
HM90-XD0703-D12-C12-L120-Z02	12	2	12	120	30	XD.T 0703..	1060-M2.2x5	HTA-T06
HM90-XD0703-D14-C12-L120-Z02	14	2	12	120	30			
HM90-XD0703-D16-W16-L150-Z03-H	16	3	16	150	30			
HM90-XD0703-D17-W16-L150-Z03-H	17	3	16	150	30			
HM90-XD11T3-D16-W16-L150-Z02-H	16	2	16	150	30	XD.T 11T3..	1060-M2.5x6	HTA-T08
HM90-XD11T3-D17-C16-L150-Z02-H	17	2	16	150	30			
HM90-XD11T3-D20-W20-L150-Z03-H	20	3	20	150	50			
HM90-XD11T3-D21-C20-L150-Z03-H	21	3	20	150	30			
HM90-XD11T3-D25-W25-L150-Z03-H	25	3	25	150	50			
HM90-XD11T3-D26-W25-L150-Z03-H	26	3	25	150	50			
HM90-XD11T3-D30-W25-L150-Z04	30	4	25	150	30			
HM90-XD11T3-D32-W32-L150-Z04	32	4	32	150	50			

CRIZ Compatible With





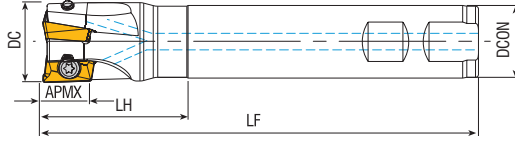

KAPR=90°

 Takım Kodu Ordering Code Bestell-Bezeichnung	Takım Ölçüleri (mm) Dimension (mm) Abmessung (mm)					Kesici Uç Insert Wendeschnei Platte	Sıkma Vidası Screw Schraube	Anahtar Allen Key Torx Schlüssel
	DC	Z	DCON	LF	LH			
HM90-ED10-D16-W16-L120-Z02	16	2	16	120	30	EDPT10T3..	1060-M2.5x5	HTA-T08
HM90-ED10-D16-W16-L150-Z02	16	2	16	150	30			
HM90-ED10-D20-W20-L120-Z02	20	2	20	120	30			
HM90-ED10-D20-W20-L150-Z02	20	2	20	150	30	EDPT1404..	1060-M3x6	HTA-T08
HM90-ED14-D20-W20-L150-Z02	20	2	20	150	50			
HM90-ED14-D25-W25-L150-Z02	25	2	25	150	50			
HM90-ED14-D30-C25-L150-Z03	30	3	25	150	50			
HM90-ED14-D32-W25-L150-Z03	30	3	25	150	50			

KMTL Compatible With



KAPR=90°



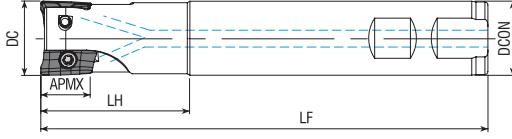

 Takım Kodu Ordering Code Bestell-Bezeichnung	Takım Ölçüleri (mm) Dimension (mm) Abmessung (mm)					Kesici Uç Insert Wendeschnei Platte	Sıkma Vidası Screw Schraube	Anahtar Allen Key Torx Schlüssel
	DC	Z	DCON	LF	LH			
HM90-R390.07-D10-W10-L100-Z02-H	10	2	10	100	25	R390-0702..	1060-M1.8x4	HTA-T06
HM90-R390.07-D12-W12-L100-Z02-H	12	2	12	100	25			
HM90-R390.07-D14-W12-L100-Z03-H	14	3	12	100	25			
HM90-R390.07-D16-W16-L120-Z04-H	16	4	16	120	30			
HM90-R390.11-D16-W16-L100-Z02-H	16	2	16	100	30			
HM90-R390.11-D16-W16-L150-Z02-H	16	2	16	150	50			
HM90-R390.11-D16-W16-L150-Z02	16	2	16	150	50	R390-11T3..	1060-M2.5x5	HTA-T08
HM90-R390.11-D20-W20-L100-Z03-H	20	3	20	100	30			
HM90-R390.11-D20-W20-L150-Z03	20	3	20	150	50			
HM90-R390.11-D20-W20-L150-Z03-H	20	3	20	150	50			
HM90-R390.11-D22-W20-L150-Z03-H	22	3	20	150	30			
HM90-R390.11-D25-W25-L100-Z03-H	25	3	25	100	30			
HM90-R390.11-D25-W25-L150-Z03-H	25	3	25	150	50			
HM90-R390.11-D25-W25-L150-Z03	25	3	25	150	50			
HM90-R390.11-D25-W25-L150-Z02-H	25	2	25	150	50			
HM90-R390.11-D25-W25-L150-Z02	25	2	25	150	50			
HM90-R390.11-D30-W25-L150-Z04-H	30	4	25	150	30			
HM90-R390.11-D32-C25-L200-Z03	32	3	25	200	40			
HM90-R390.11-D32-W32-L150-Z05-H	32	5	32	150	50			
HM90-R390.17-D25-W25-L150-Z02	25	2	25	150	50			
HM90-R390.17-D25-W25-L150-Z02-H	25	2	25	150	50			
HM90-R390.17-D30-W25-L150-Z03	30	3	25	150	40			
HM90-R390.17-D30-W25-L150-Z03-H	30	3	25	150	40			
HM90-R390.17-D32-W32-L150-Z03	32	3	32	150	40			
HM90-R390.17-D32-W32-L150-Z03-H	32	3	32	150	40			
HM90-R390.18-D32-C32-L150-Z03	32	3	32	150	45	R390-1806..	1060-M4x11	HTA-T15
HM90-R390.18-D40-C32-L150-Z03-H	40	3	32	150	45			

SN/PC Compatible With







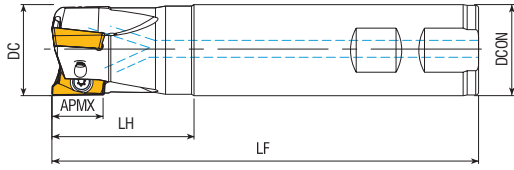

KAPR=90°

 Takım Kodu Ordering Code Bestell-Bezeichnung	Takım Ölçüleri (mm) Dimension (mm) Abmessung (mm)					Kesici Uç Insert Wendeschnei Platte	Sıkma Vidası Screw Schraube	Anahtar Allen Key Torx Schlüssel
	DC	Z	DCON	LF	LH			
HM90-BD07-D10-C10-L100-Z01	10	1	10	100	20	BDMT 0703.	1060-M2x4	HTA-T06
HM90-BD07-D12-C12-L120-Z02	12	2	12	120	25			
HM90-BD11T3-D16-C16-L100-Z02-H	16	2	16	100	30			
HM90-BD11T3-D16-W16-L100-Z02-H	16	2	16	100	30			
HM90-BD11T3-D16-W16-L150-Z02-H	16	2	16	150	50			
HM90-BD11T3-D16-C16-L150-Z02-H	16	2	16	150	50			
HM90-BD11T3-D17-W16-L150-Z02-H	17	2	16	150	25			
HM90-BD11T3-D17-C16-L150-Z02-H	17	2	16	150	25			
HM90-BD11T3-D18-W16-L120-Z02-H	18	2	16	120	25			
HM90-BD11T3-D18-C16-L120-Z02-H	18	2	16	120	25			
HM90-BD11T3-D20-W20-L100-Z03-H	20	3	20	100	30	BDMT 11T3.	1060-M2.5x6	HTA-T08
HM90-BD11T3-D20-W20-L150-Z03-H	20	3	20	150	50			
HM90-BD11T3-D21-W20-L150-Z03	21	3	20	150	25			
HM90-BD11T3-D21-C20-L200-Z02	21	2	20	200	25			
HM90-BD11T3-D22-W20-L150-Z03	22	3	20	150	25			
HM90-BD11T3-D25-W25-L100-Z03-H	25	3	25	100	30			
HM90-BD11T3-D25-C20-L120-Z03-H	25	3	20	120	30			
HM90-BD11T3-D25-C25-L120-Z03-H	25	3	25	120	30			
HM90-BD11T3-D25-W25-L150-Z03-H	25	3	25	150	50			
HM90-BD11T3-D26-W25-L150-Z03	26	3	25	150	35			
HM90-BD11T3-D26-C25-L200-Z02	26	2	25	200	35	BDMT 1704.	1060-M4x9	HTA-T15
HM90-BD11T3-D32-W32-L150-Z04-H	32	4	32	150	50			
HM90-BD11T3-D40-W32-L150-Z04-H	40	4	32	150	35			
HM90-BD1704-D25-W25-L100-Z02-H	25	2	25	100	35			
HM90-BD1704-D25-W25-L150-Z02-H	25	2	25	150	50			
HM90-BD1704-D25-C25-L200-Z02	25	2	25	200	100			
HM90-BD1704-D32-W32-L150-Z03	32	3	32	150	50			
HM90-BD1704-D40-W32-L150-Z04	40	4	32	150	40			

KYCR Compatible With





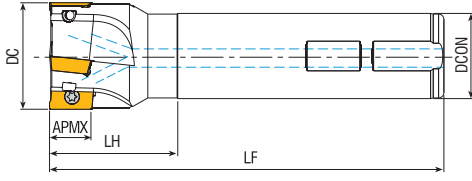

KAPR=90°

 Takım Kodu Ordering Code Bestell-Bezeichnung	Takım Ölçüleri (mm) Dimension (mm) Abmessung (mm)					Kesici Uç Insert Wendeschnei Platte	Sıkma Vidası Screw Schraube	Anahtar Allen Key Torx Schlüssel
	DC	Z	DCON	LF	LH			
HM90-RT07-D10-W10-L120-Z02	10	2	10	120	30	RT 0702	1060-M2x4	HTA-T06
HM90-RT07-D12-C12-L120-Z02	12	2	12	120	30			
HM90-RT07-D12-W12-L120-Z02	12	2	12	120	30			
HM90-RT07-D14-W12-L120-Z02	14	2	12	120	30			
HM90-RT10-D16-W16-L120-Z02-H	16	2	16	120	30			
HM90-RT10-D16-W16-L150-Z02	16	2	16	150	30			
HM90-RT10-D16-C16-L200-Z02	16	2	16	200	100			
HM90-RT10-D17-W16-L150-Z02	17	2	16	150	30			
HM90-RT10-D17-C16-L200-Z02	17	2	16	200	30			
HM90-RT10-D18-W16-L120-Z02-H	18	2	16	120	30			
HM90-RT10-D20-C20-L120-Z03	20	3	20	120	30	RT 1003	1060-M2.5x6	HTA-T08
HM90-RT10-D20-W20-L120-Z03-H	20	3	20	120	30			
HM90-RT10-D20-W20-L150-Z03	20	3	20	150	50			
HM90-RT10-D20-C20-L200-Z03	20	3	20	200	100			
HM90-RT10-D21-W20-L200-Z03	21	3	20	200	30			
HM90-RT10-D22-W20-L120-Z03-H	22	3	20	120	30			
HM90-RT10-D22-C20-L150-Z03	22	3	20	150	30			
HM90-RT10-D22-C20-L200-Z03	22	3	20	200	30			
HM90-RT10-D25-W25-L120-Z04-H	25	4	25	120	40			
HM90-RT10-D25-W25-L150-Z04	25	4	25	150	50			
HM90-RT10-D25-C25-L200-Z04	25	4	25	200	100	RT 1606	1060-M4x9	HTA-T15
HM90-RT10-D32-W32-L120-Z05-H	32	5	32	120	50			
HM90-RT10-D32-W32-L150-Z05	32	5	32	150	50			
HM90-RT10-D32-C32-L200-Z05	32	5	32	200	100			
HM90-RT16-D25-W25-L120-Z02-H	25	2	25	120	40			
HM90-RT16-D25-W25-L150-Z02	25	2	25	150	50			
HM90-RT16-D25-C25-L200-Z02	25	2	25	200	100			
HM90-RT16-D32-W32-L120-Z03-H	32	3	32	120	50			
HM90-RT16-D32-W32-L150-Z03	32	3	32	150	50			
HM90-RT16-D32-C32-L200-Z03	32	3	32	200	100			
HM90-RT16-D32-C32-L250-Z03	32	3	32	250	100			
HM90-RT16-D40-W32-L120-Z04-H	40	4	32	120	50			
HM90-RT16-D40-W32-L150-Z04	40	4	32	150	50			
HM90-RT16-D40-C32-L200-Z04	40	4	32	200	100			

SFTY Compatible With





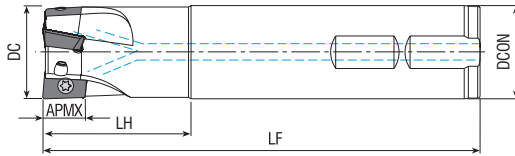

KAPR=90°

 Takım Kodu Ordering Code Bestell-Bezeichnung	Takım Ölçüleri (mm) Dimension (mm) Abmessung (mm)					Kesici Uç Insert Wändeschnei Platte	Sıkma Vidası Screw Schraube	Anahtar Allen Key Torx Schlüssel
	DC	Z	DCON	LF	LH			
HM90-AS11-D16-W16-L150-Z02-H	16	2	16	150	40	AST11T3.	1060-M2.5x6	HTA-T08
HM90-AS11-D18-W16-L150-Z02-H	18	2	16	150	40			
HM90-AS11-D20-W20-L150-Z03-H	20	3	20	150	40			
HM90-AS11-D22-W20-L150-Z03-H	22	3	20	150	40			
HM90-AS11-D25-W25-L150-Z04-H	25	4	25	150	40			
HM90-AS11-D28-W25-L150-Z04-H	28	4	25	150	40			
HM90-AS11-D32-W32-L150-Z05-H	32	5	32	150	40			

ISO88 Compatible With





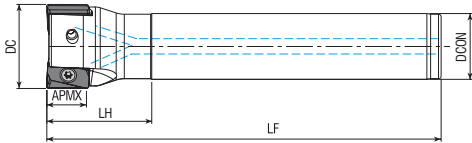

KAPR=90°

 Takım Kodu Ordering Code Bestell-Bezeichnung	Takım Ölçüleri (mm) Dimension (mm) Abmessung (mm)					Kesici Uç Insert Wändeschnei Platte	Sıkma Vidası Screw Schraube	Anahtar Allen Key Torx Schlüssel
	DC	Z	DCON	LF	LH			
HM90-AD1505-D25-W25-L150-Z02-H	25	2	25	150	50	AD.1505.	1060-M4x9	HTA-T15
HM90-AD1505-D30-W25-L150-Z03-H	30	3	25	150	40			
HM90-AD1505-D32-W32-L150-Z03-H	32	3	32	150	50			

ISO88 Compatible With



KAPR=90°

 Takım Kodu Ordering Code Bestell-Bezeichnung	Takım Ölçüleri (mm) Dimension (mm) Abmessung (mm)					Kesici Uç Insert Wändeschnei Platte	Sıkma Vidası Screw Schraube	Anahtar Allen Key Torx Schlüssel
	DC	Z	DCON	LF	LH			
HM90-AN09-D16-W16-L150-Z02-H	16	2	16	150	40	AN.X 0904.	1070-M3x6.8	HTA-T08
HM90-AN09-D20-W20-L150-Z03-H	20	3	20	150	40			
HM90-AN09-D25-W25-L150-Z04-H	25	4	25	150	40			
HM90-AN09-D32-W32-L150-Z05-H	32	5	32	150	40			

ISO88 Compatible With

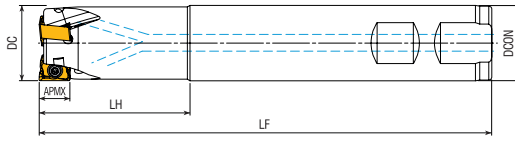

KAPR=90°

 Takım Kodu Ordering Code Bestell-Bezeichnung	Takım Ölçüleri (mm) Dimension (mm) Abmessung (mm)					Kesici Uç Insert Wendeschnel-Platte	Sıkma Vidası Screw Schraube	Anahtar Allen Key Torx Schlüssel
	DC	Z	DCON	LF	LH			
HM90-LN1006-D16-W16-L120-Z01-H	16	1	16	120	30	LN.X 1006.	1060-M3x8	HTA-T08
HM90-LN1006-D16-W16-L150-Z01	16	1	16	150	50			
HM90-LN1006-D18-W16-L120-Z02-H	18	2	16	120	30			
HM90-LN1006-D20-W20-L120-Z02-H	20	2	20	120	30			
HM90-LN1006-D20-W20-L150-Z02-H	20	2	20	150	50			
HM90-LN1006-D22-W20-L150-Z02-H	22	2	20	150	50			
HM90-LN1006-D25-W25-L150-Z03-H	25	3	25	150	50			
HM90-LN1006-D32-W32-L150-Z04-H	32	4	32	150	50			
HM90-LN1006-D40-W32-L150-Z05-H	40	5	32	150	50	LN.X 1510.	1060-M4x12	HTA-T15
HM90-LN1510-D32-W32-L150-Z02-H	32	2	32	150	50			
HM90-LN1510-D35-W32-L150-Z02-H	35	2	32	150	50			
HM90-LN1510-D40-W32-L150-Z02-H	40	2	32	150	50			

KR1X Compatible With

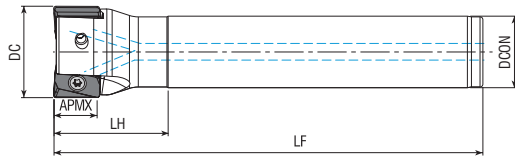



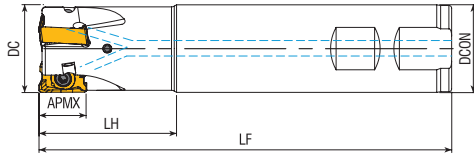

KAPR=90°

 Takım Kodu Ordering Code Bestell-Bezeichnung	Takım Ölçüleri (mm) Dimension (mm) Abmessung (mm)					Kesici Uç Insert Wendeschnel-Platte	Sıkma Vidası Screw Schraube	Anahtar Allen Key Torx Schlüssel
	DC	Z	DCON	LF	LH			
HM90-AN11-D22-W20-L150-Z02-H	22	2	20	150	30	ANGX 1105.	1060-M3x8	HTA-T08
HM90-AN11-D25-W25-L150-Z02-H	25	2	25	150	40			
HM90-AN11-D26-W25-L150-Z02-H	26	2	25	150	40			
HM90-AN11-D28-W25-L150-Z02-H	28	2	25	150	25			
HM90-AN11-D32-W32-L150-Z03-H	32	3	32	150	50			
HM90-AN11-D40-W32-L150-Z04-H	40	4	32	150	40			

Z0C Compatible With





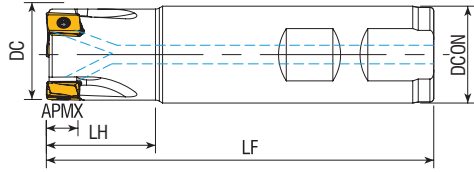

KAPR=90°

 Takım Kodu Ordering Code Bestell-Bezeichnung	Takım Ölçüleri (mm) Dimension (mm) Abmessung (mm)					Kesici Uç Insert Wendeschei Platte	Sıkma Vidası Screw Schraube	Anahtar Allen Key Torx Schlüssel
	DC	Z	DCON	LF	LH			
HM90-LN15T6-D25-W25-L150-Z02-H	25	2	25	150	50	LNGU15T6..	1060-M4x12	HTA-T15
HM90-LN15T6-D32-W32-L150-Z03-H	32	3	32	150	50			
HM90-LN15T6-D36-W32-L150-Z03-H	36	3	32	150	50			
HM90-LN15T6-D40-W32-L150-Z03-H	40	3	32	150	40			

KMTT Compatible With





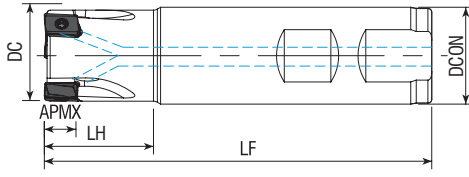

KAPR=90°

 Takım Kodu Ordering Code Bestell-Bezeichnung	Takım Ölçüleri (mm) Dimension (mm) Abmessung (mm)					Kesici Uç Insert Wendeschei Platte	Sıkma Vidası Screw Schraube	Anahtar Allen Key Torx Schlüssel
	DC	Z	DCON	LF	LH			
HM90-LN08-D16-W16-L100-Z02-H	16	2	16	100	28	LNMT 0804..	1060-M2.5x6	HTA-T08
HM90-LN08-D16-W16-L150-Z02-H	16	2	16	150	40			
HM90-LN08-D20-W20-L100-Z03-H	20	3	20	100	28			
HM90-LN08-D20-W20-L150-Z03-H	20	3	20	150	40			
HM90-LN08-D25-W25-L100-Z04-H	25	4	25	100	30			
HM90-LN08-D25-W25-L150-Z04-H	25	4	25	150	40			
HM90-LN08-D32-W32-L150-Z05-H	32	5	32	150	40	T490 LNMT1106..	1060-M3.5x9	HTA-T15
HM90-LN1106-D25-W25-L150-Z03-H	25	3	25	150	40			
HM90-LN1106-D32-W32-L150-Z04-H	32	4	32	150	40			
HM90-LN1106-D40-W32-L150-Z05-H	40	5	32	150	40	LNMT 1306..	1060-M3.5x12	HTA-T15
HM90-LN1306-D32-W32-L150-Z03-H	32	3	32	150	40			
HM90-LN1306-D36-W32-L150-Z03-H	36	3	32	150	40			
HM90-LN1306-D40-W32-L150-Z04-H	40	4	32	150	40			

ISCR Compatible With





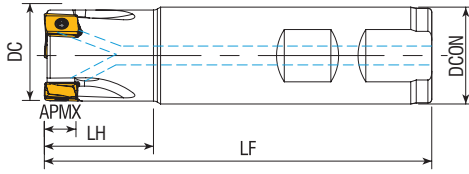

KAPR=90°

 Takım Kodu Ordering Code Bestell-Bezeichnung	Takım Ölçüleri (mm) Dimension (mm) Abmessung (mm)					Kesici Uç Insert Wendeschnei Platte	Sıkma Vidası Screw Schraube	Anahtar Allen Key Torx Schlüssel
	DC	Z	DCON	LF	LH			
HM90-LX08-D16-W16-L150-Z02-H	16	2	16	150	40	LOEX 0804..	1060-M2.5x6	HTA-T08
HM90-LX08-D20-W20-L150-Z03-H	20	3	20	150	40			
HM90-LX08-D25-W25-L150-Z04-H	25	4	25	150	40			
HM90-LX08-D32-W32-L150-Z05-H	32	5	32	150	40			

SCD Compatible With



KAPR=90°



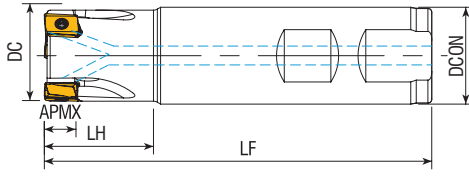

 Takım Kodu Ordering Code Bestell-Bezeichnung	Takım Ölçüleri (mm) Dimension (mm) Abmessung (mm)					Kesici Uç Insert Wendeschnei Platte	Sıkma Vidası Screw Schraube	Anahtar Allen Key Torx Schlüssel
	DC	Z	DCON	LF	LH			
HM90-LO09-D16-C16-L150-Z02-H	16	2	16	150	50	LOGU 0904..	1060-M2.5x6	HTA-T08
HM90-LO09-D18-C16-L150-Z02-H	18	2	16	150	20			
HM90-LO09-D20-W20-L150-Z03-H	20	3	20	150	50			
HM90-LO09-D22-W20-L150-Z03-H	22	3	20	150	50			
HM90-LO09-D25-W25-L150-Z04-H	25	4	25	150	50			
HM90-LO09-D32-W32-L150-Z05-H	32	5	32	150	50			

MTSBH Compatible With



KAPR=90°





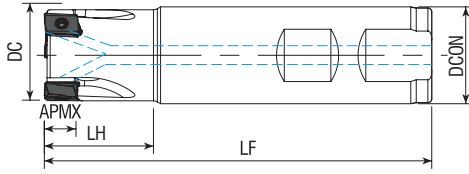

 Takım Kodu Ordering Code Bestell-Bezeichnung	Takım Ölçüleri (mm) Dimension (mm) Abmessung (mm)					Kesici Uç Insert Wendeschnelplatte	Sıkma Vidası Screw Schraube	Anahtar Allen Key Torx Schlüssel
	DC	Z	DCON	LF	LH			
HM90-LP09-D20-W20-L150-Z03-H	20	3	20	150	40			
HM90-LP09-D25-W25-L150-Z04-H	25	3	25	150	40	LPJ 0904..	1060-M3x8	HTA-T08
HM90-LP09-D32-W32-L150-Z05-H	32	5	32	150	40			

T09C Compatible With



KAPR=90°





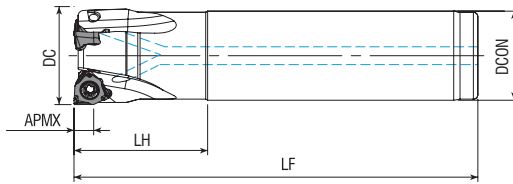

 Takım Kodu Ordering Code Bestell-Bezeichnung	Takım Ölçüleri (mm) Dimension (mm) Abmessung (mm)					Kesici Uç Insert Wendeschnelplatte	Sıkma Vidası Screw Schraube	Anahtar Allen Key Torx Schlüssel
	DC	Z	DCON	LF	LH			
HM90-LH09-D20-W20-L150-Z03-H	20	3	20	150	40			
HM90-LH09-D25-W25-L150-Z04-H	25	3	25	150	40	LNHU 0904..	1060-M3x6	HTA-T08
HM90-LH09-D32-W32-L150-Z05-H	32	5	32	150	40			

W17S Compatible With



KAPR=90°



 Takım Kodu Ordering Code Bestell-Bezeichnung	Takım Ölçüleri (mm) Dimension (mm) Abmessung (mm)					Kesici Uç Insert Wendeschnelplatte	Sıkma Vidası Screw Schraube	Anahtar Allen Key Torx Schlüssel
	DC	Z	DCON	LF	LH			
HM90-XN0403-D16-W16-L150-Z01-H	16	1	16	150	30			
HM90-XN0403-D17-W16-L150-Z02-H	17	2	16	150	30			
HM90-XN0403-D20-W20-L150-Z03-H	20	3	20	150	30			
HM90-XN0403-D21-W20-L150-Z03-H	21	3	20	150	30			
HM90-XN0403-D22-W20-L150-Z03-H	22	3	20	150	30			
HM90-XN0403-D25-W25-L150-Z04-H	25	4	25	150	30			
HM90-XN0403-D26-W25-L150-Z04-H	26	4	25	150	30			
HM90-XN0403-D32-W32-L150-Z05-H	32	5	32	150	30			
HM90-XN0403-D33-W32-L150-Z05-H	33	5	32	150	30			

S00C Compatible With

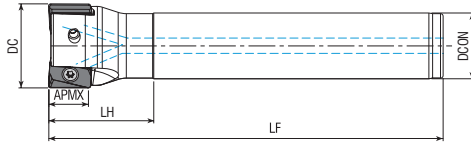

KAPR=90°

 Takım Kodu Ordering Code Bestell-Bezeichnung	Takım Ölçüleri (mm) Dimension (mm) Abmessung (mm)					Kesici Uç Insert Wendeschnei Platte	Sıkma Vidası Screw Schrauble	Anahtar Allen Key Torx Schlüssel
	DC	Z	DCON	LF	LH			
HM90-LM10-D16-W16-L120-Z02-H	16	2	16	120	30	LOMU1004.	1070-M3x6	HTA-T08
HM90-LM10-D16-W16-L150-Z02-H	16	2	16	150	40			
HM90-LM10-D18-W16-L120-Z02-H	18	2	16	120	30			
HM90-LM10-D18-W16-L150-Z02-H	18	2	16	150	40			
HM90-LM10-D20-W20-L120-Z03-H	20	3	20	120	30		1070-M3x6.8	
HM90-LM10-D20-W20-L150-Z03-H	20	3	20	150	40			
HM90-LM10-D21-W20-L120-Z03-H	21	3	20	120	30			
HM90-LM10-D22-W20-L120-Z03-H	22	3	20	120	30			
HM90-LM10-D25-W25-L120-Z03-H	25	3	25	120	30			
HM90-LM10-D25-W25-L150-Z03-H	25	3	25	150	40			
HM90-LM10-D32-W32-L150-Z04-H	32	4	32	150	40			

KYCR Compatible With

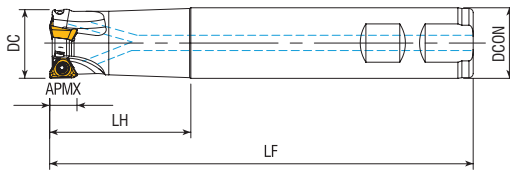

KAPR=90°

 Takım Kodu Ordering Code Bestell-Bezeichnung	Takım Ölçüleri (mm) Dimension (mm) Abmessung (mm)					Kesici Uç Insert Wendeschnei Platte	Sıkma Vidası Screw Schrauble	Anahtar Allen Key Torx Schlüssel
	DC	Z	DCON	LF	LH			
HM90-3P0603-D12-C12-L120-Z01-H	12	1	12	120	25	3PT 0603	1060-M2x4	HTA-T06
HM90-3P0603-D16-W16-L120-Z03-H	16	3	16	120	25			
HM90-3P0603-D20-W20-L150-Z03-H	20	3	20	150	25			
HM90-3P0603-D25-W25-L150-Z05-H	25	5	25	150	25			
HM90-3P1004-D20-W20-L150-Z02-H	20	2	20	150	40	3PT 1004	1060-M3x6	HTA-T08
HM90-3P1004-D21-W20-L150-Z02	21	2	20	150	30			
HM90-3P1004-D22-W20-L150-Z02-H	22	2	20	150	30			
HM90-3P1004-D25-W25-L150-Z03-H	25	3	25	150	40			
HM90-3P1004-D26-W25-L150-Z03	26	3	25	150	40			
HM90-3P1004-D32-W32-L150-Z04-H	26	3	25	150	40			

TGTC Compatible With

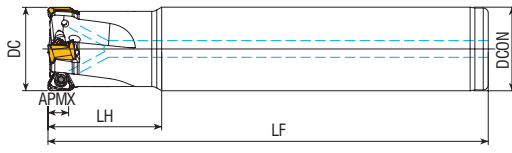

KAPR=90°



 Takım Kodu Ordering Code Bestell-Bezeichnung	Takım Ölçüleri (mm) Dimension (mm) Abmessung (mm)					Kesici Uç Insert Wendeschnei Platte	Sıkma Vidası Screw Schrauble	Anahtar Allen Key Torx Schlüssel
	DC	Z	DCON	LF	LH			
HM90-TN10-D20-W20-L150-Z03-H	20	3	20	150	30			
HM90-TN10-D25-W25-L150-Z04-H	25	4	25	150	30	TNGX 1004.	1060-M2.5x6	HTA-T08
HM90-TN10-D32-W32-L150-Z04-H	32	4	32	150	30			

PMT Compatible With

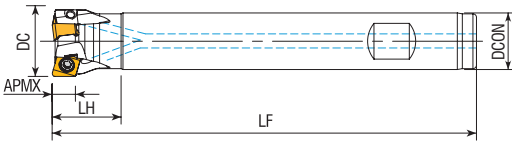

KAPR=90°



 Takım Kodu Ordering Code Bestell-Bezeichnung	Takım Ölçüleri (mm) Dimension (mm) Abmessung (mm)					Kesici Uç Insert Wendeschnei Platte	Sıkma Vidası Screw Schrauble	Anahtar Allen Key Torx Schlüssel
	DC	Z	DCON	LF	LH			
HM90-4N06-D16-W16-L120-Z02-H	16	2	16	120	25			
HM90-4N06-D16-W16-L150-Z02-H	16	2	16	150	25			
HM90-4N06-D17-W16-L150-Z02-H	17	2	16	150	25			
HM90-4N06-D20-W20-L120-Z03-H	20	3	20	120	30			
HM90-4N06-D20-W20-L150-Z03-H	20	3	20	150	30	4NKT 0603.	1070-M3x6.8	HTA-T08
HM90-4N06-D21-W20-L150-Z03-H	21	3	20	150	30			
HM90-4N06-D25-W25-L150-Z03-H	25	3	25	150	40			
HM90-4N06-D26-W25-L150-Z03-H	26	3	25	150	40			
HM90-4N06-D32-W32-L150-Z04-H	32	3	32	150	40			

T07C Compatible With

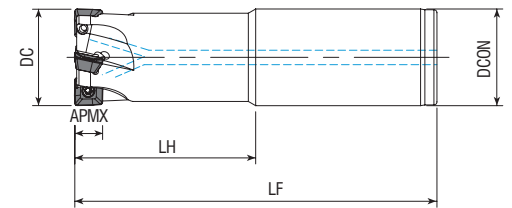

KAPR=90°





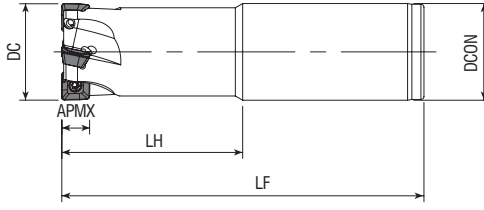

 Takım Kodu Ordering Code Bestell-Bezeichnung	Takım Ölçüleri (mm) Dimension (mm) Abmessung (mm)					Kesici Uç Insert Wendeschnei Platte	Sıkma Vidası Screw Schrauble	Anahtar Allen Key Torx Schlüssel
	DC	Z	DCON	LF	LH			
HM90-SD09T3-D25-W25-L150-Z02-H	25	2	25	150	40			
HM90-SD09T3-D26-W25-L150-Z02-H	26	2	25	150	40	SDMT 09T3.	1070-M3.5x8	HTA-T15
HM90-SD09T3-D32-W32-L150-Z03-H	32	3	32	150	40			

W1TR Compatible With





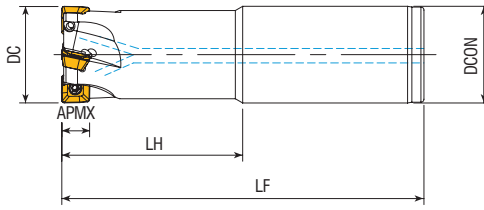

KAPR=90°

 Takım Kodu Ordering Code Bestell-Bezeichnung	Takım Ölçüleri (mm) Dimension (mm) Abmessung (mm)					Kesici Uç Insert Wendeschnei Platte	Sıkma Vidası Screw Schrauble	Anahtar Allen Key Torx Schlüssel
	DC	Z	DCON	LF	LH			
HM90-SPMG0602-D16-W16-L150-Z02	16	2	16	150	50	SPMG 060204	1060-M2.2x5	HTA-T06
HM90-SPMG0602-D17-W16-L150-Z02	17	2	16	150	50			
HM90-SPMG0602-D20-W20-L150-Z03	20	3	20	150	50			
HM90-SPMG07T3-D20-W20-L150-Z03	20	3	20	150	50	SPMG 07T308	1060-M2.5x6	HTA-T08
HM90-SPMG07T3-D22-W20-L150-Z03	22	3	20	150	50			
HM90-SPMG07T3-D25-W25-L150-Z03	25	3	25	150	50			
HM90-SPMG0904-D30-W32-L150-Z03	30	3	32	150	50	SPMG 090408	1060-M3.5x9	HTA-T15
HM90-SPMG0904-D32-W32-L150-Z03	32	3	32	150	50			
HM90-SPMG0904-D33-W32-L150-Z03	33	3	32	150	50			

T07C Compatible With





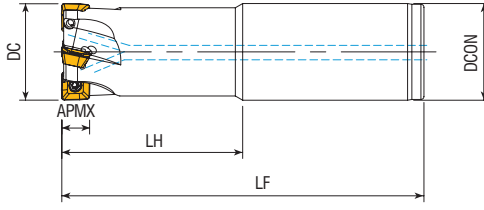

KAPR=90°

 Takım Kodu Ordering Code Bestell-Bezeichnung	Takım Ölçüleri (mm) Dimension (mm) Abmessung (mm)					Kesici Uç Insert Wendeschnei Platte	Sıkma Vidası Screw Schrauble	Anahtar Allen Key Torx Schlüssel
	DC	Z	DCON	LF	LH			
HM90-SD09M4-D25-W25-L150-Z02-H	25	2	25	150	40	SD.09M4..	1060-M3.5x9	HTA-T15
HM90-SD09M4-D32-W32-L150-Z03-H	32	3	32	150	40			
HM90-SD09M4-D35-W32-L150-Z03-H	35	3	32	15	40			

K07V Compatible With





KAPR=90°

 Takım Kodu Ordering Code Bestell-Bezeichnung	Takım Ölçüleri (mm) Dimension (mm) Abmessung (mm)					Kesici Uç Insert Wendeschnelplatte	Sıkma Vidası Screw Schraube	Anahtar Allen Key Torx Schlüssel
	DC	Z	DCON	LF	LH			
HM90-490R08-D20-W20-L150-Z02-H	20	2	20	150	40			
HM90-490R08-D25-W25-L150-Z03-H	25	3	25	150	40			
HM90-490R08-D26-W25-L150-Z03-H	26	3	25	150	40	490R-08T3.	1060-M2.5x7	HTA-T08
HM90-490R08-D32-W32-L150-Z04-H	32	4	32	150	40			
HM90-490R08-D33-W32-L150-Z04-H	33	4	32	15	40			

SMDYK Compatible With

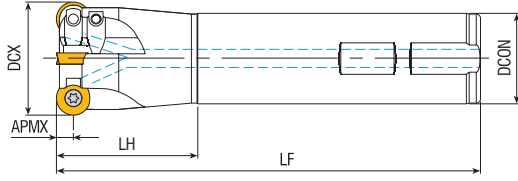



 Takım Kodu Ordering Code Bestell-Bezeichnung	Takım Ölçüleri (mm) Dimension (mm) Abmessung (mm)					Kesici Uç Insert Wendschnei Platte	Sıkma Vidası Screw Schrauble	Anahtar Allen Key Torx Schlüssel
	DC	Z	DCON	LF	LH			
HM-RD0501-D08-W10-L100-Z01-H	8	1	10	100	20	RD. 0501	1060-M2x4	HTA-T06
HM-RD0501-D10-W12-L100-Z02-H	10	2	12	100	20			
HM-RD0501-D12-W12-L120-Z02-H	12	2	12	120	20			
HM-RD0803-D16-W16-L150-Z02	16	2	16	150	60	RD. 0803	1060-M3x6	HTA-T08
HM-RD0803-D16-C20-L200-Z02	16	2	20	200	60			
HM-RD0803-D20-W20-L150-Z03	20	3	20	150	60			
HM-RD0803-D25-W25-L150-Z02	25	2	25	150	60			
HM-RD1003-D20-W20-L150-Z02	20	2	20	150	60	RD. 1003	1060-M3.5x9	HTA-T15
HM-RD1003-D20-C20-L250-Z02	20	2	20	250	150			
HM-RD1003-D21-C20-L150-Z02	21	2	20	150	70			
HM-RD1003-D25-W25-L150-Z02	25	2	25	150	60			
HM-RD1003-D25-C25-L150-Z02	25	2	25	150	70			
HM-RD1003-D25-W25-L200-Z02	25	2	25	200	100			
HM-RD1003-D25-C25-L200-Z02	25	2	25	200	100			
HM-RD1003-D25-C25-L250-Z02	25	2	25	250	150			
HM-RD1003-D26-C25-L150-Z02	26	2	25	150	70			
HM-RD1003-D32-W32-L150-Z03	32	3	32	150	60			
HM-RD1003-D32-C32-L250-Z02	32	2	32	250	150			
HM-RD1003-D33-C32-L150-Z03	33	3	32	150	70			
HM-RD1003-D40-W32-L150-Z04	40	4	32	150	35			
HM-RD1003-D40-C32-L250-Z02	40	2	32	250	50			
HM-RD10T3-D20-C20-L150-Z02	20	2	20	150	60	RD. 10T3	1060-M3.5x9	HTA-T15
HM-RD10T3-D20-W20-L150-Z02	20	2	20	150	60			
HM-RD10T3-D25-C25-L150-Z02	25	2	25	150	60			
HM-RD10T3-D25-C25-L200-Z02-H	25	2	25	200	100			
HM-RD10T3-D25-W25-L150-Z02	25	2	25	150	60			
HM-RD10T3-D32-C25-L250-Z03-H	32	3	25	250	35			
HM-RD10T3-D32-W32-L150-Z03	32	3	32	150	60			
HM-RD12T3-D25-W25-L150-Z02	25	2	25	150	60	RD. 12T3	1060-M3.5x9	HTA-T15
HM-RD12T3-D25-W25-L200-Z02	25	2	25	200	100			
HM-RD12T3-D25-C25-L250-Z02	25	2	25	250	150			
HM-RD12T3-D25-C25-L300-Z02	25	2	25	300	200			
HM-RD12T3-D32-W32-L150-Z03	32	3	32	150	60			
HM-RD12T3-D32-C32-L250-Z02	32	2	32	250	150			
HM-RD12T3-D40-W32-L150-Z04	40	4	32	150	50			
HM-RD12T3-D40-C32-L250-Z02	40	2	32	250	50			
HM-RD1204-D32-C32-L150-Z03	32	3	32	150	70	RD. 1204	1060-M3.5x9	HTA-T15
HM-RD1204-D32-W32-L150-Z03	32	3	32	150	70			
HM-RD1204-D33-C32-L150-Z03	33	3	32	150	70			

ISO Compatible With



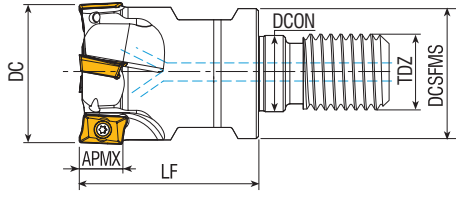

Perfect
Cut





KAPR=90°





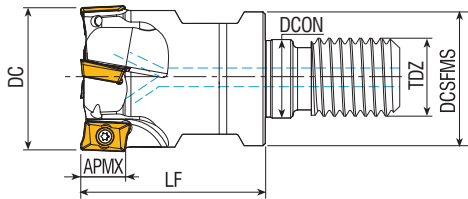

 Takım Kodu Ordering Code Bestell-Bezeichnung	Takım Ölçüleri (mm) Dimension (mm) Abmessung (mm)						Kesici Uç Insert Wendschnei-Platte	Sıkma Vidası Screw Schraube	Anahtar Allen Key Torx Schlüssel
	DC	Z	DCSFMS	TDZ	LF	DCON			
HM90-AP10-D16-M08-L25-Z02-H	16	2	14.75	M08	25	8.5	AP. 1003.	1060-M2.5x6	HTA-T08
HM90-AP10-D20-M10-L30-Z03-H	20	3	18	M10	30	10.5			
HM90-AP10-D25-M12-L35-Z03-H	25	3	21	M12	35	12.5			
HM90-AP10-D32-M16-L43-Z04-H	32	4	29	M16	43	17			
HM90-AP10-D40-M16-L43-Z05-H	40	5	29	M16	43	17			
HM90-AP16-D25-M12-L35-Z02-H	25	2	21	M12	35	12.5	AP. 1604.	1060-M4x9	HTA-T15
HM90-AP16-D32-M16-L43-Z03-H	32	3	29	M16	43	17			
HM90-AP16-D40-M16-L43-Z04-H	40	4	29	M16	43	17			
HM90-AP16-D42-M16-L43-Z04-H	42	4	29	M16	43	17			

ISO Compatible With



KAPR=90°





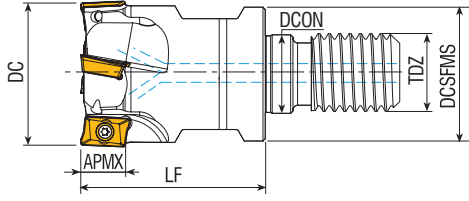

 Takım Kodu Ordering Code Bestell-Bezeichnung	Takım Ölçüleri (mm) Dimension (mm) Abmessung (mm)						Kesici Uç Insert Wendschnei-Platte	Sıkma Vidası Screw Schraube	Anahtar Allen Key Torx Schlüssel
	DC	Z	DCSFMS	TDZ	LF	DCON			
HM90-AP09-D16-M08-L25-Z02-H	16	2	14.75	M08	25	8.5	AP. 09T3.	1060-M2.5x6	HTA-T08
HM90-AP09-D20-M10-L30-Z03-H	20	3	18	M10	30	10.5			
HM90-AP09-D25-M12-L35-Z03-H	25	3	21	M12	35	12.5			
HM90-AP12-D20-M10-L30-Z02-H	20	2	18	M10	30	10.5	AP. 1204.	1070-M3.5x8	HTA-T15
HM90-AP12-D25-M12-L35-Z03-H	25	3	21	M12	35	12.5			
HM90-AP12-D32-M16-L43-Z04-H	32	4	29	M16	43	17	AP. 1705.	1060-M4x9	HTA-T15
HM90-AP17-D25-M12-L35-Z02-H	25	2	21	M12	35	12.5			
HM90-AP17-D32-M16-L43-Z03-H	32	3	29	M16	43	17			
HM90-AP17-D40-M16-L43-Z04-H	40	4	29	M16	43	17			
HM90-AP17-D42-M16-L43-Z04-H	42	4	29	M16	43	17			

T0TC Compatible With



KAPR=90°





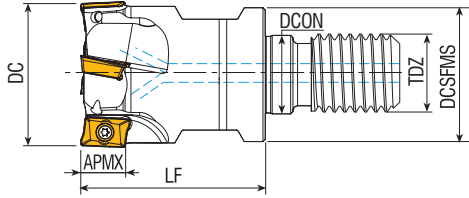

 Takım Kodu Ordering Code Bestell-Bezeichnung	Takım Ölçüleri (mm) Dimension (mm) Abmessung (mm)						Kesici Uç Insert Wendeschnei Platte	Sıkma Vidası Screw Schrauble	Anahtar Allen Key Torx Schlüssel
	DC	Z	DCSFMS	TDZ	LF	DCON			
HM90-AP11T3-D16-M08-L25-Z02-H	16	2	14.75	M08	25	8.5			
HM90-AP11T3-D20-M10-L30-Z03-H	20	3	18	M10	30	10.5	APMT 11T3..	1060-M2.5x6	HTA-T08
HM90-AP11T3-D25-M12-L35-Z03-H	25	3	21	M12	35	12.5			

KRV Compatible With



KAPR=90°





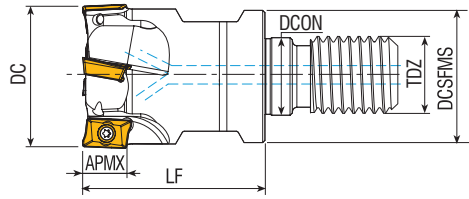

 Takım Kodu Ordering Code Bestell-Bezeichnung	Takım Ölçüleri (mm) Dimension (mm) Abmessung (mm)						Kesici Uç Insert Wendeschnei Platte	Sıkma Vidası Screw Schrauble	Anahtar Allen Key Torx Schlüssel
	DC	Z	DCSFMS	TDZ	LF	DCON			
HM90-AP1135-D16-M08-L25-Z02-H	16	2	14.75	M08	25	8.5			
HM90-AP1135-D20-M10-L30-Z03-H	20	3	18	M10	30	10.5	APMT 1135..	1060-M2.5x6	HTA-T08
HM90-AP1135-D25-M12-L35-Z03-H	25	3	21	M12	35	12.5			
HM90-AP1135-D32-M16-L43-Z04-H	32	4	29	M16	43	17			

YG Compatible With



KAPR=90°





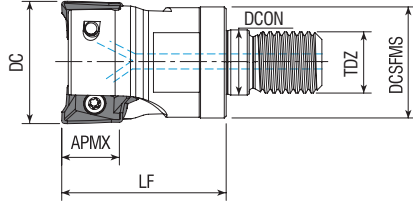

 Takım Kodu Ordering Code Bestell-Bezeichnung	Takım Ölçüleri (mm) Dimension (mm) Abmessung (mm)						Kesici Uç Insert Wendeschnei Platte	Sıkma Vidası Screw Schrauble	Anahtar Allen Key Torx Schlüssel
	DC	Z	DCSFMS	TDZ	LF	DCON			
HM90-AP11-D16-M08-L25-Z02-H	16	2	14.75	M08	25	8.5			
HM90-AP11-D20-M10-L30-Z03-H	20	3	18	M10	30	10.5	AP. 11T3..	1060-M2.5x6	HTA-T08
HM90-AP11-D25-M12-L35-Z03-H	25	3	21	M12	35	12.5			
HM90-AP11-D32-M16-L43-Z04-H	32	4	29	M16	43	17			

ZCC Compatible With



KAPR=90°





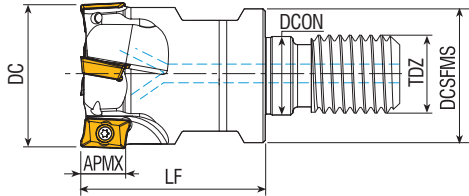

 Takım Kodu Ordering Code Bestell-Bezeichnung	Takım Ölçüleri (mm) Dimension (mm) Abmessung (mm)						Kesici Uç Insert Wendschnei-Platte	Sıkma Vidası Screw Schrauble	Anahtar Allen Key Torx Schlüssel
	DC	Z	DCSFMS	TDZ	LF	DCON			
HM90-AX1235-D16-M08-L25-Z02-H	16	2	14.75	M08	25	8.5			
HM90-AX1235-D20-M10-L30-Z03-H	20	3	18	M10	30	10.5	AX.T 1235..	1070-M3x6.8	HTA-T08
HM90-AX1235-D25-M12-L35-Z04-H	25	4	21	M12	35	12.5			
HM90-AX1705-D25-M12-L35-Z02-H	25	2	21	M12	35	12.5			
HM90-AX1705-D32-M16-L43-Z03-H	32	3	29	M16	43	17	AX.T 1705..	1060-M4x9	HTA-T15
HM90-AX1705-D40-M16-L43-Z04-H	40	4	29	M16	43	17			

SNM Compatible With



KAPR=90°





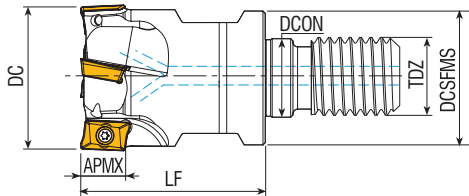

 Takım Kodu Ordering Code Bestell-Bezeichnung	Takım Ölçüleri (mm) Dimension (mm) Abmessung (mm)						Kesici Uç Insert Wendschnei-Platte	Sıkma Vidası Screw Schrauble	Anahtar Allen Key Torx Schlüssel
	DC	Z	DCSFMS	TDZ	LF	DCON			
HM90-XO10-D16-M08-L25-Z02-H	16	2	14.75	M08	25	8.5			
HM90-XO10-D20-M10-L30-Z03-H	20	3	18	M10	30	10.5	XO.10T3..	1060-M2.5x5	HTA-T08
HM90-XO10-D25-M12-L35-Z04-H	25	4	21	M12	35	12.5			
HM90-XO12-D20-M10-L30-Z02-H	20	2	18	M10	30	10.5			
HM90-XO12-D25-M12-L35-Z03-H	25	3	21	M12	35	12.5	XO. 1204..	1070-M3.5x8	HTA-T15
HM90-XO12-D32-M16-L43-Z04-H	32	4	29	M16	43	17			

SCO Compatible With



KAPR=90°



 Takım Kodu Ordering Code Bestell-Bezeichnung	Takım Ölçüleri (mm) Dimension (mm) Abmessung (mm)						Kesici Uç Insert Wendschnei-Platte	Sıkma Vidası Screw Schrauble	Anahtar Allen Key Torx Schlüssel
	DC	Z	DCSFMS	TDZ	LF	DCON			
HM90-XD11T3-D16-M08-L25-Z02-H	16	2	14.75	M08	25	8.5			
HM90-XD11T3-D20-M10-L30-Z03-H	20	3	18	M10	30	10.5	XD.T 11T3..	1060-M2.5x6	HTA-T08
HM90-XD11T3-D25-M12-L35-Z03-H	25	3	21	M12	35	12.5			

CRZ Compatible With

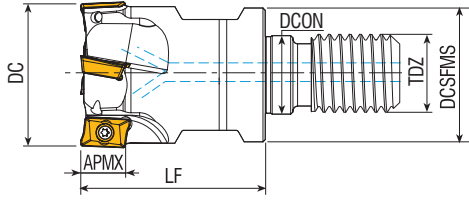

KAPR=90°



 Takım Kodu Ordering Code Bestell-Bezeichnung	Takım Ölçüleri (mm) Dimension (mm) Abmessung (mm)						Kesici Uç Insert Wendeschnei Platte	Sıkma Vidası Screw Schraube	Anahtar Allen Key Torx Schlüssel
	DC	Z	DCSFMS	TDZ	LF	DCON			
HM90-AD0803-D16-M08-L25-Z02-H	16	2	14.75	M08	25	8.5			
HM90-AD0803-D20-M10-L30-Z03-H	20	3	18	M10	30	10.5	ADMT 0803.	1060-M2.5x6	HTA-T08
HM90-AD0803-D25-M12-L35-Z04-H	25	4	21	M12	35	12.5			
HM90-AD10T3-D16-M08-L25-Z02-H	16	2	14.75	M08	25	8.5			
HM90-AD10T3-D20-M10-L30-Z03-H	20	3	18	M10	30	10.5	ADMT 10T3.	1060-M2.5x6	HTA-T08
HM90-AD10T3-D25-M12-L35-Z04-H	25	4	21	M12	35	12.5			
HM90-AD1204-D20-M10-L30-Z02-H	20	2	18	M10	30	10.5			
HM90-AD1204-D25-M12-L35-Z03-H	25	3	21	M12	35	12.5	ADMT 1204.	1060-M3x8	HTA-T08
HM90-AD1204-D32-M16-L43-Z04-H	32	4	29	M16	43	17			

WTR Compatible With

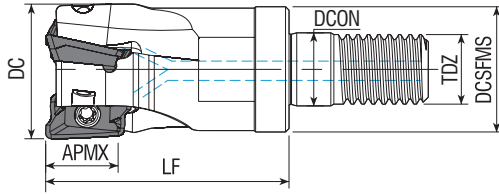

KAPR=90°



 Takım Kodu Ordering Code Bestell-Bezeichnung	Takım Ölçüleri (mm) Dimension (mm) Abmessung (mm)						Kesici Uç Insert Wendeschnei Platte	Sıkma Vidası Screw Schraube	Anahtar Allen Key Torx Schlüssel
	DC	Z	DCSFMS	TDZ	LF	DCON			
HM90-AO12-D16-M08-L25-Z02-H	16	2	14.75	M08	25	8.5			
HM90-AO12-D20-M10-L30-Z03-H	20	3	18	M10	30	10.5	AO.1236	1060-M2.5x6	HTA-T08
HM90-AO12-D25-M12-L35-Z04-H	25	4	21	M12	35	12.5			
HM90-AO12-D32-M16-L43-Z05-H	32	5	29	M16	43	17			

MTSBH Compatible With

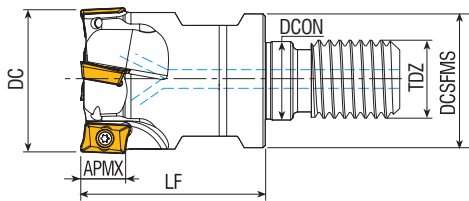

KAPR=90°



 Takım Kodu Ordering Code Bestell-Bezeichnung	Takım Ölçüleri (mm) Dimension (mm) Abmessung (mm)						Kesici Uç Insert Wendeschnei Platte	Sıkma Vidası Screw Schraube	Anahtar Allen Key Torx Schlüssel
	DC	Z	DCSFMS	TDZ	LF	DCON			
HM90-AD1505-D25-M12-L35-Z02-H	25	2	21	M12	35	12.5	AD.1505.	1060-M4x9	HTA-T15
HM90-AD1505-D32-M16-L43-Z03-H	32	3	29	M16	43	17			

ISCR Compatible With

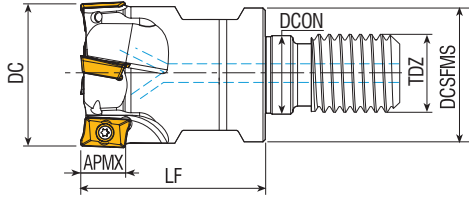

KAPR=90°



 Takım Kodu Ordering Code Bestell-Bezeichnung	Takım Ölçüleri (mm) Dimension (mm) Abmessung (mm)						Kesici Uç Insert Wendschnei Platte	Sıkma Vidası Screw Schrauble	Anahtar Allen Key Torx Schlüssel
	DC	Z	DCSFMS	TDZ	LF	DCON			
HM90-ED10-D16-M08-L25-Z02-H	16	2	14.75	M08	25	8.5	EDPT10T3.	1060-M2.5x6	HTA-T08
HM90-ED10-D20-M10-L30-Z02-H	20	2	18	M10	30	10.5			
HM90-ED10-D25-M12-L35-Z03-H	25	3	21	M12	35	12.5			
HM90-ED10-D32-M16-L43-Z04-H	32	4	29	M16	43	17			
HM90-ED14-D20-M10-L30-Z02-H	20	2	18	M10	30	10.5	EDPT1404.	1060-M3x6	HTA-T08
HM90-ED14-D25-M12-L35-Z02-H	25	2	21	M12	35	12.5			
HM90-ED14-D32-M16-L43-Z03-H	32	3	29	M16	43	17			

KMWT Compatible With

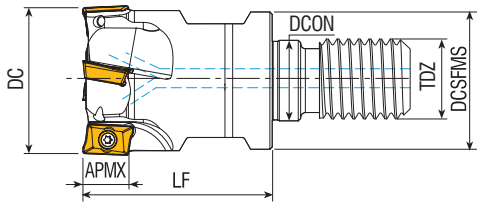

KAPR=90°



 Takım Kodu Ordering Code Bestell-Bezeichnung	Takım Ölçüleri (mm) Dimension (mm) Abmessung (mm)						Kesici Uç Insert Wendschnei Platte	Sıkma Vidası Screw Schrauble	Anahtar Allen Key Torx Schlüssel
	DC	Z	DCSFMS	TDZ	LF	DCON			
HM90-R390.11-D16-M08-L25-Z02-H	16	2	14.75	M08	25	8.5	R390-11T3.	1060-M2.5x6	HTA-T08
HM90-R390.11-D20-M10-L30-Z03-H	20	3	18	M10	30	10.5			
HM90-R390.11-D25-M12-L35-Z03-H	25	3	21	M12	35	12.5			
HM90-R390.11-D32-M16-L43-Z04-H	32	4	29	M16	43	17			

SNDK Compatible With

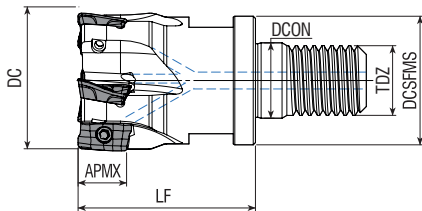

KAPR=90°







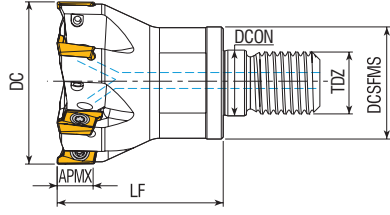

 Takım Kodu Ordering Code Bestell-Bezeichnung	Takım Ölçüleri (mm) Dimension (mm) Abmessung (mm)						Kesici Uç Insert Wendschnei Platte	Sıkma Vidası Screw Schrauble	Anahtar Allen Key Torx Schlüssel
	DC	Z	DCSFMS	TDZ	LF	DCON			
HM90-BD11T3-D16-M08-L25-Z02-H	16	2	14.75	M08	25	8.5	BDMT 11T3.	1060-M2.5x6	HTA-T08
HM90-BD11T3-D20-M10-L30-Z03-H	20	3	18	M10	30	10.5			
HM90-BD11T3-D25-M12-L35-Z04-H	25	4	21	M12	35	12.5			
HM90-BD11T3-D32-M16-L43-Z05-H	32	5	29	M16	43	17			

KVCR Compatible With







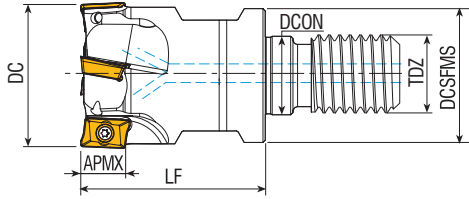

KAPR=90°

 Takım Kodu Ordering Code Bestell-Bezeichnung	Takım Ölçüleri (mm) Dimension (mm) Abmessung (mm)						Kesici Uç Insert Wendeschnelplatte	Sıkma Vidası Screw Schraube	Anahtar Allen Key Torx Schlüssel
	DC	Z	DCSFMS	TDZ	LF	DCON			
HM90-RT10-D16-M08-L25-Z02-H	16	2	14.75	M08	25	8.5			
HM90-RT10-D20-M10-L30-Z03-H	20	3	18	M10	30	10.5			
HM90-RT10-D25-M12-L35-Z04-H	25	4	21	M12	35	12.5			
HM90-RT10-D32-M16-L43-Z05-H	32	5	29	M16	43	17			
HM90-RT10-D42-M16-L43-Z06-H	42	6	29	M16	43	17			

SFTY Compatible With







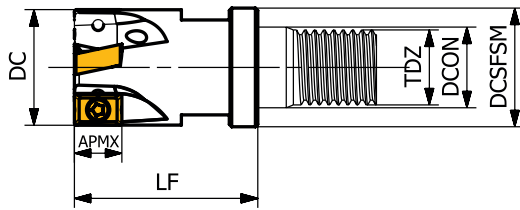

KAPR=90°

 Takım Kodu Ordering Code Bestell-Bezeichnung	Takım Ölçüleri (mm) Dimension (mm) Abmessung (mm)						Kesici Uç Insert Wendeschnelplatte	Sıkma Vidası Screw Schraube	Anahtar Allen Key Torx Schlüssel
	DC	Z	DCSFMS	TDZ	LF	DCON			
HM90-AS11-D20-M10-L30-Z03-H	20	3	18	M10	30	10.5			
HM90-AS11-D25-M12-L35-Z04-H	25	4	21	M12	35	12.5			
HM90-AS11-D32-M16-L43-Z05-H	32	5	29	M16	43	17			

TNGLY Compatible With









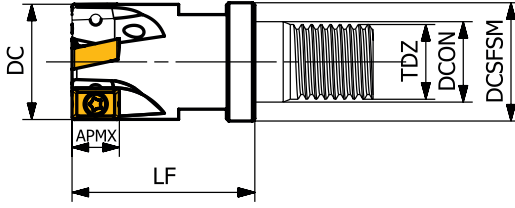



KAPR=90°

 Takım Kodu Ordering Code Bestell-Bezeichnung	Takım Ölçüleri (mm) Dimension (mm) Abmessung (mm)						Kesici Uç Insert Wendeschnelplatte	Sıkma Vidası Screw Schraube	Anahtar Allen Key Torx Schlüssel
	DC	Z	DCSFMS	TDZ	LF	DCON			
HM90-AN09-D20-M10-L30-Z03-H	20	3	18	M10	30	10.5			
HM90-AN09-D25-M12-L35-Z04-H	25	4	21	M12	35	12.5			
HM90-AN09-D32-M16-L43-Z05-H	32	5	29	M16	43	17			

ISCR Compatible With







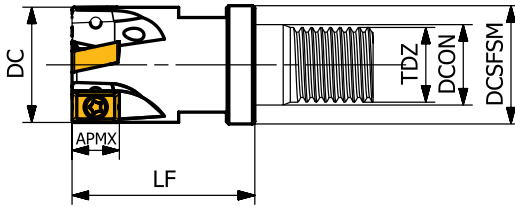

KAPR=90°

 Takım Kodu Ordering Code Bestell-Bezeichnung	Takım Ölçüleri (mm) Dimension (mm) Abmessung (mm)						Kesici Uç Insert Wendschnei Platte	Sıkma Vidası Screw Schrauble	Anahtar Allen Key Torx Schlüssel
	DC	Z	DCSFMS	TDZ	LF	DCON			
HM90-LN1006-D20-M10-L30-Z02-H	20	2	18	M10	30	10.5			
HM90-LN1006-D25-M12-L35-Z03-H	25	3	21	M12	35	12.5	LN.X 1006..	1060-M3x8	HTA-T08
HM90-LN1006-D32-M16-L43-Z04-H	32	4	29	M16	43	17			

KRV Compatible With









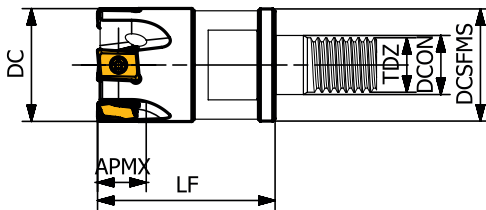



KAPR=90°

 Takım Kodu Ordering Code Bestell-Bezeichnung	Takım Ölçüleri (mm) Dimension (mm) Abmessung (mm)						Kesici Uç Insert Wendschnei Platte	Sıkma Vidası Screw Schrauble	Anahtar Allen Key Torx Schlüssel
	DC	Z	DCSFMS	TDZ	LF	DCON			
HM90-AN11-D25-M12-L35-Z02-H	25	2	21	M12	35	12.5	ANGX 1105..	1060-M3x8	HTA-T08
HM90-AN11-D32-M16-L43-Z03-H	32	3	29	M16	43	17			

ZCC Compatible With



KAPR=90°





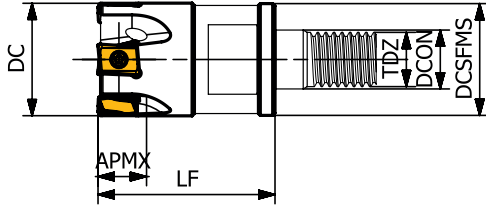

 Takım Kodu Ordering Code Bestell-Bezeichnung	Takım Ölçüleri (mm) Dimension (mm) Abmessung (mm)						Kesici Uç Insert Wendschnei Platte	Sıkma Vidası Screw Schrauble	Anahtar Allen Key Torx Schlüssel
	DC	Z	DCSFMS	TDZ	LF	DCON			
HM90-LN08-D20-M10-L30-Z03-H	20	3	18	M10	30	10.5			
HM90-LN08-D25-M12-L35-Z04-H	25	4	21	M12	35	12.5	LNMT 0804..	1060-M2.5x6	HTA-T08
HM90-LN08-D32-M16-L43-Z05-H	32	5	29	M16	43	17			

ISC8 Compatible With



KAPR=90°







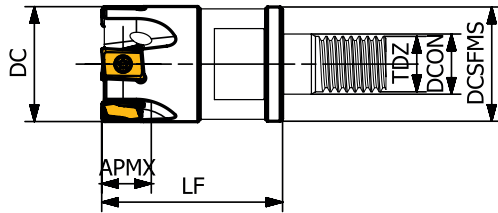

 Takım Kodu Ordering Code Bestell-Bezeichnung	Takım Ölçüleri (mm) Dimension (mm) Abmessung (mm)						Kesici Uç Insert Wendeschnei Platte	Sıkma Vidası Screw Schrauble	Anahtar Allen Key Torx Schlüssel
	DC	Z	DCSFMS	TDZ	LF	DCON			
HM90-LX08-D20-M10-L30-Z03-H	20	3	18	M10	30	10.5			
HM90-LX08-D25-M12-L35-Z04-H	25	4	21	M12	35	12.5	LOEX 0804..	1060-M2.5x6	HTA-T08
HM90-LX08-D32-M16-L43-Z05-H	32	5	29	M16	43	17			

SCD Compatible With



KAPR=90°







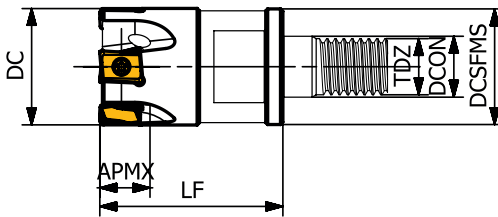

 Takım Kodu Ordering Code Bestell-Bezeichnung	Takım Ölçüleri (mm) Dimension (mm) Abmessung (mm)						Kesici Uç Insert Wendeschnei Platte	Sıkma Vidası Screw Schrauble	Anahtar Allen Key Torx Schlüssel
	DC	Z	DCSFMS	TDZ	LF	DCON			
HM90-LO09-D20-M10-L30-Z03-H	20	3	18	M10	30	10.5			
HM90-LO09-D25-M12-L35-Z04-H	25	4	21	M12	35	12.5	LOGU 0904..	1060-M2.5x6	HTA-T08
HM90-LO09-D32-M16-L43-Z05-H	32	5	29	M16	43	17			

MTSBH Compatible With



KAPR=90°





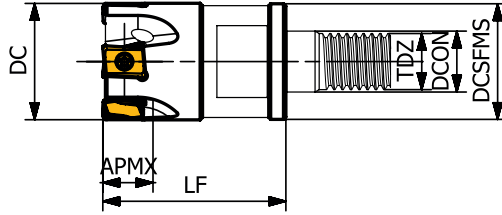

 Takım Kodu Ordering Code Bestell-Bezeichnung	Takım Ölçüleri (mm) Dimension (mm) Abmessung (mm)						Kesici Uç Insert Wendeschnei Platte	Sıkma Vidası Screw Schrauble	Anahtar Allen Key Torx Schlüssel
	DC	Z	DCSFMS	TDZ	LF	DCON			
HM90-LP09-D20-M10-L30-Z03-H	20	3	18	M10	30	10.5			
HM90-LP09-D25-M12-L35-Z04-H	25	4	21	M12	35	12.5	LPU 0904..	1060-M3x8	HTA-T08
HM90-LP09-D32-M16-L43-Z05-H	32	5	29	M16	43	17			

TGTC Compatible With



KAPR=90°





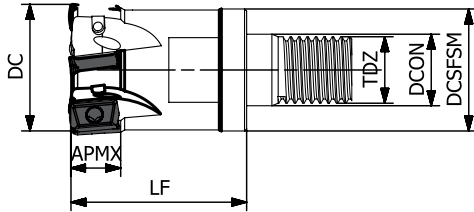

 Takım Kodu Ordering Code Bestell-Bezeichnung	Takım Ölçüleri (mm) Dimension (mm) Abmessung (mm)						Kesici Uç Insert Wändeschneideplatte	Sıkma Vidası Screw Schraube	Anahtar Allen Key Torx Schlüssel
	DC	Z	DCSFMS	TDZ	LF	DCON			
HM90-LH09-D20-M10-L30-Z03-H	20	3	18	M10	30	10.5			
HM90-LH09-D25-M12-L35-Z04-H	25	4	21	M12	35	12.5	LNHU 0904.	1060-M3x8	HTA-T08
HM90-LH09-D32-M16-L43-Z05-H	32	5	29	M16	43	17			

WTR cana uygundur



KAPR=90°





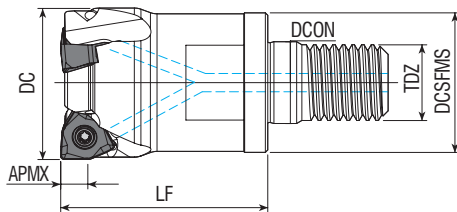

 Takım Kodu Ordering Code Bestell-Bezeichnung	Takım Ölçüleri (mm) Dimension (mm) Abmessung (mm)						Kesici Uç Insert Wändeschneideplatte	Sıkma Vidası Screw Schraube	Anahtar Allen Key Torx Schlüssel
	DC	Z	DCSFMS	TDZ	LF	DCON			
HM90-LM10-D20-M10-L30-Z03-H	20	3	18	M10	30	10.5			
HM90-LM10-D25-M12-L35-Z03-H	25	3	21	M12	35	12.5	LOMU 1004.	1070-M3x6.8	HTA-T08
HM90-LM10-D32-M16-L43-Z04-H	32	4	29	M16	43	17			

KTR cana uygundur



KAPR=90°



 Takım Kodu Ordering Code Bestell-Bezeichnung	Takım Ölçüleri (mm) Dimension (mm) Abmessung (mm)						Kesici Uç Insert Wändeschneideplatte	Sıkma Vidası Screw Schraube	Anahtar Allen Key Torx Schlüssel
	DC	Z	DCSFMS	TDZ	LF	DCON			
HM90-XN0403-D20-M10-L30-Z03-H	20	3	18	M10	30	10.5			
HM90-XN0403-D25-M12-L35-Z04-H	25	4	21	M12	35	12.5	XNEX 0403.	1060-M2.5x6	HTA-T08
HM90-XN0403-D32-M16-L43-Z05-H	32	5	29	M16	43	17			
HM90-XN0403-D42-M16-L43-Z06-H	42	6	29	M16	43	17			

SCO cana uygundur

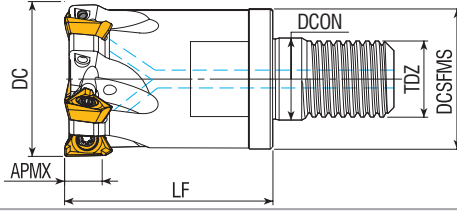

KAPR=90°



 Takım Kodu Ordering Code Bestell-Bezeichnung	Takım Ölçüleri (mm) Dimension (mm) Abmessung (mm)						Kesici Uç Insert Wendschnei Platte	Sıkma Vidası Screw Schrauble	Anahtar Allen Key Torx Schlüssel
	DC	Z	DCSFMS	TDZ	LF	DCON			
HM90-3P1004-D20-M10-L30-Z02-H	20	2	18	M10	30	10.5			
HM90-3P1004-D25-M12-L35-Z03-H	25	3	21	M12	35	12.5	3PT1004	1060-M3x6	HTA-T08
HM90-3P1004-D32-M16-L43-Z04-H	32	4	29	M16	43	17			
HM90-3P1004-D40-M16-L43-Z05-H	40	5	29	M16	43	17			

TCTC Compatible With

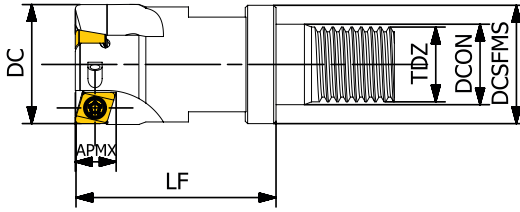

KAPR=90°



 Takım Kodu Ordering Code Bestell-Bezeichnung	Takım Ölçüleri (mm) Dimension (mm) Abmessung (mm)						Kesici Uç Insert Wendschnei Platte	Sıkma Vidası Screw Schrauble	Anahtar Allen Key Torx Schlüssel
	DC	Z	DCSFMS	TDZ	LF	DCON			
HM90-4N06-D16-M08-L25-Z02-H	16	2	14.75	M08	25	8.5			
HM90-4N06-D20-M10-L30-Z03-H	20	3	18	M10	30	10.5	4NKT 0603.	1070-M3x6.8	HTA-T08
HM90-4N06-D25-M12-L35-Z03-H	25	3	21	M12	35	12.5			
HM90-4N06-D32-M16-L43-Z04-H	32	4	29	M16	43	17			
HM90-4N06-D40-M16-L43-Z05-H	40	5	29	M16	43	17			

TCTC Compatible With

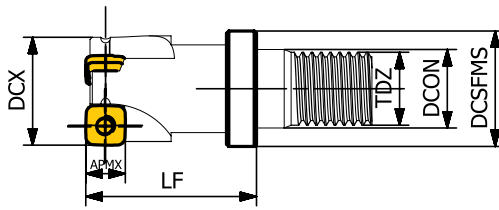





KAPR=90°

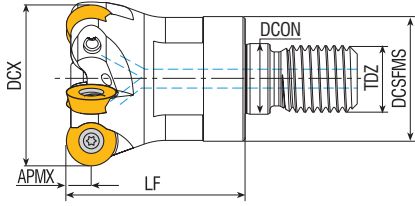

 Takım Kodu Ordering Code Bestell-Bezeichnung	Takım Ölçüleri (mm) Dimension (mm) Abmessung (mm)						Kesici Uç Insert Wendschnei Platte	Sıkma Vidası Screw Schrauble	Anahtar Allen Key Torx Schlüssel
	DC	Z	DCSFMS	TDZ	LF	DCON			
HM90-490R08-D20-M10-L30-Z02-H	20	2	18	M10	30	10.5			
HM90-490R08-D25-M12-L35-Z03-H	25	3	21	M12	35	12.5	490R-08T3.	1060-M2.5x7	HTA-T08
HM90-490R08-D32-M16-L43-Z04-H	32	4	29	M16	43	17			

SMDVC Compatible With



 Takım Kodu Ordering Code Bestell-Bezeichnung	Takım Ölçüleri (mm) Dimension (mm) Abmessung (mm)						Kesici Uç Insert Wändeschneideplatte	Sıkma Vidası Screw Schraube	Anahtar Allen Key Torx Schlüssel
	DC	Z	DCON	LF	LF	DCON			
HM-RD07-D16-M08-L25-Z02-H	16	2	14.75	M08	25	8.5	RD. 0702	1060-M2.5x6	HTA-T08
HM-RD07-D20-M10-L30-Z04-H	20	4	18	M10	30	10.5			
HM-RD07-D25-M12-L35-Z04-H	25	4	21	M12	35	12.5			
HM-RD07-D30-M16-L43-Z05-H	30	5	29	M16	43	17			
HM-RD07-D32-M16-L43-Z05-H	32	5	29	M16	43	17			
HM-RD0803-D16-M08-L25-Z02-H	16	2	14.75	M08	25	8.5	RD. 0803	1060-M3x6	HTA-T08
HM-RD0803-D20-M10-L30-Z03-H	20	3	18	M10	30	10.5			
HM-RD0803-D25-M12-L35-Z03-H	25	3	21	M12	35	12.5			
HM-RD0803-D32-M16-L43-Z04-H	32	4	29	M16	43	17			
HM-RD0803-D35-M16-L43-Z05-H	35	5	29	M16	43	17			
HM-RD1003-D20-M10-L30-Z02-H	20	2	18	M10	30	10.5	RD. 1003	1060-M3.5x9	HTA-T15
HM-RD1003-D25-M12-L35-Z03-H	25	3	21	M12	35	12.5			
HM-RD1003-D32-M16-L43-Z04-H	32	4	29	M16	43	17			
HM-RD1003-D35-M16-L43-Z05-H	35	5	29	M16	43	17			
HM-RD1003-D40-M16-L43-Z05-H	40	5	29	M16	43	17			
HM-RD1003-D42-M16-L43-Z05-H	42	5	29	M16	43	17			
HM-RD10T3-D20-M10-L30-Z02-H	20	2	18	M10	30	10.5	RD. 10T3	1060-M3.5x9	HTA-T15
HM-RD10T3-D25-M12-L35-Z03-H	25	3	21	M12	35	12.5			
HM-RD10T3-D32-M16-L43-Z03-H	32	3	29	M16	43	17			
HM-RD10T3-D35-M16-L43-Z04-H	35	4	29	M16	43	17			
HM-RD10T3-D42-M16-L43-Z05-H	42	5	29	M16	43	17			
HM-RD12T3-D24-M12-L35-Z02-H	24	2	21	M12	35	12.5	RD. 12T3	1060-M3.5x9	HTA-T15
HM-RD12T3-D25-M12-L35-Z02-H	25	2	21	M12	35	12.5			
HM-RD12T3-D32-M16-L43-Z03-H	32	3	29	M16	43	17			
HM-RD12T3-D35-M16-L43-Z03-H	35	3	29	M16	43	17			
HM-RD12T3-D40-M16-L43-Z04-H	40	4	29	M16	43	17			
HM-RD12T3-D42-M16-L43-Z04-H	42	4	29	M16	43	17			
HM-RD1204-D25-M12-L35-Z02-H	25	2	21	M12	35	12.5	RD. 1204	1060-M3.5x9	HTA-T15
HM-RD1204-D32-M16-L43-Z03-H	32	3	29	M16	43	17			
HM-RD1204-D35-M16-L43-Z03-H	35	3	29	M16	43	17			
HM-RD1204-D40-M16-L43-Z04-H	40	4	29	M16	43	17			
HM-RD1204-D42-M16-L43-Z04-H	42	4	29	M16	43	17			
HM-RD1604-D32-M16-L43-Z03-H	32	3	29	M16	43	17	RD. 1604	1060-M4.5x12	HTA-T20
HM-RD1604-D40-M16-L43-Z04-H	40	4	29	M16	43	17			
HM-RD1604-D42-M16-L43-Z04-H	42	4	29	M16	43	17			

ISO Compatible With



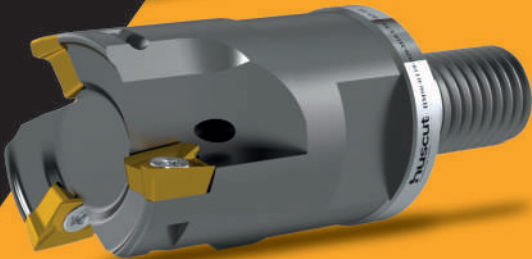
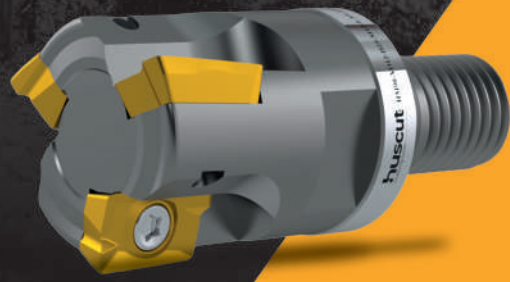
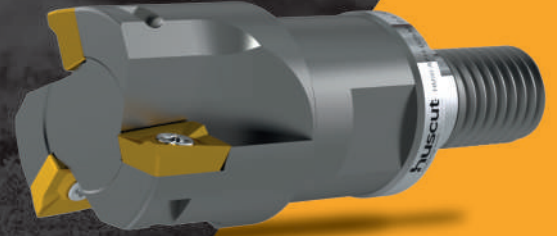

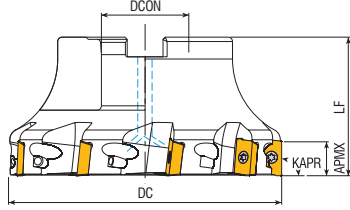
Perfect
Cut





KAPR=90°





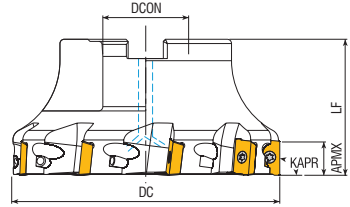

 Takım Kodu Ordering Code Bestell-Bezeichnung	Takım Ölçüleri (mm) Dimension (mm) Abmessung (mm)				Kesici Uç Insert Wendeschnei Platte	Sıkma Vidası Screw Schrauble	Anahtar Allen Key Torx Schlüssel
	DC	Z	DCON	LF			
HTM90-AP10-D040-A16-Z05-H	40	5	16	40	AP. 1003.	1060-M2.5x6	HTA-T08
HTM90-AP10-D050-A22-Z06-H	50	6	22	40			
HTM90-AP10-D063-A22-Z07-H	63	7	22	40			
HTM90-AP10-D080-A27-Z08-H	80	8	27	50			
HTM90-AP10-D100-A32-Z09-H	100	9	32	50			
HTM90-AP16-D040-A16-Z04-H	40	4	16	40	AP. 1604.	1060-M4x11	HTA-T15
HTM90-AP16-D050-A22-Z05-H	50	5	22	40			
HTM90-AP16-D063-A22-Z06-H	63	6	22	40			
HTM90-AP16-D080-A27-Z07-H	80	7	27	50			
HTM90-AP16-D100-A32-Z08-H	100	8	32	50			
HTM90-AP16-D125-B40-Z09	125	9	40	63			
HTM90-AP16-D160-C40-Z10	160	10	40	63			
HTM90-AP16-D200-C60-Z12	200	12	60	63			

ISO Compatible With



KAPR=90°



 Takım Kodu Ordering Code Bestell-Bezeichnung	Takım Ölçüleri (mm) Dimension (mm) Abmessung (mm)				Kesici Uç Insert Wendeschnei Platte	Sıkma Vidası Screw Schrauble	Anahtar Allen Key Torx Schlüssel
	DC	Z	DCON	LF			
HTM90-AP12-D040-A16-Z05-H	40	5	16	40	AP. 1204.	1070-M3.5x8	HTA-T15
HTM90-AP12-D050-A22-Z06-H	50	6	22	40			
HTM90-AP12-D063-A22-Z07-H	63	7	22	40			
HTM90-AP17-D050-A22-Z05-H	50	5	22	40	AP. 1705.	1060-M4x11	HTA-T15
HTM90-AP17-D063-A22-Z06-H	63	6	22	40			
HTM90-AP17-D080-A27-Z07-H	80	7	27	50			
HTM90-AP17-D100-A32-Z08-H	100	8	32	50			

T07C Compatible With

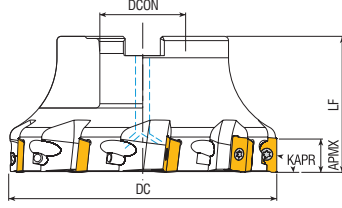

KAPR=90°



Takım Kodu
Ordering Code
Bestell-Bezeichnung

Takım Ölçüleri (mm)
Dimension (mm)
Abmessung (mm)

Kesici Uç
Insert
Wendeschnei Platte

Sıkma Vidası
Screw
Schraube

Anahtar
Allen Key
Torx Schlüssel

DC	Z	DCON	LF
40	5	16	40
50	6	22	40
63	7	22	40
80	8	27	50



APMT 11T3.

1060-M2.5x6

HTA-T08

KRIV Compatible With

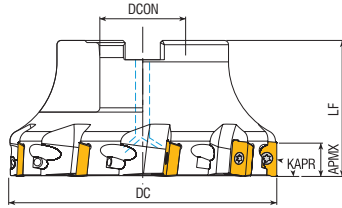

KAPR=90°



Takım Kodu
Ordering Code
Bestell-Bezeichnung

Takım Ölçüleri (mm)
Dimension (mm)
Abmessung (mm)

Kesici Uç
Insert
Wendeschnei Platte

Sıkma Vidası
Screw
Schraube

Anahtar
Allen Key
Torx Schlüssel

DC	Z	DCON	LF
40	5	16	40
50	6	22	40
63	7	22	40
80	8	27	50



APMT 1135.

1060-M2.5x6

HTA-T08

YG Compatible With

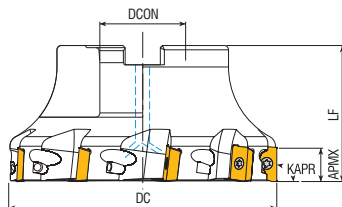

KAPR=90°

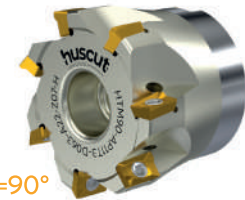

Takım Kodu
Ordering Code
Bestell-Bezeichnung

Takım Ölçüleri (mm)
Dimension (mm)
Abmessung (mm)

Kesici Uç
Insert
Wendeschnei Platte

Sıkma Vidası
Screw
Schraube

Anahtar
Allen Key
Torx Schlüssel

DC	Z	DCON	LF
40	5	16	40
50	6	22	40
63	7	22	40
80	8	27	50



AP. 11T3.





1060-M2.5x6

HTA-T08

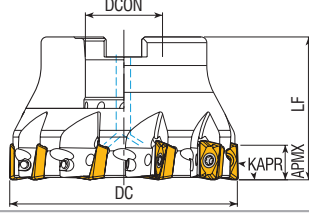
ZCC Compatible With









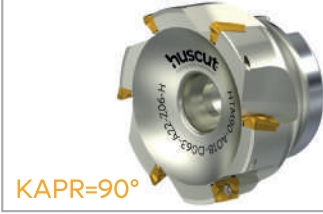
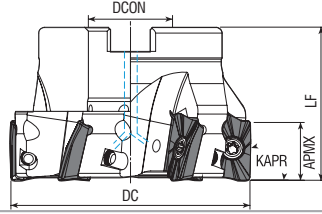

 Takım Kodu Ordering Code Bestell-Bezeichnung	Takım Ölçüleri (mm) Dimension (mm) Abmessung (mm)				Kesici Uç Insert Wendschnei Platte	Sıkma Vidası Screw Schraube	Anahtar Allen Key Torx Schlüssel
	DC	Z	DCON	LF			
HTM90-XO10-D040-A16-Z05-H	40	5	16	40	XO.10T3.	1060-M2.5x7	HTA-T08
HTM90-XO10-D040-A16-Z06-H	40	6	16	40			
HTM90-XO10-D050-A22-Z06-H	50	6	22	40			
HTM90-XO10-D050-A22-Z07-H	50	7	22	40			
HTM90-XO10-D063-A22-Z07-H	63	7	22	40			
HTM90-XO10-D063-A22-Z08-H	63	8	22	40			
HTM90-XO12-D040-A16-Z05-H	40	5	16	40	XO. 1204.	1070-M3.5x8	HTA-T15
HTM90-XO12-D050-A22-Z05-H	50	5	22	40			
HTM90-XO12-D050-A22-Z06-H	50	6	22	40			
HTM90-XO12-D063-A22-Z07-H	63	7	22	40			
HTM90-XO12-D063-A22-Z08-H	63	8	22	40			
HTM90-XO12-D080-A27-Z08-H	80	8	27	50			
HTM90-XO12-D080-A27-Z09-H	80	9	27	50			
HTM90-XO12-D100-A32-Z11-H	100	11	32	50			
HTM90-XO12-D125-B40-Z12-H	125	12	40	63			
HTM90-XO18-D050-A22-Z04-H	50	4	22	40	XO. 1806.	1060-M4.5x12	HTA-T20
HTM90-XO18-D063-A22-Z05-H	63	5	22	40			
HTM90-XO18-D080-A27-Z07-H	80	7	27	50			
HTM90-XO18-D100-A32-Z08-H	100	8	32	50			
HTM90-XO18-D125-B40-Z10-H	125	10	40	63			

SCD Compatible With









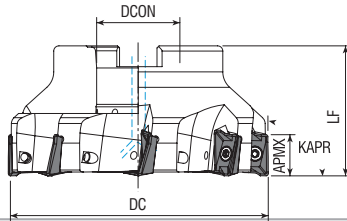

KAPR=90°

 Takım Kodu Ordering Code Bestell-Bezeichnung	Takım Ölçüleri (mm) Dimension (mm) Abmessung (mm)				Kesici Uç Insert Wendeschnei Platte	Sıkma Vidası Screw Schraube	Anahtar Allen Key Torx Schlüssel
	DC	Z	DCON	LF			
HTM90-AO12-D040-A16-Z05-H	40	5	16	40		1060-M2.5x6	HTA-T08
HTM90-AO12-D050-A22-Z06-H	50	6	22	40			
HTM90-AO12-D063-A22-Z07-H	63	7	22	40			
HTM90-AO18-D063-A22-Z06-H	63	6	22	40		1060-M4x11	HTA-T15
HTM90-AO18-D080-A27-Z07-H	80	7	27	50			
HTM90-AO18-D100-A32-Z08-H	100	8	32	50			

MTSBH Compatible With



KAPR=90°



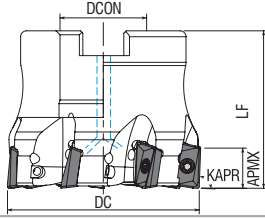

 Takım Kodu Ordering Code Bestell-Bezeichnung	Takım Ölçüleri (mm) Dimension (mm) Abmessung (mm)				Kesici Uç Insert Wendeschnei Platte	Sıkma Vidası Screw Schraube	Anahtar Allen Key Torx Schlüssel
	DC	Z	DCON	LF			
HTM90-AX1235-D040-A16-Z05-H	40	5	16	40		1070-M3x6.8	HTA-T08
HTM90-AX1235-D050-A22-Z06-H	50	6	22	40			
HTM90-AX1235-D063-A22-Z07-H	63	7	22	40			
HTM90-AX1705-D040-A16-Z04-H	40	4	16	40		1060-M4x11	HTA-T15
HTM90-AX1705-D050-A22-Z05-H	50	5	22	40			
HTM90-AX1705-D063-A22-Z06-H	63	6	22	40			
HTM90-AX1705-D080-A27-Z07-H	80	7	27	50			
HTM90-AX1705-D100-A32-Z08-H	100	8	32	50			

SMTM Compatible With



KAPR=90°



 Takım Kodu Ordering Code Bestell-Bezeichnung	Takım Ölçüleri (mm) Dimension (mm) Abmessung (mm)				Kesici Uç Insert Wendeschnei Platte	Sıkma Vidası Screw Schraube	Anahtar Allen Key Torx Schlüssel
	DC	Z	DCON	LF			
HTM90-AD10T3-D040-A16-Z05-H	40	5	16	40	ADMT 10T3.	1060-M2.5x6	HTA-T08
HTM90-AD10T3-D050-A22-Z06-H	50	6	22	40			
HTM90-AD10T3-D063-A22-Z07-H	63	7	22	40			
HTM90-AD1204-D040-A16-Z05-H	40	5	16	40	ADMT 1204.	1060-M3x8	HTA-T08
HTM90-AD1204-D050-A22-Z06-H	50	6	22	40			
HTM90-AD1204-D063-A22-Z07-H	63	7	22	40			
HTM90-AD1606-D050-A22-Z05-H	50	5	22	40	ADMT 1606.	1060-M4x11	HTA-T15
HTM90-AD1606-D063-A22-Z06-H	63	6	22	40			
HTM90-AD1606-D080-A27-Z07-H	80	7	27	50			
HTM90-AD1606-D100-A32-Z08-H	100	8	32	50			

KMT Compatible With

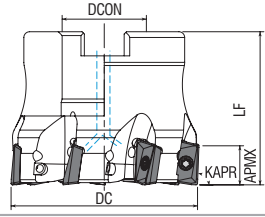

KAPR=90°



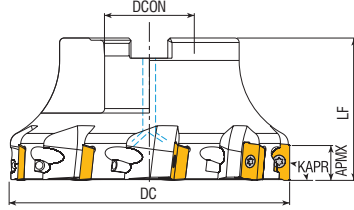

 Takım Kodu Ordering Code Bestell-Bezeichnung	Takım Ölçüleri (mm) Dimension (mm) Abmessung (mm)				Kesici Uç Insert Wendeschnei Platte	Sıkma Vidası Screw Schraube	Anahtar Allen Key Torx Schlüssel
	DC	Z	DCON	LF			
HTM90-ED10-D040-A16-Z05-H	40	5	16	40	EDPT 10T3.	1060-M2.5x6	HTA-T08
HTM90-ED10-D050-A22-Z06-H	50	6	22	40			
HTM90-ED10-D063-A22-Z07-H	63	7	22	40			
HTM90-ED14-D050-A22-Z05-H	50	5	22	40	EDPT 1404.	1060-M3x6	HTA-T08
HTM90-ED14-D063-A22-Z06-H	63	6	22	40			
HTM90-ED14-D080-A27-Z07-H	80	7	27	50			
HTM90-ED14-D100-A32-Z09-H	100	9	32	50			

KMT Compatible With



KAPR=90°





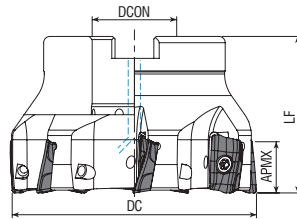

 Takım Kodu Ordering Code Bestell-Bezeichnung	Takım Ölçüleri (mm) Dimension (mm) Abmessung (mm)				Kesici Uç Insert Wendeschnei Platte	Sıkma Vidası Screw Schrauble	Anahtar Allen Key Torx Schlüssel
	DC	Z	DCON	LF			
HTM90-R390.11-D040-A16-Z05-H	40	5	16	40	R390-11T3.	1060-M2.5x6	HTA-T08
HTM90-R390.11-D050-A22-Z06-H	50	6	22	40			
HTM90-R390.11-D063-A22-Z07-H	63	7	22	40			
HTM90-R390.11-D080-A27-Z09-H	80	9	27	50			
HTM90-R390.17-D040-A16-Z04-H	40	4	16	40	R390-1704.	1060-M3.5x12	HTA-T15
HTM90-R390.17-D050-A22-Z05-H	50	5	22	40			
HTM90-R390.17-D063-A22-Z06-H	63	6	22	40			
HTM90-R390.17-D080-A27-Z07-H	80	7	27	50			
HTM90-R390.17-D100-A32-Z08-H	100	8	32	50	R390-1806.	1060-M4x11	HTA-T15
HTM90-R390.17-D125-B40-Z09	125	9	40	63			
HTM90-R390.18-D050-A22-Z04-H	50	4	22	40			
HTM90-R390.18-D063-A22-Z05-H	63	5	22	40			
HTM90-R390.18-D080-A27-Z06-H	80	6	27	50	R390-1806.	1060-M4x11	HTA-T15
HTM90-R390.18-D100-A32-Z07-H	100	7	32	50			
HTM90-R390.18-D125-B40-Z08	125	8	40	63			

SMDX Compatible With



KAPR=90°





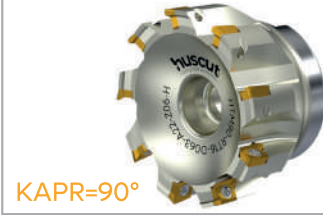
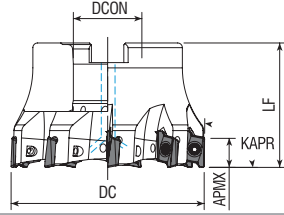

 Takım Kodu Ordering Code Bestell-Bezeichnung	Takım Ölçüleri (mm) Dimension (mm) Abmessung (mm)				Kesici Uç Insert Wendeschnei Platte	Sıkma Vidası Screw Schrauble	Anahtar Allen Key Torx Schlüssel
	DC	Z	DCON	LF			
HTM90-BD11T3-D040-A16-Z04-H	40	4	16	40	BDMT 11T3.	1060-M2.5x6	HTA-T08
HTM90-BD11T3-D040-A16-Z05-H	40	5	16	40			
HTM90-BD11T3-D050-A22-Z04-H	50	4	22	40			
HTM90-BD11T3-D050-A22-Z05-H	50	5	22	40			
HTM90-BD11T3-D063-A22-Z06-H	63	6	22	40	BDMT 1704.	1060-M4x11	HTA-T15
HTM90-BD1704-D050-A22-Z04-H	50	4	22	40			
HTM90-BD1704-D050-A22-Z05-H	50	5	22	40			
HTM90-BD1704-D063-A22-Z06-H	63	6	22	40			
HTM90-BD1704-D080-A27-Z07-H	80	7	27	50	BDMT 1704.	1060-M4x11	HTA-T15
HTM90-BD1704-D100-A32-Z08-H	100	8	32	50			

KVCB Compatible With







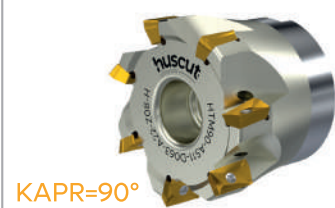
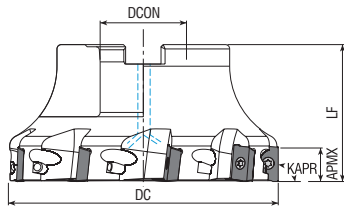

KAPR=90°

 Takım Kodu Ordering Code Bestell-Bezeichnung	Takım Ölçüleri (mm) Dimension (mm) Abmessung (mm)				Kesici Uç Insert Wendeschnei Platte	Sıkma Vidası Screw Schraube	Anahtar Allen Key Torx Schlüssel
	DC	Z	DCON	LF			
HTM90-RT10-D040-A16-Z06-H	40	6	16	40			
HTM90-RT10-D050-A22-Z07-H	50	7	22	40	RT1003	1060-M2.5x6	HTA-T08
HTM90-RT10-D063-A22-Z09-H	63	9	22	40			
HTM90-RT16-D040-A16-Z04-H	40	4	16	40			
HTM90-RT16-D050-A22-Z05-H	50	5	22	40			
HTM90-RT16-D063-A22-Z06-H	63	6	22	40	RT1606	1060-M4x11	HTA-T15
HTM90-RT16-D080-A27-Z07-H	80	7	27	50			
HTM90-RT16-D100-A32-Z08-H	100	8	32	50			
HTM90-RT16-D125-B40-Z09	125	9	40	63			

SFTY Compatible With





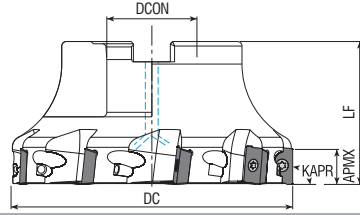

KAPR=90°

 Takım Kodu Ordering Code Bestell-Bezeichnung	Takım Ölçüleri (mm) Dimension (mm) Abmessung (mm)				Kesici Uç Insert Wendeschnei Platte	Sıkma Vidası Screw Schraube	Anahtar Allen Key Torx Schlüssel
	DC	Z	DCON	LF			
HTM90-AS11-D040-A16-Z06-H	40	6	16	40			
HTM90-AS11-D050-A22-Z07-H	50	7	22	40	AST11T3.	1060-M2.5x6	HTA-T08
HTM90-AS11-D063-A22-Z08-H	63	8	22	40			

TNGLY Compatible With





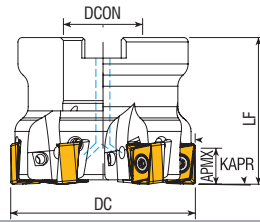

KAPR=90°

 Takım Kodu Ordering Code Bestell-Bezeichnung	Takım Ölçüleri (mm) Dimension (mm) Abmessung (mm)				Kesici Uç Insert Wendeschnei Platte	Sıkma Vidası Screw Schrauble	Anahtar Allen Key Torx Schlüssel
	DC	Z	DCON	LF			
HTM90-AD1505-D040-A16-Z04-H	40	4	16	40	AD.1505.	1060-M4x11	HTA-T15
HTM90-AD1505-D050-A22-Z05-H	50	5	22	40			
HTM90-AD1505-D063-A22-Z06-H	63	6	22	40			
HTM90-AD1505-D080-A27-Z07-H	80	7	27	50			
HTM90-AD1505-D100-A32-Z08-H	100	8	32	50			
HTM90-AD1505-D125-B40-Z09	125	9	40	63			

ISCR Compatible With





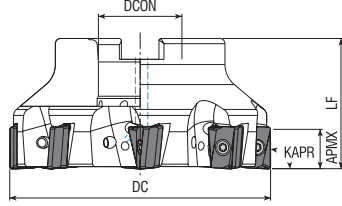

KAPR=90°

 Takım Kodu Ordering Code Bestell-Bezeichnung	Takım Ölçüleri (mm) Dimension (mm) Abmessung (mm)				Kesici Uç Insert Wendeschnei Platte	Sıkma Vidası Screw Schrauble	Anahtar Allen Key Torx Schlüssel
	DC	Z	DCON	LF			
HTM90-AN09-D040-A16-Z05-H	40	5	16	40	AN.X 0904.	1070-M3x6.8	HTA-T08
HTM90-AN09-D050-A22-Z06-H	50	6	22	40			
HTM90-AN09-D063-A22-Z08-H	63	8	22	50			
HTM90-AN12-D040-A16-Z04-H	40	4	16	40	AN.X 1205.	1060-M4x11	HTA-T15
HTM90-AN12-D050-A22-Z05-H	50	5	22	40			
HTM90-AN12-D063-A22-Z06-H	63	6	22	50			
HTM90-AN12-D080-A27-Z08-H	80	8	27	50			
HTM90-AN17-D050-A22-Z04-H	50	4	22	40	AN.X 1706.	1060-M5x14	HTA-T20
HTM90-AN17-D063-A22-Z06-H	63	6	22	50			
HTM90-AN17-D080-A27-Z07-H	80	7	27	50			
HTM90-AN17-D100-A32-Z08-H	100	8	32	50			
HTM90-AN17-D125-B40-Z10	125	10	40	63			

ISCR Compatible With





KAPR=90°

 Takım Kodu Ordering Code Bestell-Bezeichnung	Takım Ölçüleri (mm) Dimension (mm) Abmessung (mm)				Kesici Uç Insert Wendschnei Platte	Sıkma Vidası Screw Schraube	Anahtar Allen Key Torx Schlüssel
	DC	Z	DCON	LF			
HTM90-LN1006-D040-A16-Z05-H	40	5	16	40	LN.X 1006..	1060-M3x8	HTA-T08
HTM90-LN1006-D050-A22-Z06-H	50	6	22	40			
HTM90-LN1006-D063-A22-Z07-H	63	7	22	50			
HTM90-LN1510-D050-A22-Z05-H	50	5	22	40	LN.X 1510..	1060-M4x11	HTA-T15
HTM90-LN1510-D063-A22-Z06-H	63	6	22	50			
HTM90-LN1510-D080-A27-Z07-H	80	7	27	50			
HTM90-LN1510-D100-A32-Z09-H	100	9	32	50			
HTM90-LN1510-D125-B40-Z10	125	10	40	63			
HTM90-LN1510-D160-C40-Z12	160	12	40	63			

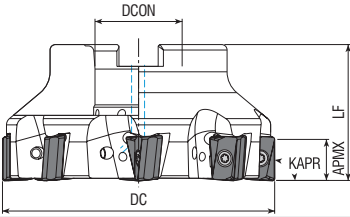
KRV Compatible With





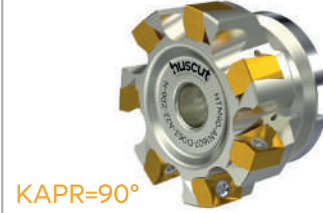
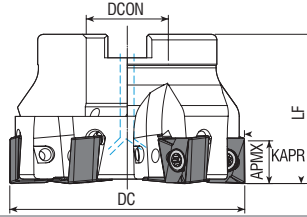

KAPR=90°

 Takım Kodu Ordering Code Bestell-Bezeichnung	Takım Ölçüleri (mm) Dimension (mm) Abmessung (mm)				Kesici Uç Insert Wendschnei Platte	Sıkma Vidası Screw Schraube	Anahtar Allen Key Torx Schlüssel
	DC	Z	DCON	LF			
HTM90-AN11-D040-A16-Z04-H	40	4	16	40	ANGX 1105..	1060-M3x8	HTA-T08
HTM90-AN11-D050-A22-Z05-H	40	5	22	40			
HTM90-AN11-D063-A22-Z06-H	40	6	22	40			
HTM90-AN1506-D050-A22-Z04-H	50	4	22	40	ANGX 1506..	1060-M4x11	HTA-T15
HTM90-AN1506-D063-A22-Z05-H	63	5	22	40			
HTM90-AN1506-D080-A27-Z06-H	80	6	27	50			
HTM90-AN1506-D100-A32-Z08-H	100	8	32	50			
HTM90-AN1506-D125-B40-Z09	125	9	40	63			
HTM90-AN1506-D160-C40-Z10	160	10	40	63			

ZCC Compatible With





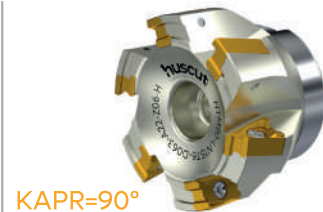
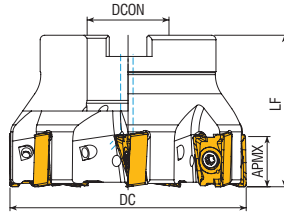

KAPR=90°

 Takım Kodu Ordering Code Bestell-Bezeichnung	Takım Ölçüleri (mm) Dimension (mm) Abmessung (mm)				Kesici Uç Insert Wendeschnei Platte	Sıkma Vidası Screw Schrauble	Anahtar Allen Key Torx Schlüssel
	DC	Z	DCON	LF			
HTM90-AN1607-D050-A22-Z04-H	50	4	22	40	AN.X1607.	1060-M4x11	HTA-T15
HTM90-AN1607-D063-A22-Z06-H	63	6	22	40			
HTM90-AN1607-D080-A27-Z07-H	80	7	27	50			
HTM90-AN1607-D100-A32-Z08-H	100	8	32	50			
HTM90-AN1607-D125-B40-Z10	125	10	40	63			

TGT-C Compatible With





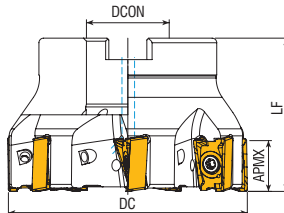

KAPR=90°

 Takım Kodu Ordering Code Bestell-Bezeichnung	Takım Ölçüleri (mm) Dimension (mm) Abmessung (mm)				Kesici Uç Insert Wendeschnei Platte	Sıkma Vidası Screw Schrauble	Anahtar Allen Key Torx Schlüssel
	DC	Z	DCON	LF			
HTM90-LN15T6-D050-A22-Z05-H	50	5	22	40	LNGU 15T6.	1070-M4x12	HTA-T15
HTM90-LN15T6-D063-A22-Z06-H	63	6	22	40			
HTM90-LN15T6-D080-A27-Z07-H	80	7	27	50			
HTM90-LN15T6-D100-A32-Z08-H	100	8	32	50			

KNMTL Compatible With



KAPR=90°

 Takım Kodu Ordering Code Bestell-Bezeichnung	Takım Ölçüleri (mm) Dimension (mm) Abmessung (mm)				Kesici Uç Insert Wendeschnei Platte	Sıkma Vidası Screw Schrauble	Anahtar Allen Key Torx Schlüssel
	DC	Z	DCON	LF			
HTM90-XN15T6-D050-A22-Z05-H	50	5	22	40	XNPU 15T6.	1070-M4x12	HTA-T15
HTM90-XN15T6-D063-A22-Z06-H	63	6	22	40			
HTM90-XN15T6-D080-A27-Z07-H	80	7	27	50			
HTM90-XN15T6-D100-A32-Z08-H	100	8	32	50			





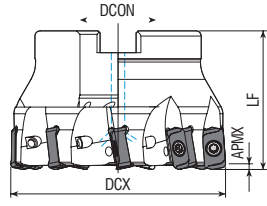





WDA Compatible With





KAPR=90°







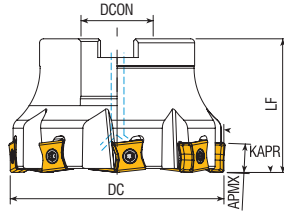



















 Takım Kodu Ordering Code Bestell-Bezeichnung	Takım Ölçüleri (mm) Dimension (mm) Abmessung (mm)				Kesici Uç Insert Wendeschnei Platte	Sıkma Vidası Screw Schrauble	Anahtar Allen Key Torx Schlüssel			
	DC	Z	DCON	LF						
HTM90-LM10-D040-A16-Z05-H	50	4	22	40						
HTM90-LM10-D050-A22-Z05-H	63	6	22	40				LOMU1004.	1070-M3x6.8	HTA-T08
HTM90-LM10-D063-A22-Z06-H	80	7	27	50						
HTM90-LM15-D050-A22-Z04-H	80	7	27	50	LOMU1505.	1070-M4x12	HTA-T15			
HTM90-LM15-D063-A22-Z05-H	100	8	32	50						
HTM90-LM15-D080-A27-Z06-H	125	9	40	63						

KPCR Compatible With



KAPR=90°



 Takım Kodu Ordering Code Bestell-Bezeichnung	Takım Ölçüleri (mm) Dimension (mm) Abmessung (mm)				Kesici Uç Insert Wendeschnei Platte	Sıkma Vidası Screw Schrauble	Anahtar Allen Key Torx Schlüssel			
	DC	Z	DCON	LF						
HTM90-LN08-D040-A16-Z05-H	40	5	16	40						
HTM90-LN08-D050-A22-Z06-H	50	6	22	40				LNMT 0804.	1060-M2.5x6	HTA-T08
HTM90-LN08-D063-A22-Z08-H	63	8	22	40						
HTM90-LN1106-D050-A22-Z05-H	50	5	22	40	T490 LNMT 1106.	1060-M3.5x12	HTA-T15			
HTM90-LN1106-D063-A22-Z06-H	63	6	22	40						
HTM90-LN1106-D080-A27-Z08-H	80	8	27	50						
HTM90-LN1106-D100-A32-Z09-H	100	9	32	50				T490 LNMT 1306.	1060-M4x11	HTA-T15
HTM90-LN1106-D125-B40-Z10	125	10	40	63						
HTM90-LN1306-D040-A16-Z04-H	40	4	16	40						
HTM90-LN1306-D050-A22-Z05-H	50	5	22	40				LNMT 1506.	1060-M4x11	HTA-T15
HTM90-LN1306-D063-A22-Z06-H	63	6	22	40						
HTM90-LN1306-D080-A27-Z07-H	80	7	27	50						
HTM90-LN1306-D100-A32-Z08-H	100	8	32	50				LNMT 1506.	1060-M4x11	HTA-T15
HTM90-LN1506-D040-A16-Z04-H	40	4	16	40						
HTM90-LN1506-D050-A22-Z05-H	50	5	22	40						
HTM90-LN1506-D063-A22-Z06-H	63	6	22	40				LNMT 1506.	1060-M4x11	HTA-T15
HTM90-LN1506-D080-A27-Z07-H	80	7	27	50						
HTM90-LN1607-D050-A22-Z03-H	50	3	22	40						
HTM90-LN1607-D063-A22-Z04-H	63	4	22	40				T490 LNMT 1607.	1070-M5x14	HTA-T20
HTM90-LN1607-D080-A27-Z05-H	80	5	27	50						
HTM90-LN1607-D100-A32-Z06-H	100	6	32	50						

ISCR Compatible With



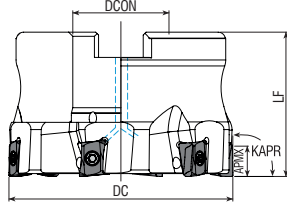





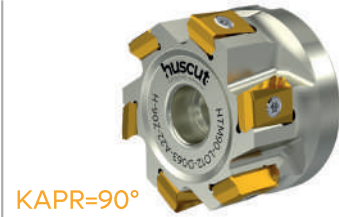
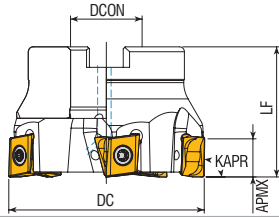

 Takım Kodu Ordering Code Bestell-Bezeichnung	Takım Ölçüleri (mm) Dimension (mm) Abmessung (mm)				Kesici Uç Insert Wendeschnei Platte	Sıkma Vidası Screw Schraube	Anahtar Allen Key Torx Schlüssel
	DC	Z	DCON	LF			
HTM90-LX08-D040-A16-Z06-H	40	6	16	40	 LOEX 0804.	 1060-M2.5x7	 HTA-T08
HTM90-LX08-D050-A22-Z07-H	50	7	22	40			
HTM90-LX08-D063-A22-Z08-H	63	8	22	40			
HTM90-LX12-D050-A22-Z05-H	50	5	22	40	 LOEX 1207.	 1060-M3.5x12	 HTA-T15
HTM90-LX12-D063-A22-Z06-H	63	6	22	40			
HTM90-LX12-D080-A27-Z07-H	80	7	27	50			
HTM90-LX12-D100-A32-Z09-H	100	9	32	50			

SCD Compatible With





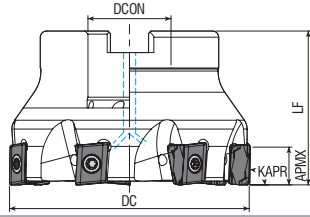

 Takım Kodu Ordering Code Bestell-Bezeichnung	Takım Ölçüleri (mm) Dimension (mm) Abmessung (mm)				Kesici Uç Insert Wendeschnei Platte	Sıkma Vidası Screw Schraube	Anahtar Allen Key Torx Schlüssel
	DC	Z	DCON	LF			
HTM90-LO09-D040-A16-Z05-H	40	5	16	40	 LOGU 0904.	 1060-M2.5x6	 HTA-T08
HTM90-LO09-D050-A22-Z06-H	50	6	22	40			
HTM90-LO09-D063-A22-Z07-H	63	7	22	40			
HTM90-LO12-D040-A16-Z04-H	40	4	16	40	 LOGU 1207.	 1070-M4x12	 HTA-T15
HTM90-LO12-D050-A22-Z05-H	50	5	22	40			
HTM90-LO12-D063-A22-Z06-H	63	6	22	40			
HTM90-LO12-D080-A27-Z07-H	80	7	27	50			
HTM90-LO12-D100-A32-Z07-H	100	7	32	50			

MTSBI Compatible With





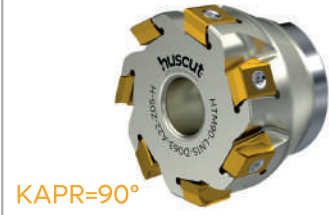
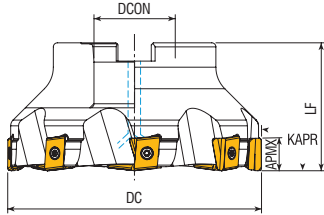

KAPR=90°

 Takım Kodu Ordering Code Bestell-Bezeichnung	Takım Ölçüleri (mm) Dimension (mm) Abmessung (mm)				Kesici Uç Insert Wendeschnei Platte	Sıkma Vidası Screw Schraube	Anahtar Allen Key Torx Schlüssel
	DC	Z	DCON	LF			
HTM90-LH09-D040-A16-Z05-H	40	5	16	40	LNHU 0904.	1060-M3x8	HTA-T08
HTM90-LH09-D050-A22-Z06-H	50	6	22	40			
HTM90-LH09-D063-A22-Z07-H	63	7	22	40			
HTM90-LH09-D080-A27-Z09-H	80	9	27	50			
HTM90-LH13-D040-A16-Z04-H	40	4	16	40	LNHU 1307.	1060-M4x11	HTA-T15
HTM90-LH13-D050-A22-Z05-H	50	5	22	40			
HTM90-LH13-D063-A22-Z06-H	63	6	22	40			
HTM90-LH13-D080-A27-Z07-H	80	7	27	50			
HTM90-LH13-D100-A32-Z09-H	100	9	32	50			

WTR Compatible With



KAPR=90°

 Takım Kodu Ordering Code Bestell-Bezeichnung	Takım Ölçüleri (mm) Dimension (mm) Abmessung (mm)				Kesici Uç Insert Wendeschnei Platte	Sıkma Vidası Screw Schraube	Anahtar Allen Key Torx Schlüssel
	DC	Z	DCON	LF			
HTM90-LN15-D050-A22-Z04-H	50	4	22	40	LNKT 1506.	1060-M4x11	HTA-T15
HTM90-LN15-D063-A22-Z05-H	63	5	22	40			
HTM90-LN15-D080-A27-Z06-H	80	6	27	50			
HTM90-LN15-D100-A32-Z07-H	100	7	32	50			
HTM90-LN15-D125-B40-Z08	125	8	40	63			



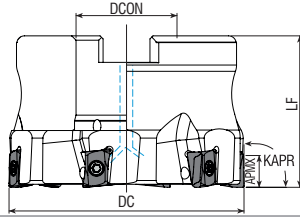

ZCC Compatible With



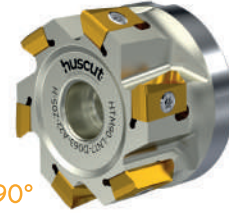

KAPR=90°





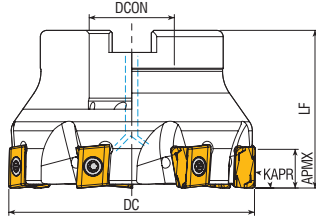

 Takım Kodu Ordering Code Bestell-Bezeichnung	Takım Ölçüleri (mm) Dimension (mm) Abmessung (mm)				Kesici Uç Insert Wendeschnei Platte	Sıkma Vidası Screw Schrauble	Anahtar Allen Key Torx Schlüssel
	DC	Z	DCON	LF			
HTM90-LN17-D050-A22-Z05-H	50	5	22	40	LNKT 1707..	1070-M4x12	HTA-T15
HTM90-LN17-D063-A22-Z06-H	63	6	22	40			
HTM90-LN17-D080-A27-Z07-H	80	7	27	50			
HTM90-LN17-D100-A32-Z09-H	100	9	32	50			
HTM90-LN17-D125-B40-Z010	125	10	40	63			

KRIV Compatible With



KAPR=90°





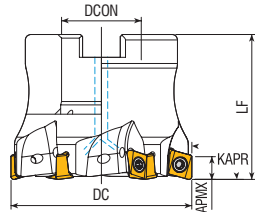

 Takım Kodu Ordering Code Bestell-Bezeichnung	Takım Ölçüleri (mm) Dimension (mm) Abmessung (mm)				Kesici Uç Insert Wendeschnei Platte	Sıkma Vidası Screw Schrauble	Anahtar Allen Key Torx Schlüssel
	DC	Z	DCON	LF			
HTM90-LP09-D040-A16-Z05-H	40	5	16	40	LPU 0904..	1060-M3x8	HTA-T08
HTM90-LP09-D050-A22-Z06-H	50	6	22	40			
HTM90-LP09-D063-A22-Z07-H	63	7	22	40			

TETC Compatible With



KAPR=90°





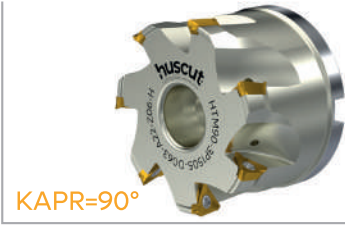
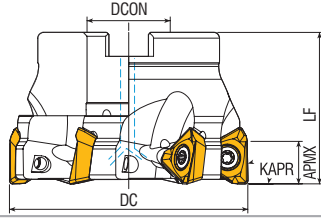

 Takım Kodu Ordering Code Bestell-Bezeichnung	Takım Ölçüleri (mm) Dimension (mm) Abmessung (mm)				Kesici Uç Insert Wendeschnei Platte	Sıkma Vidası Screw Schrauble	Anahtar Allen Key Torx Schlüssel
	DC	Z	DCON	LF			
HTM90-4N06-D040-A16-Z05-H	40	5	16	40	4NKT 0603..	1070-M3x6.8	HTA-T08
HTM90-4N06-D050-A22-Z06-H	50	6	22	40			
HTM90-4N06-D063-A22-Z07-H	63	7	22	40			

TETC Compatible With





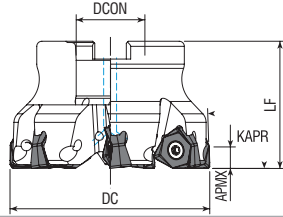

KAPR=90°

 Takım Kodu Ordering Code Bestell-Bezeichnung	Takım Ölçüleri (mm) Dimension (mm) Abmessung (mm)				Kesici Uç Insert Wendeschnei Platte	Sıkma Vidası Screw Schraube	Anahtar Allen Key Torx Schlüssel
	DC	Z	DCON	LF			
HTM90-3P1004-D040-A16-Z05-H	40	5	16	40	3PT 1004	1060-M3x8	HTA-T08
HTM90-3P1004-D050-A22-Z06-H	50	6	22	40			
HTM90-3P1004-D063-A22-Z07-H	63	7	22	40			
HTM90-3P1505-D050-A22-Z05-H	50	5	22	40	3PT 1505	1075-M4x11	HTA-T15
HTM90-3P1505-D063-A22-Z06-H	63	6	22	40			
HTM90-3P1505-D080-A27-Z07-H	80	7	27	50			
HTM90-3P1505-D100-A32-Z08-H	100	8	32	50			
HTM90-3P1505-D125-B40-Z10	125	10	40	63			

T07C Compatible With



KAPR=90°



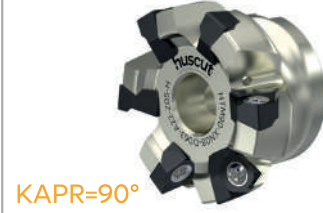
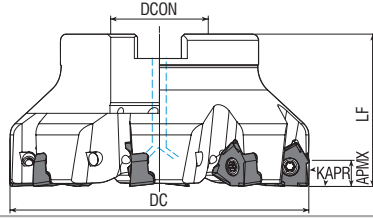

 Takım Kodu Ordering Code Bestell-Bezeichnung	Takım Ölçüleri (mm) Dimension (mm) Abmessung (mm)				Kesici Uç Insert Wendeschnei Platte	Sıkma Vidası Screw Schraube	Anahtar Allen Key Torx Schlüssel
	DC	Z	DCON	LF			
HTM90-WN08-D050-A22-Z04-H	50	4	22	40	WN. 0806.	1060-M5x14	HTA-T20
HTM90-WN08-D063-A22-Z05-H	63	5	22	40			
HTM90-WN08-D080-A27-Z07-H	80	7	27	50			
HTM90-WN08-D100-A32-Z08-H	100	8	32	50			
HTM90-WN08-D125-B40-Z10	125	10	40	63			
HTM90-WN08-D160-C40-Z12	160	12	40	63			

K08C Compatible With







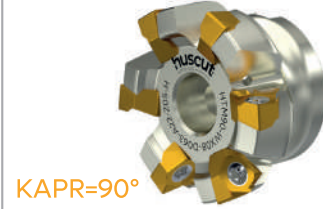
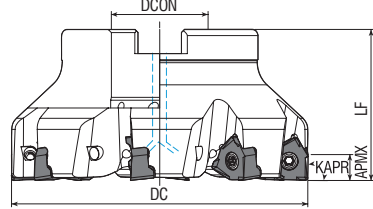

KAPR=90°

 Takım Kodu Ordering Code Bestell-Bezeichnung	Takım Ölçüleri (mm) Dimension (mm) Abmessung (mm)				Kesici Uç Insert Wendeschnei Platte	Sıkma Vidası Screw Schraube	Anahtar Allen Key Torx Schlüssel
	DC	Z	DCON	LF			
HTM90-XN08-D050-A22-Z04-H	50	4	22	40	XNEX 0806.	1060-M4x11	HTA-T15
HTM90-XN08-D063-A22-Z05-H	63	5	22	40			
HTM90-XN08-D080-A27-Z07-H	80	7	27	50			
HTM90-XN08-D100-A32-Z08-H	100	8	32	50			
HTM90-XN08-D125-B40-Z10	125	10	40	63			

SCD Compatible With





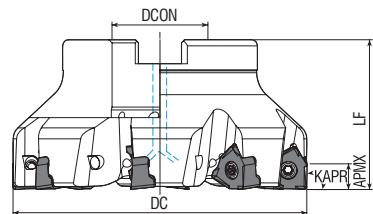

KAPR=90°

 Takım Kodu Ordering Code Bestell-Bezeichnung	Takım Ölçüleri (mm) Dimension (mm) Abmessung (mm)				Kesici Uç Insert Wendeschnei Platte	Sıkma Vidası Screw Schraube	Anahtar Allen Key Torx Schlüssel
	DC	Z	DCON	LF			
HTM90-WX08-D050-A22-Z04-H	50	4	22	40	WNGX 0806.	1060-M5x14	HTA-T20
HTM90-WX08-D063-A22-Z05-H	63	5	22	40			
HTM90-WX08-D080-A27-Z06-H	80	6	27	50			
HTM90-WX08-D100-A32-Z08-H	100	8	32	50			
HTM90-WX08-D125-B40-Z10	125	10	40	63			

KRV Compatible With





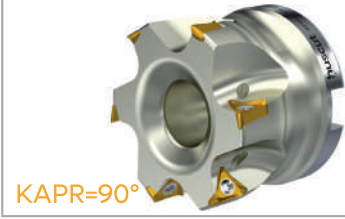
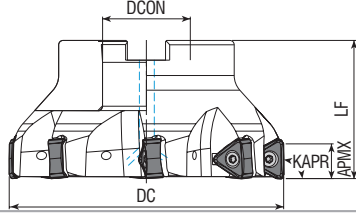

KAPR=90°

 Takım Kodu Ordering Code Bestell-Bezeichnung	Takım Ölçüleri (mm) Dimension (mm) Abmessung (mm)				Kesici Uç Insert Wendeschnei Platte	Sıkma Vidası Screw Schraube	Anahtar Allen Key Torx Schlüssel
	DC	Z	DCON	LF			
HTM90-WH08-D050-A22-Z04-H	50	4	22	40	WNHU 0806.	1060-M4x11	HTA-T15
HTM90-WH08-D063-A22-Z05-H	63	5	22	40			
HTM90-WH08-D080-A27-Z06-H	80	6	27	50			
HTM90-WH08-D100-A32-Z08-H	100	8	32	50			
HTM90-WH08-D125-B40-Z10	125	10	40	63			

ZCC Compatible With





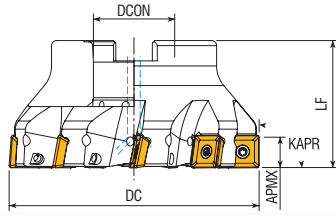

KAPR=90°

 Takım Kodu Ordering Code Bestell-Bezeichnung	Takım Ölçüleri (mm) Dimension (mm) Abmessung (mm)				Kesici Uç Insert Wendeschnei Platte	Sıkma Vidası Screw Schraube	Anahtar Allen Key Torx Schlüssel
	DC	Z	DCON	LF			
HTM90-TN10-D040-A16-Z04-H	40	4	16	40	TNGX 1004.	1060-M2.5x7	HTA-T08
HTM90-TN10-D050-A22-Z05-H	50	5	22	40			
HTM90-TN10-D063-A22-Z06-H	63	6	22	40			
HTM90-TN10-D080-A27-Z08-H	80	8	27	50			
HTM90-TN16-D040-A16-Z03-H	40	3	16	40	TNGX 1606.	1070-M4x12	HTA-T15
HTM90-TN16-D050-A22-Z04-H	50	4	22	40			
HTM90-TN16-D063-A22-Z05-H	63	5	22	40			
HTM90-TN16-D080-A27-Z07-H	80	7	27	50			
HTM90-TN16-D100-A32-Z08-H	100	8	32	50			
HTM90-TN16-D125-B40-Z09-H	125	9	40	63			

P8MT Compatible With



KAPR=90°



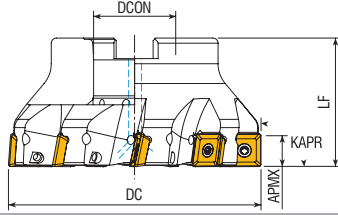

 Takım Kodu Ordering Code Bestell-Bezeichnung	Takım Ölçüleri (mm) Dimension (mm) Abmessung (mm)				Kesici Uç Insert Wendeschnei Platte	Sıkma Vidası Screw Schraube	Anahtar Allen Key Torx Schlüssel
	DC	Z	DCON	LF			
HTM90-R290.12-D050-A22-Z04-H	50	4	22	40	R290-12T3.	1060-M3.5x12	HTA-T15
HTM90-R290.12-D063-A22-Z05-H	63	5	22	40			
HTM90-R290.12-D080-A27-Z07-H	80	7	27	50			
HTM90-R290.12-D100-A32-Z09-H	100	9	32	50			
HTM90-R290.12-D125-B40-Z11	125	11	40	63			

SNDV/K Compatible With



KAPR=90°



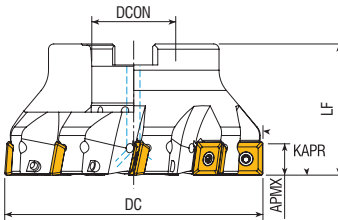

 Takım Kodu Ordering Code Bestell-Bezeichnung	Takım Ölçüleri (mm) Dimension (mm) Abmessung (mm)				Kesici Uç Insert Wendeschnei Platte	Sıkma Vidası Screw Schrauble	Anahtar Allen Key Torx Schlüssel
	DC	Z	DCON	LF			
HTM90-490R08-D040-A16-Z04-H	40	4	16	40	490R-08T3.	1060-M2.5x7	HTA-T08
HTM90-490R08-D050-A22-Z05-H	50	5	22	40			
HTM90-490R08-D063-A22-Z06-H	63	6	22	40			
HTM90-490R14-D050-A22-Z04-H	50	4	22	40			
HTM90-490R14-D063-A22-Z05-H	63	5	22	40	490R-1404.	1060-M3.5x12	HTA-T15
HTM90-490R14-D080-A27-Z07-H	80	7	27	50			
HTM90-490R14-D100-A32-Z07-H	100	7	32	50			
HTM90-490R14-D125-B40-Z08	125	8	40	63			
HTM90-490R14-D160-C40-Z12	160	12	40	63			
HTM90-490R14-D200-C60-Z16	200	16	60	63			

SMD/Compatible With



KAPR=90°



 Takım Kodu Ordering Code Bestell-Bezeichnung	Takım Ölçüleri (mm) Dimension (mm) Abmessung (mm)				Kesici Uç Insert Wendeschnei Platte	Sıkma Vidası Screw Schrauble	Anahtar Allen Key Torx Schlüssel
	DC	Z	DCON	LF			
HTM90-SE09-D040-A16-Z04-H	40	4	16	40	SEET 09T3.	1060-M3x8	HTA-T08
HTM90-SE09-D050-A22-Z05-H	50	5	22	40			
HTM90-SE09-D063-A22-Z06-H	63	6	22	40			
HTM90-SE12-D050-A22-Z04-H	50	4	22	40	SEET 1203.	1060-M3.5x12	HTA-T15
HTM90-SE12-D063-A22-Z05-H	63	5	22	40			
HTM90-SE12-D080-A27-Z07-H	80	7	27	50			
HTM90-SE12-D100-A32-Z09-H	100	9	32	50			
HTM90-SE12-D125-B40-Z11	125	11	40	63			

ZCC Compatible With

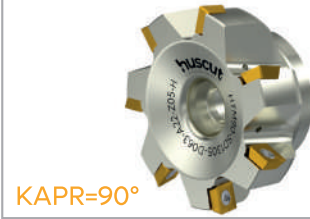
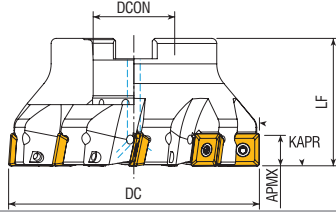

KAPR=90°

 Takım Kodu Ordering Code Bestell-Bezeichnung	Takım Ölçüleri (mm) Dimension (mm) Abmessung (mm)				Kesici Uç Insert Wendeschnei Platte	Sıkma Vidası Screw Schrauble	Anahtar Allen Key Torx Schlüssel
	DC	Z	DCON	LF			
HTM90-SD09M4-D040-A16-Z04-H	40	4	16	40	SD.09M4..	1060-M3.5x12	HTA-T15
HTM90-SD09M4-D050-A22-Z05-H	50	5	22	40			
HTM90-SD09M4-D063-A22-Z06-H	63	6	22	40			
HTM90-SD09M4-D080-A27-Z07-H	80	7	27	50			
HTM90-SD1305-D050-A22-Z04-H	50	4	22	40	SD.1305..	1060-M5x14	HTA-T20
HTM90-SD1305-D063-A22-Z05-H	63	5	22	40			
HTM90-SD1305-D080-A27-Z06-H	80	6	27	50			
HTM90-SD1305-D100-A32-Z07-H	100	7	32	50			
HTM90-SD1305-D125-B40-Z08	125	8	40	63			
HTM90-SD1305-D160-C40-Z10	160	10	40	63			

KRV Compatible With

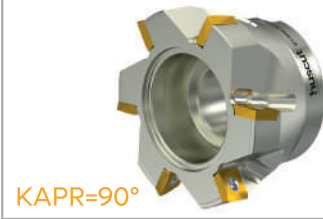
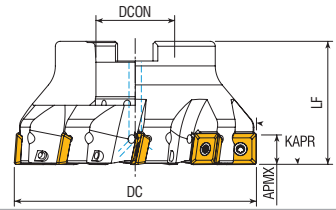

KAPR=90°

 Takım Kodu Ordering Code Bestell-Bezeichnung	Takım Ölçüleri (mm) Dimension (mm) Abmessung (mm)				Kesici Uç Insert Wendeschnei Platte	Sıkma Vidası Screw Schrauble	Anahtar Allen Key Torx Schlüssel
	DC	Z	DCON	LF			
HTM90-SO12-D050-A22-Z04-H	50	4	22	40	SOMT 12T3..	1060-M4x11	HTA-T15
HTM90-SO12-D063-A22-Z05-H	63	5	22	40			
HTM90-SO12-D080-A27-Z06-H	80	6	27	50			

MTSBH Compatible With

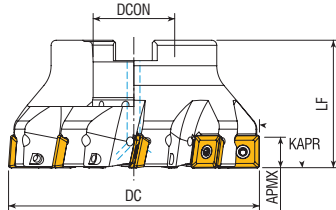

KAPR=90°



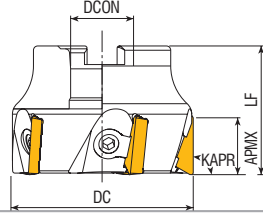

 Takım Kodu Ordering Code Bestell-Bezeichnung	Takım Ölçüleri (mm) Dimension (mm) Abmessung (mm)				Kesici Uç Insert Wendeschnei Platte	Sıkma Vidası Screw Schrauble	Anahtar Allen Key Torx Schlüssel
	DC	Z	DCON	LF			
HTM90-SE1304-D050-A22-Z04-H	50	4	22	40	SEMT 1304..	1060-M4x11	HTA-T15
HTM90-SE1304-D063-A22-Z05-H	63	5	22	40			
HTM90-SE1304-D080-A27-Z06-H	80	6	27	50			

TGT Compatible With

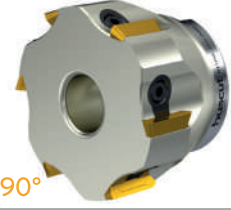

KAPR=90°





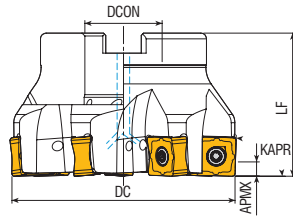

 Takım Kodu Ordering Code Bestell-Bezeichnung	Takım Ölçüleri (mm) Dimension (mm) Abmessung (mm)				Kesici Uç Insert Wendeschneidplatte	Sıkma Vidası Screw Schraube	Baskı Pabucu Wedge Clamp Spannpratze	Anahtar Allen Key Torx Schlüssel
	DC	Z	DCON	LF				
HTM90C-TP16-D050-A22-Z04	50	4	22	40	TP.1603.	HPV-20-M8x1x18	HBP-20	HAL-04
HTM90C-TP16-D063-A22-Z06	63	6	22	45				
HTM90C-TP16-D080-A27-Z07	80	7	27	50				
HTM90C-TP16-D100-A32-Z08	100	8	32	50				
HTM90C-TP16-D125-B40-Z08	125	8	40	63	TP.2204.	HPV-20-M8x1x18	HBP-20	HAL-04
HTM90C-TP22-D063-A22-Z05	63	5	22	45				
HTM90C-TP22-D080-A27-Z06	80	6	27	50				
HTM90C-TP22-D100-A32-Z07	100	7	32	50				
HTM90C-TP22-D125-B40-Z08	125	8	40	63				
HTM90C-TP22-D160-C40-Z09	160	9	40	63				
HTM90C-TP22-D200-C60-Z12	200	12	60	63				
HTM90C-TP22-D250-C60-Z15	250	15	60	63				
HTM90C-TP22-D315-D60-Z18	315	18	60	63				

ISO Compatible With



KAPR=88°





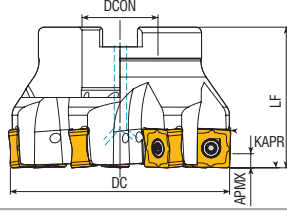

 Takım Kodu Ordering Code Bestell-Bezeichnung	Takım Ölçüleri (mm) Dimension (mm) Abmessung (mm)				Kesici Uç Insert Wendeschneidplatte	Sıkma Vidası Screw Schraube	Anahtar Allen Key Torx Schlüssel
	DC	Z	DCON	LF			
HTM88-SN1206-D040-A22-Z04-H	40	4	22	40	SN.1206.	1060-M4x11	HTA-T15
HTM88-SN1206-D050-A22-Z05-H	50	5	22	40			
HTM88-SN1206-D063-A22-Z06-H	63	6	22	40			
HTM88-SN1206-D080-A27-Z07-H	80	7	27	50			
HTM88-SN1206-D100-A32-Z09-H	100	9	32	50			
HTM88-SN1206-D125-B40-Z10-H	125	10	40	63			
HTM88-SN1206-D160-C40-Z11-H	160	11	40	63			
HTM88-SN1206-D200-C60-Z14-H	200	14	60	63			

KR15 Compatible With



KAPR=88°





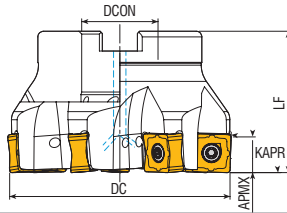

 Takım Kodu Ordering Code Bestell-Bezeichnung	Takım Ölçüleri (mm) Dimension (mm) Abmessung (mm)				Kesici Uç Insert Wendeschnei Platte	Sıkma Vidası Screw Schraube	Anahtar Allen Key Torx Schlüssel
	DC	Z	DCON	LF			
HTM88-SN12.-D040-A22-Z04-H	40	4	22	40	SN. 12.	1080-M4x11	HTA-T15
HTM88-SN12.-D050-A22-Z05-H	50	5	22	40			
HTM88-SN12.-D063-A22-Z06-H	63	6	22	40			
HTM88-SN12.-D080-A27-Z07-H	80	7	27	50			
HTM88-SN12.-D100-A32-Z09-H	100	9	32	50			
HTM88-SN12.-D125-B40-Z10-H	125	10	40	63			
HTM88-SN12.-D160-C40-Z11-H	160	11	40	63			
HTM88-SN12.-D200-C60-Z14-H	200	14	60	63			

ISO Compatible With



KAPR=88°





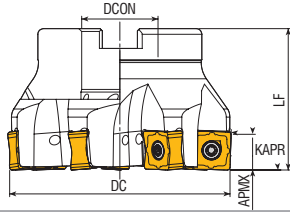

 Takım Kodu Ordering Code Bestell-Bezeichnung	Takım Ölçüleri (mm) Dimension (mm) Abmessung (mm)				Kesici Uç Insert Wendeschnei Platte	Sıkma Vidası Screw Schraube	Anahtar Allen Key Torx Schlüssel
	DC	Z	DCON	LF			
HTM89-SN13-D050-A22-Z05-H	50	5	22	40	"SNMU1305. OXMT 0507."	1080-M4x11	HTA-T15
HTM89-SN13-D063-A22-Z06-H	63	6	22	40			
HTM89-SN13-D080-A27-Z08-H	80	8	27	50			
HTM89-SN13-D100-A32-Z10-H	100	10	32	50			
HTM89-SN13-D125-B40-Z11-H	125	11	40	63			

ISO Compatible With



KAPR=88°





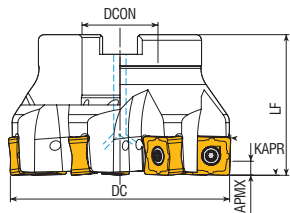

 Takım Kodu Ordering Code Bestell-Bezeichnung	Takım Ölçüleri (mm) Dimension (mm) Abmessung (mm)				Kesici Uç Insert Wendeschnei Platte	Sıkma Vidası Screw Schrauble	Anahtar Allen Key Torx Schlüssel
	DC	Z	DCON	LF			
HTM88-SN1305-D050-A22-Z04	50	4	22	40	SNMU 1305..	1060-M4x11	HTA-T15
HTM88-SN1305-D050-A22-Z05	50	5	22	40			
HTM88-SN1305-D063-A22-Z05	63	5	22	40			
HTM88-SN1305-D063-A22-Z06	63	6	22	40			
HTM88-SN1305-D080-A27-Z07	80	7	27	50			
HTM88-SN1305-D080-A27-Z09	80	9	27	50			
HTM88-SN1305-D100-A32-Z09	100	9	32	50			
HTM88-SN1305-D100-A32-Z11	100	11	32	50			
HTM88-SN1305-D125-B40-Z13	125	13	40	63			

KYCR Compatible With



KAPR=88°



 Takım Kodu Ordering Code Bestell-Bezeichnung	Takım Ölçüleri (mm) Dimension (mm) Abmessung (mm)				Kesici Uç Insert Wendeschnei Platte	Sıkma Vidası Screw Schrauble	Anahtar Allen Key Torx Schlüssel
	DC	Z	DCON	LF			
HTM88-SN1306-D050-A22-Z05-H	50	5	22	40	SNGX 1306..	1070-M4x12	HTA-T15
HTM88-SN1306-D063-A22-Z06-H	63	6	22	40			
HTM88-SN1306-D080-A27-Z07-H	80	7	27	50			
HTM88-SN1306-D100-A32-Z9-H	100	9	32	50			

TGTC Compatible With

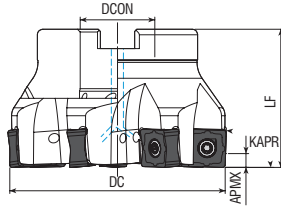

KAPR=88°



Takım Kodu Ordering Code Bestell-Bezeichnung	Takım Ölçüleri (mm) Dimension (mm) Abmessung (mm)				Kesici Uç Insert Wendeschnei Platte	Sıkma Vidası Screw Schraube	Anahtar Allen Key Torx Schlüssel
	DC	Z	DCON	LF			
HTM88-SN1205-D050-A22-Z05-H	50	5	22	40	SNEG 1205..	1060-M4x11	HTA-T15
HTM88-SN1205-D063-A22-Z06-H	63	6	22	40			
HTM88-SN1205-D080-A27-Z07-H	80	7	27	50			
HTM88-SN1205-D100-A32-Z09-H	100	9	32	50			

ZCC Compatible With

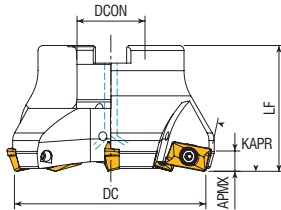

KAPR=75°

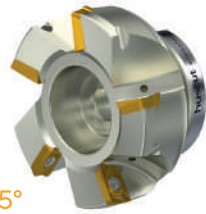

Takım Kodu Ordering Code Bestell-Bezeichnung	Takım Ölçüleri (mm) Dimension (mm) Abmessung (mm)				Kesici Uç Insert Wendeschnei Platte	Sıkma Vidası Screw Schraube	Anahtar Allen Key Torx Schlüssel
	DC	Z	DCON	LF			
HTM75-AP16-D063-A22-Z04-H	63	4	22	40	AP. 1604..	1060-M4x11	HTA-T15
HTM75-AP16-D080-A27-Z05-H	80	5	27	50			
HTM75-AP16-D100-A32-Z06-H	100	6	32	50			
HTM75-AP16-D125-B40-Z07	125	7	40	63			

ISO Compatible With

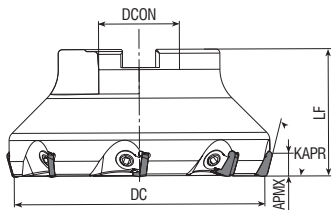

KAPR=75°





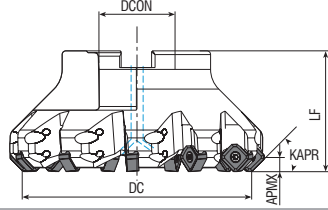

Takım Kodu Ordering Code Bestell-Bezeichnung	Takım Ölçüleri (mm) Dimension (mm) Abmessung (mm)				Kesici Uç Insert Wendeschnei Platte	Sıkma Vidası Screw Schraube	Baskı Pabucu Wedge Clamp Spannpratze	Anahtar Allen Key Torx Schlüssel
	DC	Z	DCON	LF				
HTM75C-SP12-D050-A22-Z04	50	4	22	42	SPKN1203..	HPV-20-M8x1x18	HBP-20	HAL-04
HTM75C-SP12-D063-A22-Z05	63	5	22	40				
HTM75C-SP12-D080-A27-Z06	80	6	27	50				
HTM75C-SP12-D100-A32-Z07	100	7	32	50				
HTM75C-SP12-D125-B40-Z08	125	8	40	63				
HTM75C-SP12-D160-C40-Z09	160	9	40	63				
HTM75C-SP12-D200-C60-Z12	200	12	60	63				

ISO Compatible With



KAPR=45°

 Takım Kodu Ordering Code Bestell-Bezeichnung	Takım Ölçüleri (mm) Dimension (mm) Abmessung (mm)				Kesici Uç Insert Wendschnei Platte	Sıkma Vidası Screw Schraube	Anahtar Allen Key Torx Schlüssel
	DC	Z	DCON	LF			
HTM45-SN1206-D050-A22-Z04-H	50	4	22	42	SN.1206.	1060-M4x11	HTA-T15
HTM45L-SN1206-D050-A22-Z05-H	50	5	22	42			
HTM45-SN1206-D050-A22-Z05-H	50	5	22	42			
HTM45-SN1206-D063-A22-Z06-H	63	6	22	42			
HTM45-SN1206-D063-A22-Z07-H	63	7	22	42			
HTM45L-SN1206-D063-A22-Z07-H	63	7	22	42			
HTM45-SN1206-D080-A27-Z07-H	80	7	27	52			
HTM45-SN1206-D080-A27-Z08-H	80	8	27	52			
HTM45L-SN1206-D080-A27-Z08-H	80	8	27	52			
HTM45-SN1206-D100-A32-Z08-H	100	8	32	52			
HTM45-SN1206-D100-A32-Z10-H	100	10	32	52			
HTM45L-SN1206-D100-A32-Z10-H	100	10	32	52			
HTM45-SN1206-D125-B40-Z11	125	11	40	65			
HTM45L-SN1206-D125-B40-Z11	125	11	40	65			
HTM45-SN1206-D160-C40-Z12	160	12	40	65			
HTM45L-SN1206-D160-C40-Z12	160	12	40	65			
HTM45-SN1206-D200-C60-Z14	200	14	60	65			
HTM45L-SN1206-D200-C60-Z14	200	14	60	65			



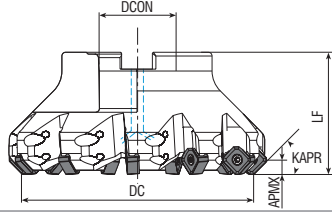

KRIV Compatible With





KAPR=45°





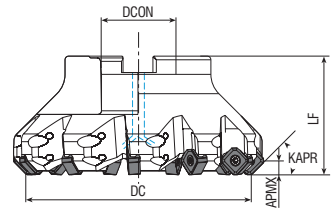

 Takım Kodu Ordering Code Bestell-Bezeichnung	Takım Ölçüleri (mm) Dimension (mm) Abmessung (mm)				Kesici Uç Insert Wendeschnei Platte	Sıkma Vidası Screw Schraube	Anahtar Allen Key Torx Schlüssel
	DC	Z	DCON	LF			
HTM45-SN12.-D050-A22-Z04-H	50	4	22	42	SN. 12.	1080-M4x11	HTA-T15
HTM45-SN12.-D050-A22-Z05-H	50	5	22	42			
HTM45-SN12.-D063-A22-Z06-H	63	6	22	42			
HTM45-SN12.-D063-A22-Z07-H	63	7	22	42			
HTM45L-SN12.-D063-A22-Z07-H	63	7	22	42			
HTM45-SN12.-D080-A27-Z07-H	80	7	27	52			
HTM45-SN12.-D080-A27-Z08-H	80	8	27	52			
HTM45L-SN12.-D080-A27-Z08-H	80	8	27	52			
HTM45-SN12.-D100-A32-Z08-H	100	8	32	52			
HTM45-SN12.-D100-A32-Z10-H	100	10	32	52			
HTM45L-SN12.-D100-A32-Z10-H	100	10	32	52			
HTM45-SN12.-D125-B40-Z11	125	11	40	65			
HTM45L-SN12.-D125-B40-Z11	125	11	40	65			
HTM45-SN12.-D160-C40-Z12	160	12	40	65			
HTM45-SN12.-D200-C60-Z14	200	14	60	65			
HTM45L-SN12.-D200-C60-Z14	200	14	60	65			

ISO Compatible With



KAPR=45°





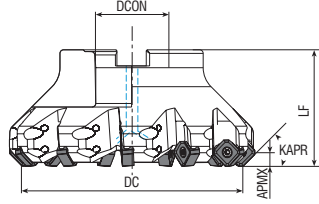

 Takım Kodu Ordering Code Bestell-Bezeichnung	Takım Ölçüleri (mm) Dimension (mm) Abmessung (mm)				Kesici Uç Insert Wendeschnei Platte	Sıkma Vidası Screw Schraube	Anahtar Allen Key Torx Schlüssel
	DC	Z	DCON	LF			
HTM45-SN13-D050-A22-Z05-H	50	5	22	40	SNMU 1305.	1080-M4x11	HTA-T15
HTM45-SN13-D063-A22-Z06-H	63	6	22	40			
HTM45-SN13-D080-A27-Z08-H	80	8	27	50			
HTM45-SN13-D100-A32-Z10-H	100	10	32	50			

ISO Compatible With



KAPR=45°





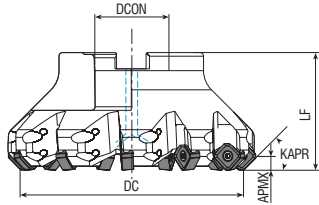

 Takım Kodu Ordering Code Bestell-Bezeichnung	Takım Ölçüleri (mm) Dimension (mm) Abmessung (mm)				Kesici Uç Insert Wendeschnei Platte	Sıkma Vidası Screw Schrauble	Anahtar Allen Key Torx Schlüssel
	DC	Z	DCON	LF			
HTM45-SN1306-D050-A22-Z05-H	50	5	22	40	SNGX 1306..	1070-M4x12	HTA-T15
HTM45-SN1306-D063-A22-Z06-H	63	6	22	40			
HTM45-SN1306-D080-A27-Z07-H	80	7	27	50			
HTM45-SN1306-D100-A32-Z08-H	100	8	32	50			

TOTC Compatible With



KAPR=45°





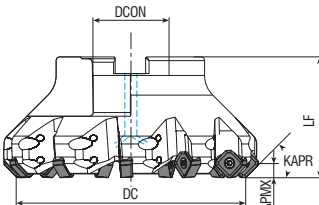

 Takım Kodu Ordering Code Bestell-Bezeichnung	Takım Ölçüleri (mm) Dimension (mm) Abmessung (mm)				Kesici Uç Insert Wendeschnei Platte	Sıkma Vidası Screw Schrauble	Anahtar Allen Key Torx Schlüssel
	DC	Z	DCON	LF			
HTM45-SN1205-D050-A22-Z05-H	50	5	22	42	SNEG 1205..	1060-M4x11	HTA-T15
HTM45-SN1205-D063-A22-Z06-H	63	6	22	42			
HTM45-SN1205-D080-A27-Z07-H	80	7	27	52			
HTM45-SN1205-D100-A32-Z09-H	100	9	32	52			
HTM45-SN1205-D125-B40-Z11	125	11	40	65			
HTM45-SN1205-D160-C40-Z12	160	12	60	65			
HTM45-SN1205-D200-C60-Z14	200	14	60	65			

ZCC Compatible With



KAPR=45°





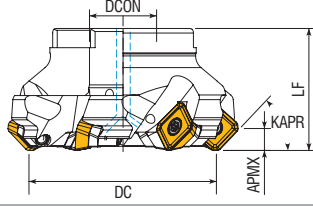

 Takım Kodu Ordering Code Bestell-Bezeichnung	Takım Ölçüleri (mm) Dimension (mm) Abmessung (mm)				Kesici Uç Insert Wendeschnei Platte	Sıkma Vidası Screw Schrauble	Anahtar Allen Key Torx Schlüssel
	DC	Z	DCON	LF			
HTM45-R345.13-D050-A22-Z05-H	50	5	22	42	R345.13..	1070-M4x12	HTA-T15
HTM45-R345.13-D063-A22-Z06-H	63	6	22	42			
HTM45-R345.13-D080-A27-Z07-H	80	7	27	52			
HTM45-R345.13-D100-A32-Z09-H	100	9	32	52			

SNDK Compatible With



KAPR=45°





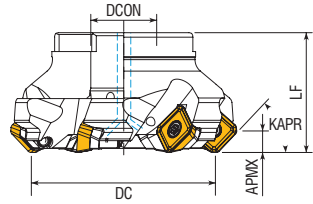

 Takım Kodu Ordering Code Bestell-Bezeichnung	Takım Ölçüleri (mm) Dimension (mm) Abmessung (mm)				Kesici Uç Insert Wendeschnei Platte	Sıkma Vidası Screw Schraube	Anahtar Allen Key Torx Schlüssel
	DC	Z	DCON	LF			
HTM45-SE12-D050-A22-Z04-H	50	4	22	40	"SE. 12T3. R245-12T3."	1060-M3.5x12	HTA-T15
HTM45L-SE12-D050-A22-Z04-H	50	4	22	40			
HTM45-SE12-D063-A22-Z05-H	63	5	22	40			
HTM45L-SE12-D063-A22-Z05-H	63	5	22	40			
HTM45-SE12-D080-A27-Z06-H	80	6	27	50			
HTM45L-SE12-D080-A27-Z06-H	80	6	27	50			
HTM45-SE12-D100-A32-Z07-H	100	7	32	50			
HTM45-SE12-D125-B40-Z08	125	8	40	63			
HTM45-SE12-D160-C40-Z10	160	10	40	63			
HTM45L-SE12-D160-C40-Z10	160	10	40	63			
HTM45-SE12-D200-C60-Z12	200	12	60	63			

ZCS&MVC Compatible With



KAPR=45°





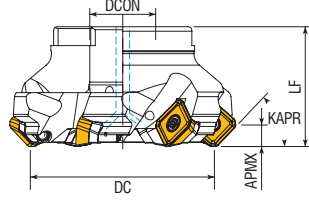

 Takım Kodu Ordering Code Bestell-Bezeichnung	Takım Ölçüleri (mm) Dimension (mm) Abmessung (mm)				Kesici Uç Insert Wendeschnei Platte	Sıkma Vidası Screw Schraube	Anahtar Allen Key Torx Schlüssel
	DC	Z	DCON	LF			
HTM45-SE13-D050-A22-Z04-H	50	4	22	40	SEMT 13T3.	1060-M3.5x12	HTA-T15
HTM45-SE13-D063-A22-Z05-H	63	5	22	40			
HTM45-SE13-D080-A27-Z06-H	80	6	27	50			

SM&M-DT Compatible With



KAPR=45°





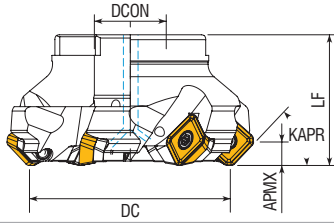

 Takım Kodu Ordering Code Bestell-Bezeichnung	Takım Ölçüleri (mm) Dimension (mm) Abmessung (mm)				Kesici Uç Insert Wendeschnel Platte	Sıkma Vidası Screw Schrauble	Anahtar Allen Key Torx Schlüssel
	DC	Z	DCON	LF			
HTM45-SE14M4-D063-A22-Z04-H	63	4	22	40	 SE.14M4.	 1060-M3.5x12	 HTA-T15
HTM45-SE14M4-D080-A27-Z05-H	80	5	27	50			
HTM45-SE14M4-D100-A32-Z07-H	100	7	32	50			
HTM45-SE14M4-D125-B40-Z08	125	8	40	63			
HTM45-SE14M4-D160-C40-Z10	160	10	40	63			

KRIV Compatible With



KAPR=45°





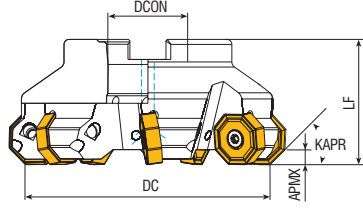

 Takım Kodu Ordering Code Bestell-Bezeichnung	Takım Ölçüleri (mm) Dimension (mm) Abmessung (mm)				Kesici Uç Insert Wendeschnel Platte	Sıkma Vidası Screw Schrauble	Anahtar Allen Key Torx Schlüssel
	DC	Z	DCON	LF			
HTM45-SE13T3-D050-A22-Z04-H	50	4	22	42	 SEMT 13T3.	 1060-M3.5x12	 HTA-T15
HTM45-SE13T3-D063-A22-Z05-H	63	5	22	42			
HTM45-SE13T3-D080-A27-Z06-H	80	6	27	52			
HTM45-SE13T3-D100-A32-Z07-H	100	7	32	52			
HTM45-SE13T3-D125-B40-Z08	125	8	40	65			

MTSBH Compatible With



KAPR=45°





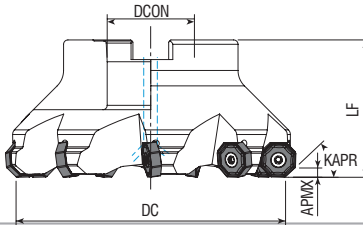

 Takım Kodu Ordering Code Bestell-Bezeichnung	Takım Ölçüleri (mm) Dimension (mm) Abmessung (mm)				Kesici Uç Insert Wendeschnei Platte	Sıkma Vidası Screw Schrauble	Anahtar Allen Key Torx Schlüssel
	DC	Z	DCON	LF			
HTM45-ON0806-D050-A22-Z04-H	50	5	22	40	ON..0806..	1060-M5x14	HTA-T20
HTM45-ON0806-D063-A22-Z05-H	63	5	22	40			
HTM45-ON0806-D063-A22-Z06-H	63	6	22	40			
HTM45-ON0806-D063-A22-Z07-H	63	7	22	40			
HTM45-ON0806-D080-A27-Z06-H	80	6	27	50			
HTM45-ON0806-D080-A27-Z08-H	80	8	27	50			
HTM45-ON0806-D100-A32-Z07-H	100	7	32	50			
HTM45-ON0806-D100-A32-Z10-H	100	10	32	50			
HTM45-ON0806-D125-B40-Z08	125	8	40	63			
HTM45-ON0806-D125-B40-Z12	125	12	40	63			
HTM45-ON0806-D160-C40-Z10	160	10	40	63			
HTM45-ON0806-D160-C40-Z14	160	14	40	63			
HTM45-ON0806-D200-C60-Z12	200	12	60	63			
HTM45-ON0806-D250-C60-Z14	250	14	60	63			
HTM45-ON0806-D315-D60-Z16	315	16	60	63			

ISO Compatible With



KAPR=43°





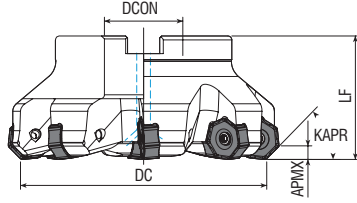

 Takım Kodu Ordering Code Bestell-Bezeichnung	Takım Ölçüleri (mm) Dimension (mm) Abmessung (mm)				Kesici Uç Insert Wendeschnei Platte	Sıkma Vidası Screw Schrauble	Anahtar Allen Key Torx Schlüssel
	DC	Z	DCON	LF			
HTM43-ON0604-D050-A22-Z05-H	50	5	22	40	ON..0604..	1060-M4x11	HTA-T15
HTM43-ON0604-D063-A22-Z06-H	63	6	22	40			
HTM43-ON0604-D080-A27-Z07-H	80	7	27	50			
HTM43-ON0604-D100-A32-Z08-H	100	8	32	50			
HTM43-ON0604-D125-B40-Z09	125	9	40	63			

ZCC Compatible With



KAPR=44°





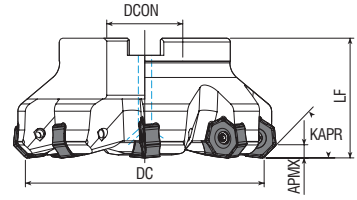

 Takım Kodu Ordering Code Bestell-Bezeichnung	Takım Ölçüleri (mm) Dimension (mm) Abmessung (mm)				Kesici Uç Insert Wendeschnei Platte	Sıkma Vidası Screw Schrauble	Anahtar Allen Key Torx Schlüssel
	DC	Z	DCON	LF			
HTM44-ON0606-D063-A22-Z06-H	63	6	22	40			
HTM44-ON0606-D080-A27-Z08-H	80	8	27	50	ONHX 0606.	1060-M4.5x12	HTA-T20
HTM44-ON0606-D100-A32-Z10-H	100	10	32	50			

KTR Compatible With



KAPR=45°





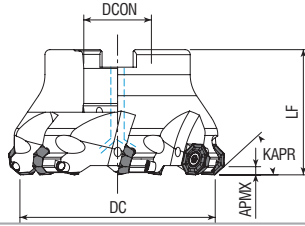

 Takım Kodu Ordering Code Bestell-Bezeichnung	Takım Ölçüleri (mm) Dimension (mm) Abmessung (mm)				Kesici Uç Insert Wendeschnei Platte	Sıkma Vidası Screw Schrauble	Anahtar Allen Key Torx Schlüssel
	DC	Z	DCON	LF			
HTM45-ON0505-D050-A22-Z05-H	50	5	22	40			
HTM45-ON0505-D063-A22-Z06-H	63	6	22	40	ONHU 0505.	1060-M5x12	HTA-T20
HTM45-ON0505-D080-A27-Z07-H	80	7	27	50			
HTM45-ON0505-D100-A32-Z08-H	100	8	32	50			

ISCR Compatible With



KAPR=43°





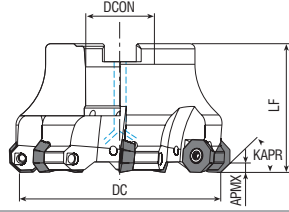

 Takım Kodu Ordering Code Bestell-Bezeichnung	Takım Ölçüleri (mm) Dimension (mm) Abmessung (mm)				Kesici Uç Insert Wendeschnei Platte	Sıkma Vidası Screw Schrauble	Anahtar Allen Key Torx Schlüssel
	DC	Z	DCON	LF			
HTM43-OF05T3-D050-A22-Z05-H	50	5	22	40			
HTM43-OF05T3-D063-A22-Z06-H	63	6	22	40	OF..05T3.	1060-M4x11	HTA-T15
HTM43-OF05T3-D080-A27-Z07-H	80	7	27	50			
HTM43-OF05T3-D125-B40-Z09	125	9	40	63			

ISO Compatible With



KAPR=43°





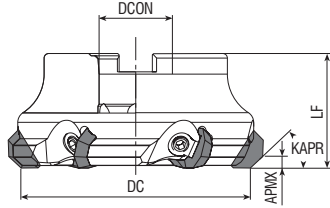

 Takım Kodu Ordering Code Bestell-Bezeichnung	Takım Ölçüleri (mm) Dimension (mm) Abmessung (mm)				Kesici Uç Insert Wendeschnei Platte	Sıkma Vidası Screw Schrauble	Anahtar Allen Key Torx Schlüssel
	DC	Z	DCON	LF			
HTM43-OD0504-D040-A16-Z04-H	40	4	16	40	OD. 0504..	1060-M3.5x12	HTA-T15
HTM43-OD0504-D050-A22-Z05-H	50	5	22	40			
HTM43-OD0504-D063-A22-Z06-H	63	6	22	40			
HTM43-OD0504-D080-A27-Z07-H	80	7	27	50			
HTM43-OD0504-D100-A32-Z08-H	100	8	32	50			
HTM43-OD0605-D063-A22-Z05-H	63	5	22	40	OD. 0605..	1060-M5x12	HTA-T20
HTM43-OD0605-D080-A27-Z06-H	80	6	27	50			
HTM43-OD0605-D100-A32-Z07-H	100	8	32	100			
HTM43-OD0605-D125-B40-Z08	125	8	40	125			

MTR Compatible With







KAPR=43°

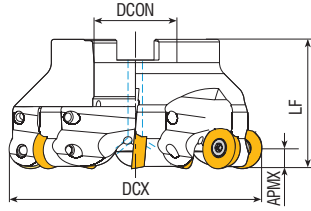

 Takım Kodu Ordering Code Bestell-Bezeichnung	Takım Ölçüleri (mm) Dimension (mm) Abmessung (mm)				Kesici Uç Insert Wendeschnei Platte	Sıkma Vidası Screw Schrauble	Baskı Pabucu Wedge Clamp Spannpratze	Anahtar Allen Key Torx Schlüssel
	DC	Z	DCON	LF				
HTM43C-OF07-D063-A22-Z04	63	4	22	45	OF. 0704..	HPV-20-M8x1x18	HBP-20	HAL-04
HTM43C-OF07-D080-A27-Z05	80	5	27	50				
HTM43C-OF07-D100-A32-Z06	100	6	32	50				
HTM43C-OF07-D125-B40-Z08	125	8	40	63				
HTM43C-OF07-D160-C40-Z09	160	9	40	63				

ISO Compatible With





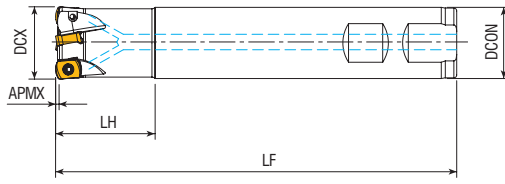

 Takım Kodu Ordering Code Bestell-Bezeichnung	Takım Ölçüleri (mm) Dimension (mm) Abmessung (mm)				Kesici Uç Insert Wendeschnei Platte	Sıkma Vidası Screw Schrauble	Anahtar Allen Key Torx Schlüssel
	DC	Z	DCON	LF			
HTM-RD0702-D050-A22-Z06-H	50	6	22	40	RD. 0702.	1060-M2.5x6	HTA-T08
HTM-RD0803-D050-A22-Z05-H	50	5	22	40	RD. 0803.	1060-M3x8	
HTM-RD1003-D040-A16-Z04-H	40	4	16	40	RD. 1003.	1060-M3.5x9	HTA-T15
HTM-RD1003-D050-A22-Z05-H	50	5	22	50			
HTM-RD1003-D052-A22-Z05	52	5	22	50			
HTM-RD1003-D063-A22-Z06-H	63	6	22	50			
HTM-RD1003-D080-A27-Z07-H	80	7	27	50			
HTM-RD1003-D100-A32-Z08-H	100	8	32	50			
HTM-RD10T3-D040-A16-Z04-H	40	4	16	40			
HTM-RD10T3-D050-A22-Z05-H	50	5	22	50	RD. 12T3.	1060-M3.5x9	HTA-T15
HTM-RD10T3-D063-A22-Z06-H	63	6	22	50			
HTM-RD12T3-D040-A16-Z04-H	40	4	16	40			
HTM-RD12T3-D050-A22-Z05-H	50	5	22	50			
HTM-RD12T3-D052-A22-Z05-H	52	5	22	50			
HTM-RD12T3-D063-A22-Z06-H	63	6	22	50			
HTM-RD12T3-D080-A27-Z07-H	80	7	27	50			
HTM-RD12T3-D100-A32-Z08-H	100	8	32	50	RD. 1204.	1060-M4.5x12	HTA-T20
HTM-RD12T3-D125-B40-Z09	125	9	40	63			
HTM-RD1204-D040-A16-Z04-H	40	4	16	40			
HTM-RD1204-D050-A22-Z05-H	50	5	22	50			
HTM-RD1204-D052-A22-Z05-H	52	5	22	50			
HTM-RD1204-D063-A22-Z06-H	63	6	22	50			
HTM-RD1204-D080-A27-Z07-H	80	7	27	50			
HTM-RD1204-D100-A32-Z07-H	100	7	32	50			
HTM-RD1204-D100-A32-Z08-H	100	8	32	50	RD. 1604.	1060-M4.5x12	HTA-T20
HTM-RD1604-D050-A22-Z04-H	50	4	22	50			
HTM-RD1604-D052-A22-Z04-H	52	4	22	50			
HTM-RD1604-D063-A22-Z05-H	63	5	22	50			
HTM-RD1604-D066-A22-Z05-H	66	5	22	50			
HTM-RD1604-D066-A27-Z05-H	66	5	27	50			
HTM-RD1604-D080-A27-Z06-H	80	6	27	50			
HTM-RD1604-D100-A32-Z07-H	100	7	32	50			
HTM-RD1604-D125-B40-Z07	125	7	40	63			
HTM-RD1604-D160-C40-Z08	160	8	40	63			

WTR Compatible With







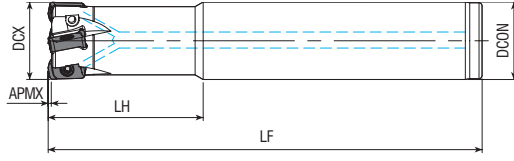

 Takım Kodu Ordering Code Bestell-Bezeichnung	Takım Ölçüleri (mm) Dimension (mm) Abmessung (mm)					Kesici Uç Insert Wendescheibe	Sıkma Vidası Screw Schraube	Anahtar Allen Key Torx Schlüssel
	DC	Z	DCON	LF	LH			
HFM-BL0603-D16-C16-L100-Z02-H	16	2	16	100	30	BLMP 0603.	1060-M2.5x6	HTA-T08
HFM-BL0603-D16-W16-L150-Z02-H	16	2	16	150	50			
HFM-BL0603-D17-W16-L150-Z02-H	17	2	16	150	20			
HFM-BL0603-D17-C16-L200-Z02	17	2	16	200	30			
HFM-BL0603-D18-W16-L150-Z02-H	18	2	16	150	20			
HFM-BL0603-D20-W20-L150-Z03-H	20	3	20	150	50			
HFM-BL0603-D20-C20-L200-Z03	20	3	20	200	50			
HFM-BL0603-D21-W20-L150-Z03-H	21	3	20	150	25			
HFM-BL0603-D21-C20-L200-Z03	21	3	20	200	25			
HFM-BL0603-D22-W20-L150-Z03-H	22	3	20	150	20			
HFM-BL0603-D25-W25-L150-Z04-H	25	4	25	150	40			
HFM-BL0603-D25-C25-L200-Z04	25	4	25	200	40			
HFM-BL0603-D26-W25-L150-Z04-H	26	4	25	150	35			
HFM-BL0603-D26-C25-L200-Z04	26	4	25	200	35			
HFM-BL0603-D26-C25-L250-Z04	26	4	25	250	35			
HFM-BL0603-D32-W32-L150-Z05-H	32	5	32	150	50			
HFM-BL0603-D32-C32-L200-Z05	32	5	32	200	70			
HFM-BL0603-D33-W32-L150-Z05-H	33	5	32	150	40			
HFM-BL0603-D33-C32-L200-Z05	33	5	32	200	40			
HFM-BL0603-D35-W32-L150-Z05-H	35	5	32	250	40			
HFM-BL0904-D25-W25-L150-Z03-H	25	3	25	150	40	BLMP 0904.	1070-M3.5x8	HTA-T10
HFM-BL0904-D26-W25-L150-Z03-H	26	3	25	150	35			
HFM-BL0904-D28-W25-L150-Z03-H	28	3	25	150	30			
HFM-BL0904-D32-W32-L150-Z04-H	32	4	32	150	40			
HFM-BL0904-D33-W32-L150-Z04-H	33	4	32	150	40			

TGT Compatible With







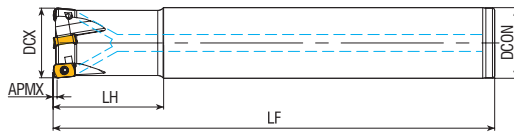

 Takım Kodu Ordering Code Bestell-Bezeichnung	Takım Ölçüleri (mm) Dimension (mm) Abmessung (mm)					Kesici Uç Insert Wendeschneidplatte	Sıkma Vidası Screw Schrauble	Anahtar Allen Key Torx Schlüssel
	DC	Z	DCON	LF	LH			
HFM-LO03-D16-C16-L100-Z02-H	16	2	16	100	30	LOGU 0303.	1070-M3x6.8	HTA-T08
HFM-LO03-D16-W16-L150-Z02-H	16	2	16	150	40			
HFM-LO03-D17-W16-L150-Z02-H	17	2	16	150	30			
HFM-LO03-D17-C16-L200-Z02	17	2	16	200	30			
HFM-LO03-D20-C20-L100-Z03-H	20	3	20	100	40			
HFM-LO03-D20-W20-L150-Z03-H	20	3	20	150	40			
HFM-LO03-D21-W20-L150-Z03-H	21	3	20	150	30			
HFM-LO03-D21-C20-L200-Z03	21	3	20	200	30			
HFM-LO03-D22-W20-L150-Z03-H	22	3	20	150	30			
HFM-LO03-D25-W25-L100-Z04-H	25	4	25	100	50			
HFM-LO03-D25-W25-L150-Z04-H	25	4	25	150	50			
HFM-LO03-D25-C25-L200-Z04	25	4	25	200	70			
HFM-LO03-D26-W25-L150-Z04-H	26	4	25	150	40			
HFM-LO03-D26-C20-L200-Z04-H	26	4	25	200	40			
HFM-LO03-D32-W32-L150-Z05-H	32	5	32	150	40			
HFM-LO03-D32-C32-L200-Z05	32	5	32	200	70			
HFM-LO03-D33-C32-L150-Z05-H	33	5	32	250	40			

KYCR Compatible With



 Takım Kodu Ordering Code Bestell-Bezeichnung	Takım Ölçüleri (mm) Dimension (mm) Abmessung (mm)					Kesici Uç Insert Wendeschneidplatte	Sıkma Vidası Screw Schrauble	Anahtar Allen Key Torx Schlüssel
	DC	Z	DCON	LF	LH			
HFM-EN1004-D16-W16-L150-Z02-H	16	2	16	150	25	ENMU 1004.	1060-M2.5x6	HTA-T08
HFM-EN1004-D17-C16-L150-Z02-H	17	2	16	150	25			
HFM-EN1004-D18-W16-L150-Z02-H	18	2	16	150	25			
HFM-EN1004-D20-W20-L150-Z03-H	20	3	20	150	40			
HFM-EN1004-D21-W20-L150-Z03-H	21	3	20	150	30			
HFM-EN1004-D22-W20-L150-Z03-H	22	3	20	150	30			
HFM-EN1004-D25-W25-L150-Z04-H	25	4	25	150	40			
HFM-EN1004-D26-W25-L150-Z04-H	26	4	25	150	30			
HFM-EN1004-D28-W25-L150-Z04-H	28	4	25	150	30			
HFM-EN1004-D32-W32-L150-Z04-H	32	4	32	150	50			
HFM-EN1004-D33-W32-L150-Z04-H	33	4	32	150	30			



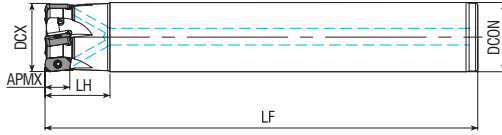

DTT Compatible With

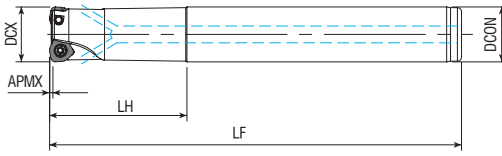

 Takım Kodu Ordering Code Bestell-Bezeichnung	Takım Ölçüleri (mm) Dimension (mm) Abmessung (mm)					Kesici Uç Insert Wendeschnelplatte	Sıkma Vidası Screw Schrauble	Anahtar Allen Key Torx Schlüssel
	DC	Z	DCON	LF	LH			
HFM-LN0303-D16-W16-L150-Z02-H	16	2	16	150	50	LNMU 0303.	1060-M2.5x6	HTA-T08
HFM-LN0303-D17-W16-L150-Z02-H	17	2	16	150	50			
HFM-LN0303-D17-C17-L200-Z02	17	2	16	200	30			
HFM-LN0303-D18-W16-L150-Z02-H	18	2	16	150	50			
HFM-LN0303-D20-W20-L150-Z03-H	20	3	20	150	50			
HFM-LN0303-D21-W20-L150-Z03-H	21	3	20	150	30			
HFM-LN0303-D21-C20-L200-Z03	21	3	20	200	30			
HFM-LN0303-D22-W20-L150-Z03-H	22	3	20	150	30			
HFM-LN0303-D25-W25-L150-Z04-H	25	4	25	150	50			
HFM-LN0303-D26-W25-L150-Z04-H	26	4	25	150	30			
HFM-LN0303-D26-C25-L200-Z04	26	4	25	200	30			
HFM-LN0303-D28-W25-L150-Z04-H	28	4	25	150	30			
HFM-LN0303-D32-W32-L150-Z05-H	32	5	32	150	30			
HFM-LN0303-D33-W32-L150-Z05-H	33	5	32	150	30			
HFM-LN0303-D33-C32-L200-Z05	33	5	32	200	30			

TMGT Compatible With



 Takım Kodu Ordering Code Bestell-Bezeichnung	Takım Ölçüleri (mm) Dimension (mm) Abmessung (mm)					Kesici Uç Insert Wendeschnelplatte	Sıkma Vidası Screw Schrauble	Anahtar Allen Key Torx Schlüssel
	DC	Z	DCON	LF	LH			
HFM-WD06-D16-W16-L150-Z02-H	16	2	16	150	40	WDMT 0603.	1060-M2.5x6	HTA-T08
HFM-WD06-D18-W16-L150-Z02-H	16	2	16	150	40			
HFM-WD06-D20-W20-L150-Z03-H	20	3	20	150	40			
HFM-WD08-D20-W20-L150-Z02-H	20	2	20	150	40	WDMT 0804.	1060-M3x8	HTA-T08
HFM-WD08-D22-W20-L150-Z02-H	22	2	20	150	40			
HFM-WD08-D25-W25-L150-Z02-H	25	2	25	150	40			
HFM-WD08-D32-W32-L150-Z03-H	32	3	32	150	40			
HFM-WD08-D33-W32-L150-Z03-H	33	3	32	150	40			

SMTM Compatible With

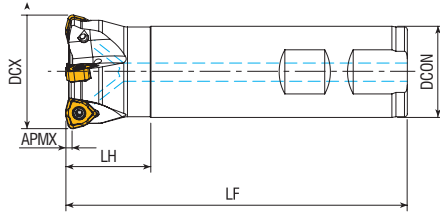

 Takım Kodu Ordering Code Bestell-Bezeichnung	Takım Ölçüleri (mm) Dimension (mm) Abmessung (mm)					Kesici Uç Insert Wendeschneidplatte	Sıkma Vidası Screw Schraube	Anahtar Allen Key Torx Schlüssel
	DC	Z	DCON	LF	LH			
HFM-WN0603-D16-C16-L100-Z02-H	16	2	16	100	30	WNMX 0603.	1060-M2.5x6	HTA-T08
HFM-WN0603-D16-W16-L150-Z02-H	16	2	16	150	70			
HFM-WN0603-D17-W16-L150-Z02-H	17	2	16	150	20			
HFM-WN0603-D20-W20-L150-Z02-H	20	2	20	150	70			
HFM-WN0603-D21-W20-L150-Z02-H	21	2	20	150	20			
HFM-WN0603-D25-W25-L150-Z03-H	25	3	25	150	40			
HFM-WN09T3-D25-W25-L150-Z02-H	25	2	25	150	40	WNMX 09T3.	1060-M3x8	HTA-T10
HFM-WN09T3-D25-C25-L200-Z02	25	2	25	200	70			
HFM-WN09T3-D26-W25-L150-Z02-H	26	2	25	150	40			
HFM-WN09T3-D32-W32-L150-Z03-H	32	3	32	150	30			
HFM-WN09T3-D32-C32-L200-Z03	32	3	32	200	70			
HFM-WN09T3-D33-W32-L150-Z03-H	33	3	32	150	30			
HFM-WN09T3-D33-C32-L200-Z03	33	3	32	200	70			
HFM-WN09T3-D35-W32-L150-Z04-H	35	4	32	150	30			
HFM-WN09T3-D35-W32-L200-Z04-H	35	4	32	200	50			
HFM-WN09T3-D40-W32-L150-Z04-H	40	4	32	150	30			
HFM-WN09T3-D40-C32-L200-Z04	40	4	32	200	30			

KRT Compatible With

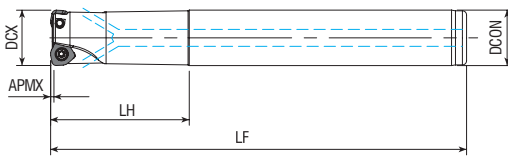

 Takım Kodu Ordering Code Bestell-Bezeichnung	Takım Ölçüleri (mm) Dimension (mm) Abmessung (mm)					Kesici Uç Insert Wendeschneidplatte	Sıkma Vidası Screw Schraube	Anahtar Allen Key Torx Schlüssel
	DC	Z	DCON	LF	LH			
HFM-WO04T2-D16-W16-L150-Z02-H	16	2	16	150	20	WOMW 04T2.	1060-M2.5x6	HTA-T08
HFM-WO04T2-D17-W16-L150-Z02-H	17	2	16	150	20			
HFM-WO04T2-D20-W20-L150-Z03-H	20	3	20	150	20			
HFM-WD0503-D20-W20-L150-Z02-H	20	2	20	150	50	WDW 0503.	1060-M3x6	HTA-T08
HFM-WD0503-D22-W20-L150-Z02-H	22	2	20	150	30			
HFM-WD06T3-D25-W25-L150-Z02-H	25	2	25	150	30	WDW 06T3.	1070-M3.5x8	HTA-T10
HFM-WD06T3-D32-W32-L150-Z03-H	32	3	32	150	32			

D1T Compatible With

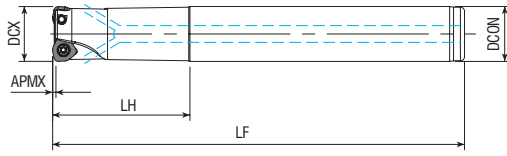

 Takım Kodu Ordering Code Bestell-Bezeichnung	Takım Ölçüleri (mm) Dimension (mm) Abmessung (mm)					Kesici Uç Insert Wendeschnelplatte	Sıkma Vidası Screw Schraube	Anahtar Allen Key Torx Schlüssel
	DC	Z	DCON	LF	LH			
HFM-JO06-D16-W16-L120-Z02-H	16	2	16	120	35	JOMT 06T2..	1060-M2.5x7	HTA-T08
HFM-JO06-D17-W16-L120-Z02-H	17	2	16	120	35			
HFM-JO06-D20-W20-L120-Z03-H	20	3	20	120	35			
HFM-JO06-D22-W20-L120-Z03-H	22	3	20	120	35	JOMT 0803..	1060-M3x8	HTA-T08
HFM-JO08-D22-W20-L150-Z02-H	22	2	20	150	35			
HFM-JO08-D26-W25-L150-Z03-H	26	3	25	150	35			
HFM-JD09-D25-W25-L150-Z02-H	25	2	25	150	35	JDM.09T3..	1070-M3.5x9	HTA-T15
HFM-JD09-D26-W25-L150-Z02-H	26	2	25	150	35			
HFM-JD09-D32-W32-L150-Z03-H	32	3	32	150	35			
HFM-JD09-D33-W32-L150-Z03-H	33	3	32	150	35			

MTSBH Compatible With

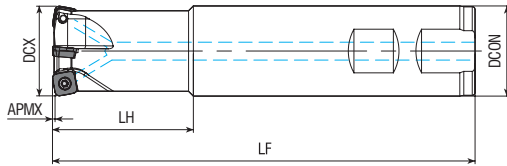



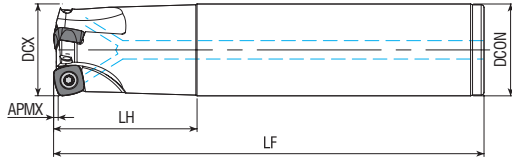

 Takım Kodu Ordering Code Bestell-Bezeichnung	Takım Ölçüleri (mm) Dimension (mm) Abmessung (mm)					Kesici Uç Insert Wendeschnelplatte	Sıkma Vidası Screw Schraube	Anahtar Allen Key Torx Schlüssel
	DC	Z	DCON	LF	LH			
HFM-SD06T2-D16-C16-L100-Z02-H	16	2	16	100	50	SD..06T2..	1060-M2.2x5	HTA-T06
HFM-SD06T2-D16-W16-L150-Z02-H	16	2	16	150	50			
HFM-SD06T2-D17-W16-L150-Z02-H	17	2	16	150	50			
HFM-SD06T2-D20-W20-L150-Z03-H	20	3	20	150	50			
HFM-SD06T2-D21-W20-L150-Z03-H	21	3	20	150	50			
HFM-SD06T2-D25-W25-L150-Z04-H	25	4	25	150	60			
HFM-SD06T2-D26-W25-L150-Z04-H	26	4	25	150	60	SD..09T3..	1060-M3.5x9	HTA-T15
HFM-SD09T3-D22-W20-L150-Z02-H	22	2	20	150	30			
HFM-SD09T3-D25-W25-L150-Z02-H	25	2	25	150	94			
HFM-SD09T3-D28-W25-L150-Z02-H	28	2	25	150	30			
HFM-SD09T3-D32-W32-L150-Z03-H	32	3	32	150	90			

ZCC Compatible With







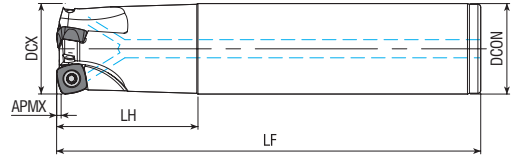

 Takım Kodu Ordering Code Bestell-Bezeichnung	Takım Ölçüleri (mm) Dimension (mm) Abmessung (mm)					Kesici Uç Insert Wendeschnelplatte	Sıkma Vidası Screw Schraube	Anahtar Allen Key Torx Schlüssel
	DC	Z	DCON	LF	LH			
HFM-SP1004-D25-W25-L150-Z02-H	25	2	25	150	50			
HFM-SP1004-D32-W32-L150-Z03-H	32	3	32	150	50	SPNW 1004..	1060-M3.5x9	HTA-T15





DTR Compatible With

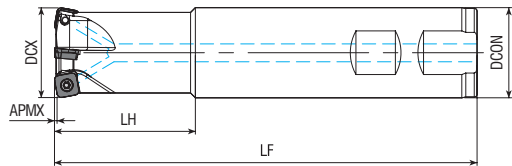

 Takım Kodu Ordering Code Bestell-Bezeichnung	Takım Ölçüleri (mm) Dimension (mm) Abmessung (mm)					Kesici Uç Insert Wendeschnelplatte	Sıkma Vidası Screw Schraube	Anahtar Allen Key Torx Schlüssel
	DC	Z	DCON	LF	LH			
HFM-SO1004-D32-W32-L150-Z03-H	32	3	32	150	40			
HFM-SO1004-D35-W32-L150-Z03-H	35	3	32	150	40	SOMT 1004..	1060-M4x9	HTA-T15
HFM-SO1004-D40-W32-L150-Z04-H	40	4	32	150	40			





KTR Compatible With

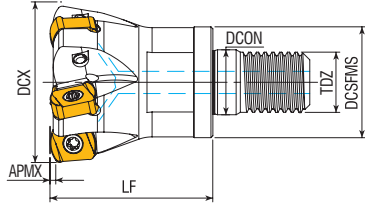

 Takım Kodu Ordering Code Bestell-Bezeichnung	Takım Ölçüleri (mm) Dimension (mm) Abmessung (mm)					Kesici Uç Insert Wendeschnelplatte	Sıkma Vidası Screw Schraube	Anahtar Allen Key Torx Schlüssel
	DC	Z	DCON	LF	LH			
HFM-R210.09-D25-W25-L150-Z02-H	25	2	25	150	35			
HFM-R210.09-D26-W25-L150-Z02-H	26	2	25	150	35	R210.09..	1060-M3.5x9	HTA-T15
HFM-R210.09-D32-W32-L150-Z03-H	32	3	32	150	35			
HFM-R210.09-D33-W32-L150-Z03-H	33	3	32	150	35			





SNDVX Compatible With

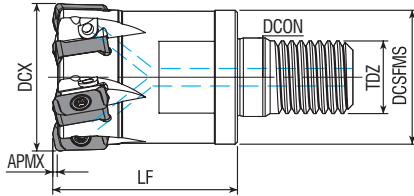

 Takım Kodu Ordering Code Bestell-Bezeichnung	Takım Ölçüleri (mm) Dimension (mm) Abmessung (mm)						Kesici Uç Insert Wendeschnelplatte	Sıkma Vidası Screw Schraube	Anahtar Allen Key Torx Schlüssel
	DC	Z	DCSFMS	TDZ	LF	DCON			
HFM-BL0603-D16-M08-L25-Z02-H	16	2	15	M08	25	8.5	BLMP 0603..	1060-M2.5x6	HTA-T08
HFM-BL0603-D20-M10-L30-Z03-H	20	3	18	M10	30	10.5			
HFM-BL0603-D25-M12-L35-Z04-H	25	4	21	M12	35	12.5			
HFM-BL0603-D32-M16-L43-Z05-H	32	5	29	M16	43	17			
HFM-BL0603-D35-M16-L43-Z05-H	35	5	29	M16	43	17			
HFM-BL0603-D40-M16-L43-Z06-H	40	6	29	M16	43	17			
HFM-BL0603-D42-M16-L43-Z06-H	40	6	29	M16	43	17	BLMP 0904..	1070-M3.5x8	HTA-T10
HFM-BL0904-D25-M12-L35-Z03-H	25	3	21	M12	35	12.5			
HFM-BL0904-D32-M16-L43-Z04-H	32	4	29	M16	43	17			
HFM-BL0904-D35-M16-L43-Z04-H	35	4	29	M16	43	17			
HFM-BL0904-D42-M16-L43-Z05-H	42	5	29	M16	43	17			







TCTC Compatible With

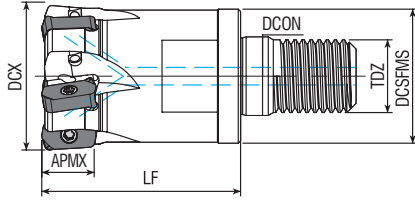

 Takım Kodu Ordering Code Bestell-Bezeichnung	Takım Ölçüleri (mm) Dimension (mm) Abmessung (mm)						Kesici Uç Insert Wendeschnelplatte	Sıkma Vidası Screw Schraube	Anahtar Allen Key Torx Schlüssel
	DC	Z	DCSFMS	TDZ	LF	DCON			
HFM-LO03-D16-M08-L25-Z02-H	16	2	15	M08	25	8.5	LOGU 0303..	1070-M3x6.8	HTA-T08
HFM-LO03-D20-M10-L30-Z03-H	20	3	18	M10	30	10.5			
HFM-LO03-D20-M10-L30-Z04-H	20	4	18	M10	30	10.5			
HFM-LO03-D25-M12-L35-Z04-H	25	4	21	M12	35	12.5			
HFM-LO03-D32-M16-L43-Z05-H	32	5	29	M16	40	17			
HFM-LO03-D32-M16-L43-Z06-H	32	6	29	M16	40	17			
HFM-LO03-D35-M16-L43-Z05-H	35	5	29	M16	40	17			
HFM-LO03-D35-M16-L43-Z06-H	35	6	29	M16	40	17			
HFM-LO03-D42-M16-L43-Z05-H	42	5	29	M16	40	17			
HFM-LO03-D42-M16-L43-Z06-H	42	6	29	M16	40	17			







KVCR Compatible With

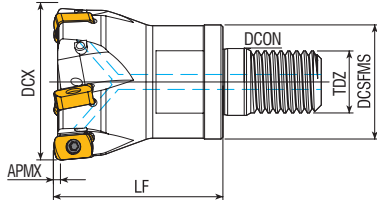

 Takım Kodu Ordering Code Bestell-Bezeichnung	Takım Ölçüleri (mm) Dimension (mm) Abmessung (mm)						Kesici Uç Insert Wendeschnelplatte	Sıkma Vidası Screw Schraube	Anahtar Allen Key Torx Schlüssel
	DC	Z	DCSFMS	TDZ	LF	DCON			
HFM-LN0303-D16-M08-L25-Z02-H	16	2	15	M08	25	8.5	LNMU 0303..		
HFM-LN0303-D20-M10-L30-Z03-H	20	3	18	M10	30	10.5			
HFM-LN0303-D25-M12-L35-Z04-H	25	4	21	M12	35	12.5			
HFM-LN0303-D32-M16-L43-Z05-H	32	5	29	M16	43	17			
HFM-LN0303-D40-M16-L43-Z06-H	40	6	29	M16	43	17			
HFM-LN0303-D42-M16-L43-Z06-H	42	6	29	M16	43	17			







TNG/L Compatible With

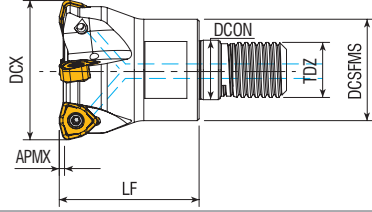

 Takım Kodu Ordering Code Bestell-Bezeichnung	Takım Ölçüleri (mm) Dimension (mm) Abmessung (mm)						Kesici Uç Insert Wendeschnelplatte	Sıkma Vidası Screw Schraube	Anahtar Allen Key Torx Schlüssel
	DC	Z	DCSFMS	TDZ	LF	DCON			
HFM-EN1004-D16-M08-L25-Z02-H	16	2	15	M08	25	8.5	ENMU 1004..		
HFM-EN1004-D20-M10-L30-Z03-H	20	3	18	M10	30	10.5			
HFM-EN1004-D25-M12-L35-Z04-H	25	4	21	M12	35	12.5			
HFM-EN1004-D32-M16-L43-Z05-H	32	5	29	M16	43	17			
HFM-EN1004-D35-M16-L43-Z05-H	35	5	29	M16	43	17			
HFM-EN1004-D40-M16-L43-Z05-H	40	5	29	M16	43	17			
HFM-EN1004-D42-M16-L43-Z05-H	42	5	29	M16	43	17			





DT Compatible With

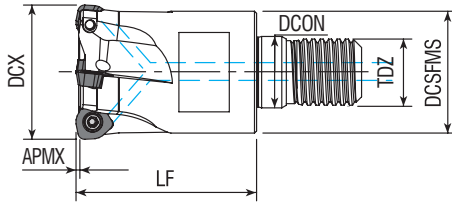

 Takım Kodu Ordering Code Bestell-Bezeichnung	Takım Ölçüleri (mm) Dimension (mm) Abmessung (mm)						Kesici Uç Insert Wendschnei Platte	Sıkma Vidası Screw Schraube	Anahtar Allen Key Torx Schlüssel
	DC	Z	DCSFMS	TDZ	LF	DCON			
HFM-WN0603-D20-M10-L30-Z02-H	20	2	18	M10	30	10.5	 WNMX 0603..	 1060-M2.5x6	 HTA-T08
HFM-WN0603-D25-M12-L35-Z03-H	25	3	21	M12	35	12.5			
HFM-WN0603-D32-M16-L43-Z04-H	32	4	29	M16	43	17			
HFM-WN09T3-D25-M12-L35-Z02-H	25	2	21	M12	35	12.5	 WNMX 09T3..	 1060-M3x8	 HTA-T10
HFM-WN09T3-D32-M16-L43-Z03-H	32	3	29	M16	43	17			
HFM-WN09T3-D35-M16-L43-Z04-H	35	4	29	M16	43	17			
HFM-WN09T3-D40-M16-L43-Z04-H	40	4	29	M16	43	17			
HFM-WN09T3-D42-M16-L43-Z04-H	42	4	29	M16	43	17			





KRV Compatible With

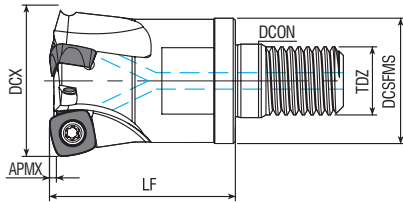

 Takım Kodu Ordering Code Bestell-Bezeichnung	Takım Ölçüleri (mm) Dimension (mm) Abmessung (mm)						Kesici Uç Insert Wendschnei Platte	Sıkma Vidası Screw Schraube	Anahtar Allen Key Torx Schlüssel
	DC	Z	DCSFMS	TDZ	LF	DCON			
HFM-WD08-D25-M12-L35-Z02-H	25	2	21	M12	35	12.5	 WDMT 0804..	 1060-M3x8	 HTA-T08
HFM-WD08-D32-M16-L43-Z03-H	32	3	29	M16	43	17			
HFM-WD08-D35-M16-L43-Z04-H	35	4	29	M16	43	17			







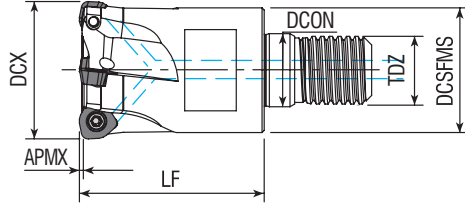

SNM Compatible With



 Takım Kodu Ordering Code Bestell-Bezeichnung	Takım Ölçüleri (mm) Dimension (mm) Abmessung (mm)						Kesici Uç Insert Wendschnei Platte	Sıkma Vidası Screw Schraube	Anahtar Allen Key Torx Schlüssel
	DC	Z	DCSFMS	TDZ	LF	DCON			
HFM-SP1004-D25-M12-L35-Z02-H	25	2	21	M12	35	12.5	 SPNW1004..	 1060-M3.5x9	 HTA-T15
HFM-SP1004-D32-M16-L43-Z03-H	32	3	29	M16	43	17			
HFM-SP1004-D35-M16-L43-Z03-H	35	3	29	M16	43	17			
HFM-SP1004-D42-M16-L43-Z04-H	42	4	29	M16	43	17			









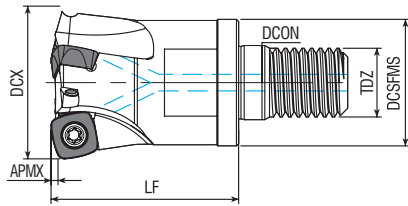

DT Compatible With



 Takım Kodu Ordering Code Bestell-Bezeichnung	Takım Ölçüleri (mm) Dimension (mm) Abmessung (mm)						Kesici Uç Insert Wändeschnei Platte	Sıkma Vidası Screw Schraube	Anahtar Allen Key Torx Schlüssel
	DC	Z	DCSFMS	TDZ	LF	DCON			
HFM-JO08-D25-M12-L35-Z03-H	25	3	21	M12	35	12.5	 JOMT 0803.	 1060-M3x8	 HTA-T08
HFM-JO08-D32-M16-L43-Z04-H	32	4	29	M16	43	17			
HFM-JO08-D35-M16-L43-Z04-H	35	4	29	M16	43	17			
HFM-JD09-D25-M12-L35-Z02-H	25	2	21	M12	35	12.5	 JDM.09T3.	 1060-M3.5x9	 HTA-T15
HFM-JD09-D32-M16-L43-Z03-H	32	3	29	M16	43	17			
HFM-JD09-D35-M16-L43-Z03-H	35	3	29	M16	43	17			
HFM-JD1204-D32-M16-L43-Z02-H	32	2	29	M16	43	17	 JDMW 1204.	 1060-M4x11	
HFM-JD1204-D42-M16-L43-Z03-H	42	3	29	M16	43	17			





MTSBH Compatible With

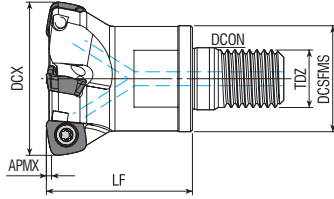

 Takım Kodu Ordering Code Bestell-Bezeichnung	Takım Ölçüleri (mm) Dimension (mm) Abmessung (mm)						Kesici Uç Insert Wändeschnei Platte	Sıkma Vidası Screw Schraube	Anahtar Allen Key Torx Schlüssel
	DC	Z	DCSFMS	TDZ	LF	DCON			
HFM-SD06T2-D16-M08-L25-Z02-H	16	2	15	M08	25	8.5	 SD.06T2.	 1060-M2.2x5	 HTA-T06
HFM-SD06T2-D20-M10-L30-Z03-H	20	3	18	M10	30	10.5			
HFM-SD06T2-D25-M12-L35-Z04-H	25	4	21	M12	35	12.5			
HFM-SD09T3-D25-M12-L35-Z02-H	25	2	22	M12	35	12.5	 SD.09T3.	 1060-M3.5x9	 HTA-T15
HFM-SD09T3-D32-M16-L43-Z03-H	32	3	29	M16	43	17			
HFM-SD09T3-D35-M16-L43-Z03-H	35	3	29	M16	43	17			
HFM-SD09T3-D40-M16-L43-Z04-H	40	4	29	M16	43	17	 SD.1204.	 1060-M4x9	 HTA-T15
HFM-SD1204-D32-M16-L43-Z02-H	32	2	29	M16	43	17			
HFM-SD1204-D40-M16-L43-Z03-H	40	3	29	M16	43	17			





ZCC Compatible With

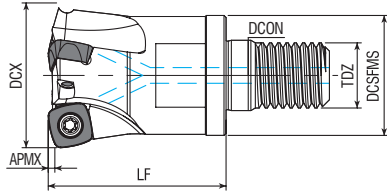

 Takım Kodu Ordering Code Bestell-Bezeichnung	Takım Ölçüleri (mm) Dimension (mm) Abmessung (mm)						Kesici Uç Insert Wendeschnei Platte	Sıkma Vidası Screw Schraube	Anahtar Allen Key Torx Schlüssel
	DC	Z	DCSFMS	TDZ	LF	DCON			
HFM-SO1004-D32-M16-L43-Z03-H	32	3	29	M16	43	17	 SOMT1004..	 1060-M4x9	 HTA-T15
HFM-SO1004-D35-M16-L43-Z03-H	35	3	29	M16	43	17			
HFM-SO1004-D40-M16-L43-Z04-H	40	4	29	M16	43	17			
HFM-SO1004-D42-M16-L43-Z04-H	42	4	29	M16	43	17			





KYCR Compatible With

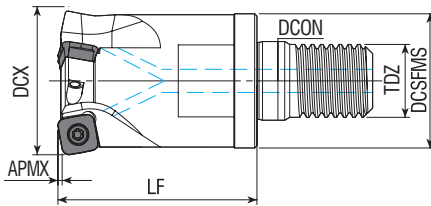

 Takım Kodu Ordering Code Bestell-Bezeichnung	Takım Ölçüleri (mm) Dimension (mm) Abmessung (mm)						Kesici Uç Insert Wendeschnei Platte	Sıkma Vidası Screw Schraube	Anahtar Allen Key Torx Schlüssel
	DC	Z	DCSFMS	TDZ	LF	DCON			
HFM-R210.09-D25-M12-L35-Z02-H	25	2	21	M12	35	12.5	 R210.09.	 1060-M3.5x9	 HTA-T15
HFM-R210.09-D32-M16-L43-Z03-H	32	3	29	M16	43	17			
HFM-R210.09-D35-M16-L43-Z03-H	35	3	29	M16	43	17			

SNVK Compatible With





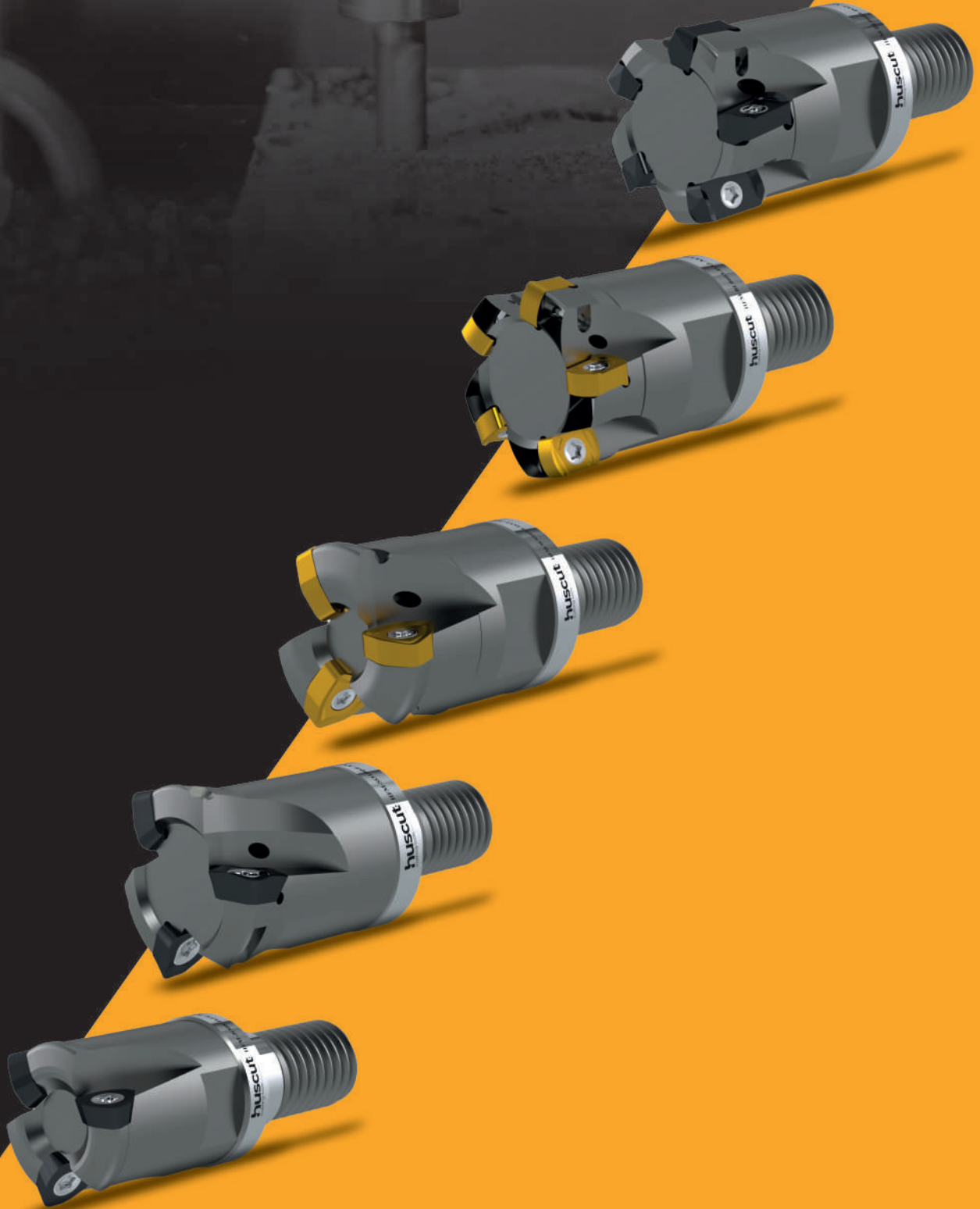

 Takım Kodu Ordering Code Bestell-Bezeichnung	Takım Ölçüleri (mm) Dimension (mm) Abmessung (mm)						Kesici Uç Insert Wendeschnei Platte	Sıkma Vidası Screw Schraube	Anahtar Allen Key Torx Schlüssel
	DC	Z	DCSFMS	TDZ	LF	DCON			
HFM-SD1205-D32-M16-L43-Z03-H	32	3	29	M16	43	17	 SD. 1205..	 1060-M4x11	 HTA-T15
HFM-SD1205-D35-M16-L43-Z03-H	35	3	29	M16	43	17			
HFM-SD1205-D40-M16-L43-Z03-H	40	3	29	M16	43	17			
HFM-SD1205-D42-M16-L43-Z03-H	42	3	29	M16	43	17			

HTCH Compatible With

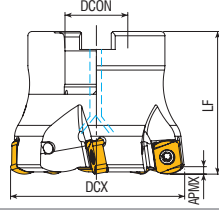
Perfect
Cut







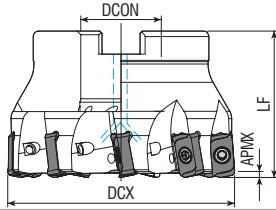

 Takım Kodu Ordering Code Bestell-Bezeichnung	Takım Ölçüleri (mm) Dimension (mm) Abmessung (mm)				Kesici Uç Insert Wendeschnei Platte	Sıkma Vidası Screw Schrauble	Anahtar Allen Key Torx Schlüssel
	DC	Z	DCON	LF			
HFM-BL0603-D040-A16-Z06-H	40	6	16	40	BLMP 0603.	1060-M2.5x6	HTA-T08
HFM-BL0603-D050-A22-Z07-H	50	7	22	40			
HFM-BL0904-D040-A16-Z05-H	40	5	16	40	BLMP 0904.	1070-M3.5x8	HTA-T10
HFM-BL0904-D050-A22-Z06-H	50	6	22	50			
HFM-BL0904-D063-A22-Z07-H	63	7	22	50			





TGT-C Compatible With

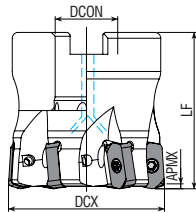

 Takım Kodu Ordering Code Bestell-Bezeichnung	Takım Ölçüleri (mm) Dimension (mm) Abmessung (mm)				Kesici Uç Insert Wendeschnei Platte	Sıkma Vidası Screw Schrauble	Anahtar Allen Key Torx Schlüssel
	DC	Z	DCON	LF			
HFM-LO03-D040-A16-Z06-H	40	6	16	40	LOGU 0303.	1070-M3x6.8	HTA-T08
HFM-LO03-D050-A22-Z07-H	50	7	22	40			
HFM-LO03-D063-A22-Z09-H	63	9	22	40			





KYR-C Compatible With

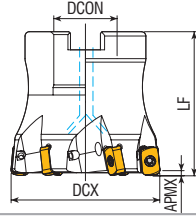

 Takım Kodu Ordering Code Bestell-Bezeichnung	Takım Ölçüleri (mm) Dimension (mm) Abmessung (mm)				Kesici Uç Insert Wendeschnei Platte	Sıkma Vidası Screw Schrauble	Anahtar Allen Key Torx Schlüssel
	DC	Z	DCON	LF			
HFM-LN0303-D040-A16-Z06-H	40	6	16	40	LNMU 0303.	1060-M2.5x6	HTA-T08
HFM-LN0303-D050-A22-Z07-H	50	7	22	50			
HFM-LN0303-D063-A22-Z09-H	63	9	22	50			





TNG-C Compatible With



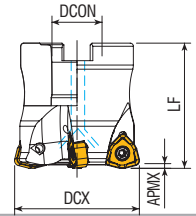



 Takım Kodu Ordering Code Bestell-Bezeichnung	Takım Ölçüleri (mm) Dimension (mm) Abmessung (mm)				Kesici Uç Insert Wendeschnei Platte	Sıkma Vidası Screw Schrauble	Anahtar Allen Key Torx Schlüssel
	DC	Z	DCON	LF			
HFM-EN1004-D040-A16-Z05-H	50	5	22	50	ENMU1004.	1060-M2.5x6	HTA-T08
HFM-EN1004-D050-A22-Z06-H	50	6	22	50			
HFM-EN1004-D063-A22-Z09-H	63	9	22	50			

D/T Compatible With

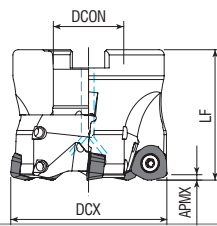

 Takım Kodu Ordering Code Bestell-Bezeichnung	Takım Ölçüleri (mm) Dimension (mm) Abmessung (mm)				Kesici Uç Insert Wendeschnei Platte	Sıkma Vidası Screw Schrauble	Anahtar Allen Key Torx Schlüssel
	DC	Z	DCON	LF			
HFM-WN09T3-D040-A16-Z04-H	40	4	16	40	WNMX09T3.	1060-M3x8	HTA-T10
HFM-WN09T3-D050-A22-Z05-H	50	5	22	40			
HFM-WN09T3-D052-A22-Z05-H	50	5	22	40			
HFM-WN09T3-D063-A22-Z06-H	63	6	22	40			





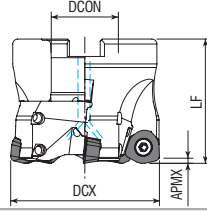

 Takım Kodu Ordering Code Bestell-Bezeichnung	Takım Ölçüleri (mm) Dimension (mm) Abmessung (mm)				Kesici Uç Insert Wendeschnei Platte	Sıkma Vidası Screw Schrauble	Anahtar Allen Key Torx Schlüssel
	DC	Z	DCON	LF			
HFM-WD08-D040-A16-Z04-H	40	4	16	40	WDMT0804.	1060-M3x8	HTA-T08
HFM-WD08-D050-A22-Z04-H	50	4	22	50			
HFM-WD1205-D050-A22-Z04-H	50	4	22	50	WDMT1205.	1060-M4x9	HTA-T15
HFM-WD1205-D052-A22-Z04-H	52	4	22	50			
HFM-WD1205-D063-A22-Z05-H	63	5	22	50			

SMTM Compatible With







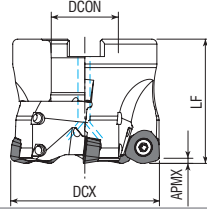

 Takım Kodu Ordering Code Bestell-Bezeichnung	Takım Ölçüleri (mm) Dimension (mm) Abmessung (mm)				Kesici Uç Insert Wendeschnei Platte	Sıkma Vidası Screw Schraube	Anahtar Allen Key Torx Schlüssel
	DC	Z	DCON	LF			
HFM-WD06T3-D040-A16-Z04-H	40	4	16	45			
HFM-WD06T3-D050-A22-Z05-H	50	5	22	50	WDW 06T3..	1070-M3.5x8	HTA-T10
HFM-WD0805-D050-A22-Z04-H	50	4	22	50	WDW 0805..		
HFM-WD0805-D063-A22-Z05-H	63	5	22	50		1060-M5x12	HTA-T20
HFM-WD10X6-D125-B40-Z06	125	6	40	63	WDW 10X6..		
HFM-WD10X6-D160-C40-Z07	160	7	40	63			





DTI Compatible With

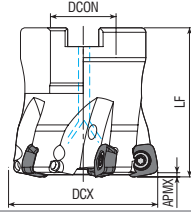

 Takım Kodu Ordering Code Bestell-Bezeichnung	Takım Ölçüleri (mm) Dimension (mm) Abmessung (mm)				Kesici Uç Insert Wendeschnei Platte	Sıkma Vidası Screw Schraube	Anahtar Allen Key Torx Schlüssel
	DC	Z	DCON	LF			
HFM-JO08-D040-A16-Z04-H	40	4	16	40			
HFM-JO08-D040-A16-Z05-H	40	5	16	40	JOMT 0803..	1060-M3x8	HTA-T08
HFM-JO08-D050-A22-Z05-H	50	5	22	40			
HFM-JD09-D040-A16-Z04-H	40	4	16	40	JDM. 09T3..	1060-M3.5x9	
HFM-JD09-D050-A22-Z05-H	50	5	22	40			HTA-T15
HFM-JD12-D050-A22-Z04-H	50	4	22	40	JDMW 1204..	1060-M4x9	
HFM-JD12-D063-A22-Z05-H	63	5	22	40			





MTSBH Compatible With

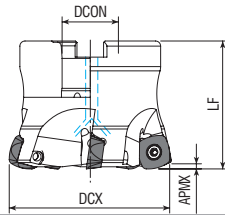

 Takım Kodu Ordering Code Bestell-Bezeichnung	Takım Ölçüleri (mm) Dimension (mm) Abmessung (mm)				Kesici Uç Insert Wendeschnei Platte	Sıkma Vidası Screw Schrauble	Anahtar Allen Key Torx Schlüssel
	DC	Z	DCON	LF			
HFM-SD09T3-D040-A16-Z04-H	40	4	16	40	SD. 09T3.	1070-M3.5x8	HTA-T15
HFM-SD09T3-D050-A22-Z05-H	50	5	22	40			
HFM-SD09T3-D063-A22-Z06-H	63	6	22	40			
HFM-SD1204-D050-A22-Z04-H	50	4	22	40	SD. 1204.	1060-M4x9	HTA-T15
HFM-SD1204-D063-A22-Z05-H	63	5	22	40			
HFM-SD1204-D080-A27-Z06-H	80	6	27	50			
HFM-SD1204-D100-A32-Z08-H	100	8	32	50			





ZCC Compatible With

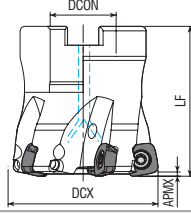

 Takım Kodu Ordering Code Bestell-Bezeichnung	Takım Ölçüleri (mm) Dimension (mm) Abmessung (mm)				Kesici Uç Insert Wendeschnei Platte	Sıkma Vidası Screw Schrauble	Anahtar Allen Key Torx Schlüssel
	DC	Z	DCON	LF			
HFM-SD1205-D050-A22-Z04-H	50	4	22	50	SD. 1205.	1060-M4x11	HTA-T15
HFM-SD1205-D052-A22-Z05-H	52	5	22	50			
HFM-SD1205-D063-A22-Z05-H	63	5	22	50			
HFM-SD1205-D066-A22-Z05-H	66	5	22	50			
HFM-SD1205-D080-A27-Z06-H	80	6	27	70			





HTCH Compatible With

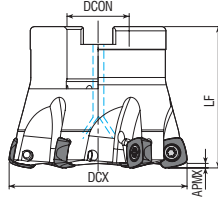

 Takım Kodu Ordering Code Bestell-Bezeichnung	Takım Ölçüleri (mm) Dimension (mm) Abmessung (mm)				Kesici Uç Insert Wendeschnei Platte	Sıkma Vidası Screw Schraube	Anahtar Allen Key Torx Schlüssel
	DC	Z	DCON	LF			
HFM-SO1004-D040-A16-Z04-H	40	4	16	40	SOMT 1004.	1060-M4x9	HTA-T15
HFM-SO1004-D050-A22-Z05-H	50	5	22	40			
HFM-SO1004-D063-A22-Z06-H	63	6	22	40			
HFM-SO1004-D080-A27-Z07-H	80	7	27	50			





IKCR Compatible With

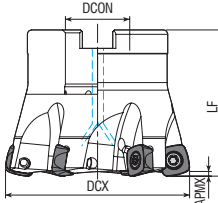

 Takım Kodu Ordering Code Bestell-Bezeichnung	Takım Ölçüleri (mm) Dimension (mm) Abmessung (mm)				Kesici Uç Insert Wendeschnei Platte	Sıkma Vidası Screw Schraube	Anahtar Allen Key Torx Schlüssel
	DC	Z	DCON	LF			
HFM-R210.09-D040-A16-Z04-H	40	4	16	40	R210.09.	1060-M3.5x9	HTA-T15
HFM-R210.09-D050-A22-Z05-H	50	5	22	40			
HFM-R210.09-D063-A22-Z06-H	63	6	22	40			

SND/K Compatible With



 Takım Kodu Ordering Code Bestell-Bezeichnung	Takım Ölçüleri (mm) Dimension (mm) Abmessung (mm)				Kesici Uç Insert Wendeschnei Platte	Sıkma Vidası Screw Schraube	Anahtar Allen Key Torx Schlüssel
	DC	Z	DCON	LF			
HFM-SP1004-D050-A22-Z05-H	50	5	22	50	SPNW 1004.	1060-M3.5x9	HTA-T15
HFM-SP1004-D052-A22-Z05-H	52	5	22	50			
HFM-SP1004-D063-A22-Z06-H	63	6	22	50			

DT Compatible With

Perfect
Cut





Takma Uçlu Matkaplar

U-Drill
U-Drill

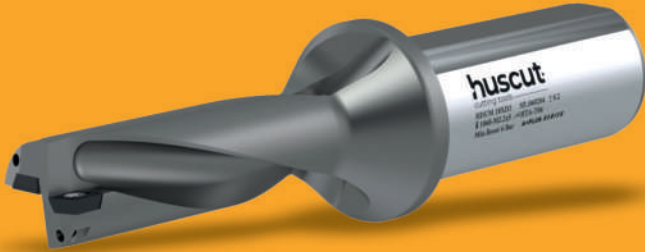
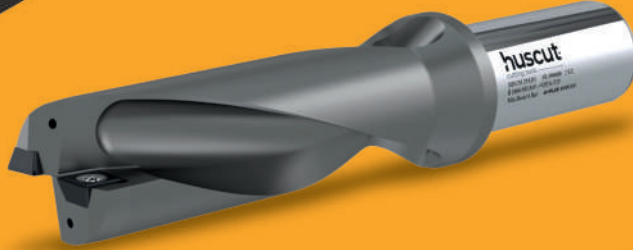

H

TUM

18

D3

» 1

Marka
Brand
Marke

huscut

» 2

Kesici Stili
Cutter Style
Cutter-Stil

Takma Uçlu Matkap
U-Drill
Vollbohrer

TUM

» 3

Takım Çapı
Tool Diameter
Werkzeugdurchmesser

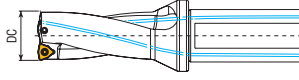

» 4

Delme Derinliği
Drilling Depth
Bohrtiefe

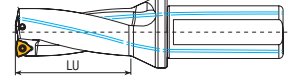

S

P

M

G

06

02

04

» 5

Uç Şekli
Insert Form
Plattenform



S



W

» 6

Serbest Uç Açısı
Clearance angle of Insert
Freiwinkel der Wendschneidplatte



C



P

» 7

Toleranslar
Tolerance Classes
Toleranzen

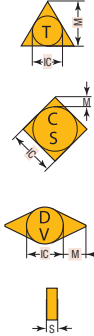

	IC	M	S
A	±0.025	±0.005	±0.025
C	±0.025	±0.013	±0.025
E	±0.025	±0.025	±0.025
F	±0.013	±0.005	±0.025
G	±0.025	±0.025	±0.130
H	±0.013	±0.013	±0.025
J	±0.005-0.15	±0.005	±0.025
K	±0.005-0.15	±0.013	±0.025
L	±0.005-0.15	±0.025	±0.025
M	±0.005-0.15	±0.08-0.20	±0.130
N	±0.005-0.15	±0.08-0.20	±0.025
U	±0.008-0.25	±0.013-0.38	±0.130

Daire Ölçüsü
Inscribed Circle
Kreisgröße

IC

Şekle Göre
Refer to Figure
Siehe Abbildung

M

Kalınlık
Thickness
Dicke

S

» 8

Uç Tipi
Type Of Insert
Plattenform

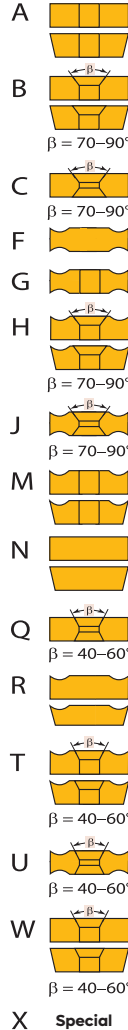

» 9

Kenar Uzunluğu
Edge Length
Schneidkantenlänge

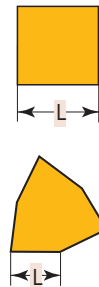

» 10

Kalınlık
Thickness
Dicke

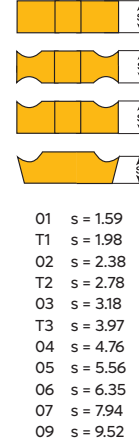



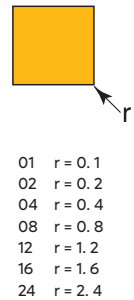

» 11



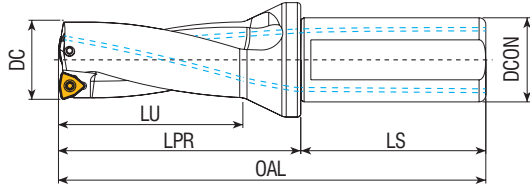
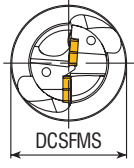

Köşe Konfigürasyonu
Corner Radius
Eckenradius







01	r = 0.1
02	r = 0.2
04	r = 0.4
08	r = 0.8
12	r = 1.2
16	r = 1.6
24	r = 2.4



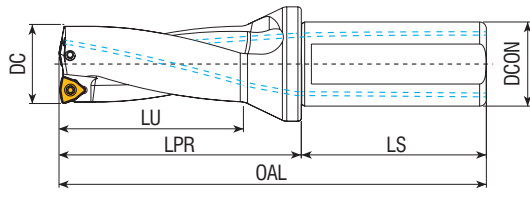



 Takım Kodu Ordering Code Bestell-Bezeichnung	Takım Ölçüleri (mm) Dimension (mm) Abmessung (mm)							Kesici Uç Insert Wendeschnei-Platte	Sıkma Vidası Screw Schraube	Anahtar Allen Key Torx Schlüssel
	DC	DCON	DCSFMS	OAL	LU	LPR	LS			
HTUM 16XD2 WCM. 030208	16	25	34	110	32	54	56	WCM. 030208	1060-M2.5x7	
HTUM 16.5XD2 WCM. 030208	16.5	25	34	110	32	54	56			
HTUM 17XD2 WCM. 030208	17	25	34	112	34	56	56			
HTUM 17.5XD2 WCM. 030208	17.5	25	34	112	34	56	56			
HTUM 18XD2 WCM. 030208	18	25	34	114	36	58	56			
HTUM 18.5XD2 WCM. 030208	18.5	25	34	114	36	58	56			
HTUM 19XD2 WCM. 030208	19	25	34	116	38	60	56			
HTUM 19.5XD2 WCM. 030208	19.5	25	34	116	38	60	56			
HTUM 20XD2 WCM. 040208	20	25	34	118	40	62	56	WCM. 040208	1060-M2.5x7	HTA-T08
HTUM 20.5XD2 WCM. 040208	20.5	25	34	118	40	62	56			
HTUM 21XD2 WCM. 040208	21	25	34	120	42	64	56			
HTUM 21.5XD2 WCM. 040208	21.5	25	34	120	42	64	56			
HTUM 22XD2 WCM. 040208	22	25	34	122	44	66	56			
HTUM 22.5XD2 WCM. 040208	22.5	25	34	122	44	66	56			
HTUM 23XD2 WCM. 040208	23	25	34	124	46	68	56			
HTUM 23.5XD2 WCM. 040208	23.5	25	34	124	46	68	56			
HTUM 24XD2 WCM. 050308	24	25	34	126	48	70	56	WCM. 050308	1060-M3x8	
HTUM 24.5XD2 WCM. 050308	24.5	25	34	126	48	70	56			
HTUM 25XD2 WCM. 050308	25	25	34	128	50	72	56			
HTUM 25.5XD2 WCM. 050308	25.5	25	34	128	50	72	56			
HTUM 26XD2 WCM. 050308	26	25	34	130	52	74	56			
HTUM 26.5XD2 WCM. 050308	26.5	25	34	130	52	74	56			
HTUM 27XD2 WCM. 050308	27	25	34	132	54	76	56			
HTUM 27.5XD2 WCM. 050308	27.5	25	34	132	54	76	56			
HTUM 28XD2 WCM. 050308	28	25	34	134	56	78	56			
HTUM 28.5XD2 WCM. 050308	28.5	25	34	134	56	78	56			
HTUM 29XD2 WCM. 050308	29	25	34	136	58	80	56			
HTUM 29.5XD2 WCM. 050308	29.5	25	34	136	58	80	56			









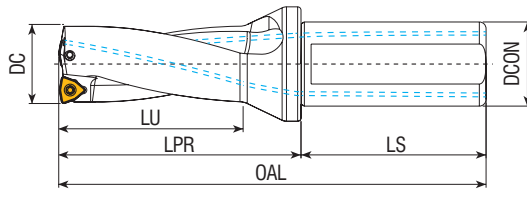
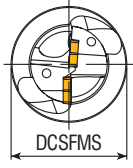

 Takım Kodu Ordering Code Bestell-Bezeichnung	Takım Ölçüleri (mm) Dimension (mm) Abmessung (mm)							Kesici Uç Insert Wendeschnelplatte	Sıkma Vidası Screw Schraube	Anahtar Allen Key Torx Schlüssel
	DC	DCON	DCSfMS	OAL	LU	LPR	LS			
HTUM 30XD2 WCM. 06T308	30	32	44	147	60	87	60	WCM. 06T308	1060-M3.5x9	
HTUM 31XD2 WCM. 06T308	31	32	44	149	62	89	60			
HTUM 32XD2 WCM. 06T308	32	32	44	151	64	91	60			
HTUM 33XD2 WCM. 06T308	33	32	44	153	66	93	60			
HTUM 34XD2 WCM. 06T308	34	32	44	155	68	95	60			
HTUM 35XD2 WCM. 06T308	35	32	44	157	70	97	60			
HTUM 36XD2 WCM. 06T308	36	32	44	159	72	99	60			
HTUM 37XD2 WCM. 06T308	37	32	44	161	74	101	60			
HTUM 38XD2 WCM. 06T308	38	32	44	163	76	103	60			
HTUM 39XD2 WCM. 06T308	39	32	44	165	78	105	60			
HTUM 40XD2 WCM. 06T308	40	32	44	167	80	107	60			
HTUM 41XD2 WCM. 06T308	41	32	44	169	82	109	60			
HTUM 42XD2 WCM. 06T308	42	32	44	171	84	111	60			
HTUM 43XD2 WCM. 06T308	43	32	44	173	86	113	60			
HTUM 44XD2 WCM. 06T308	44	32	44	175	88	115	60			
HTUM 45XD2 WCM. 080412	45	40	54	192	90	122	70	WCM. 080412	1060-M4x11	HTA-T15
HTUM 46XD2 WCM. 080412	46	40	54	194	92	124	70			
HTUM 47XD2 WCM. 080412	47	40	54	196	94	126	70			
HTUM 48XD2 WCM. 080412	48	40	54	198	96	128	70			
HTUM 49XD2 WCM. 080412	49	40	54	200	98	130	70			
HTUM 50XD2 WCM. 080412	50	40	54	202	100	132	70			
HTUM 51XD2 WCM. 080412	51	40	54	204	102	134	70			
HTUM 52XD2 WCM. 080412	52	40	54	206	104	136	70			
HTUM 53XD2 WCM. 080412	53	40	54	208	106	138	70			
HTUM 54XD2 WCM. 080412	54	40	54	210	108	140	70			
HTUM 55XD2 WCM. 080412	55	40	54	212	110	142	70			
HTUM 56XD2 WCM. 080412	56	40	64	214	112	144	70			
HTUM 57XD2 WCM. 080412	57	40	64	216	114	146	70			
HTUM 58XD2 WCM. 080412	58	40	64	218	116	148	70			
HTUM 59XD2 WCM. 080412	59	40	64	220	118	150	70			
HTUM 60XD2 WCM. 080412	60	40	64	222	120	152	70			







 Takım Kodu Ordering Code Bestell-Bezeichnung	Takım Ölçüleri (mm) Dimension (mm) Abmessung (mm)							Kesici Uç Insert Wendschnei Platte	Sıkma Vidası Screw Schraube	Anahtar Allen Key Torx Schlüssel
	DC	DCON	DCSFMS	OAL	LU	LPR	LS			
HTUM 16XD3 WCM. 030208	16	25	34	126	48	70	56	WCM. 030208	1060-M2.5x7	HTA-T08
HTUM 16.5XD3 WCM. 030208	16.5	25	34	126	48	70	56			
HTUM 17XD3 WCM. 030208	17	25	34	129	51	73	56			
HTUM 17.5XD3 WCM. 030208	17.5	25	34	129	51	73	56			
HTUM 18XD3 WCM. 030208	18	25	34	132	54	76	56			
HTUM 18.5XD3 WCM. 030208	18.5	25	34	132	54	76	56			
HTUM 19XD3 WCM. 030208	19	25	34	135	57	79	56			
HTUM 19.5XD3 WCM. 030208	19.5	25	34	135	57	79	56			
HTUM 20XD3 WCM. 040208	20	25	34	138	60	82	56	WCM. 040208	1060-M2.5x7	HTA-T08
HTUM 20.5XD3 WCM. 040208	20.5	25	34	138	60	82	56			
HTUM 21XD3 WCM. 040208	21	25	34	141	63	85	56			
HTUM 21.5XD3 WCM. 040208	21.5	25	34	141	63	85	56			
HTUM 22XD3 WCM. 040208	22	25	34	144	66	88	56			
HTUM 22.5XD3 WCM. 040208	22.5	25	34	144	66	88	56			
HTUM 23XD3 WCM. 040208	23	25	34	147	69	91	56			
HTUM 23.5XD3 WCM. 040208	23.5	25	34	147	69	91	56			
HTUM 24XD3 WCM. 050308	24	25	34	150	72	94	56	WCM. 050308	1060-M3x8	HTA-T08
HTUM 24.5XD3 WCM. 050308	24.5	25	34	150	72	94	56			
HTUM 25XD3 WCM. 050308	25	25	34	153	75	97	56			
HTUM 25.5XD3 WCM. 050308	25.5	25	34	153	75	97	56			
HTUM 26XD3 WCM. 050308	26	25	34	156	78	100	56			
HTUM 26.5XD3 WCM. 050308	26.5	25	34	156	78	100	56			
HTUM 27XD3 WCM. 050308	27	25	34	159	81	103	56			
HTUM 27.5XD3 WCM. 050308	27.5	25	34	159	81	103	56			
HTUM 28XD3 WCM. 050308	28	25	34	162	84	106	56			
HTUM 28.5XD3 WCM. 050308	28.5	25	34	162	84	106	56			
HTUM 29XD3 WCM. 050308	29	25	34	165	87	109	56			
HTUM 29.5XD3 WCM. 050308	29.5	25	34	165	87	109	56			





 Takım Kodu Ordering Code Bestell-Bezeichnung	Takım Ölçüleri (mm) Dimension (mm) Abmessung (mm)							Kesici Uç Insert Wendeschnei Platte	Sıkma Vidası Screw Schrauble	Anahtar Allen Key Torx Schlüssel			
	DC	DCON	DCSFMS	OAL	LU	LPR	LS						
HTUM 30XD3 WCM. 06T308	30	32	44	177	90	117	60	WCM.06T308	1060-M3.5x9	HTA-T15			
HTUM 30.5XD3 WCM. 06T308	30.5	32	44	177	90	117	60						
HTUM 31XD3 WCM. 06T308	31	32	44	180	93	120	60						
HTUM 31.5XD3 WCM. 06T308	31.5	32	44	180	93	120	60						
HTUM 32XD3 WCM. 06T308	32	32	44	183	96	123	60						
HTUM 32.5XD3 WCM. 06T308	32.5	32	44	183	96	123	60						
HTUM 33XD3 WCM. 06T308	33	32	44	186	99	126	60						
HTUM 33.5XD3 WCM. 06T308	33.5	32	44	186	99	126	60						
HTUM 34XD3 WCM. 06T308	34	32	44	189	102	129	60						
HTUM 34.5XD3 WCM. 06T308	34.5	32	44	189	102	129	60						
HTUM 35XD3 WCM. 06T308	35	32	44	192	105	132	60						
HTUM 35.5XD3 WCM. 06T308	35.5	32	44	192	105	132	60						
HTUM 36XD3 WCM. 06T308	36	32	44	195	108	135	60						
HTUM 36.5XD3 WCM. 06T308	36.5	32	44	195	108	135	60						
HTUM 37XD3 WCM. 06T308	37	32	44	198	111	138	60						
HTUM 37.5XD3 WCM. 06T308	37.5	32	44	198	111	138	60						
HTUM 38XD3 WCM. 06T308	38	32	44	201	114	141	60						
HTUM 38.5XD3 WCM. 06T308	38.5	32	44	201	114	141	60						
HTUM 39XD3 WCM. 06T308	39	32	44	204	117	144	60						
HTUM 39.5XD3 WCM. 06T308	39.5	32	44	204	117	144	60						
HTUM 40XD3 WCM. 06T308	40	32	44	207	120	147	60						
HTUM 41XD3 WCM. 06T308	41	32	44	210	123	150	60						
HTUM 42XD3 WCM. 06T308	42	32	44	213	126	153	60						
HTUM 43XD3 WCM. 06T308	43	32	44	216	129	156	60						
HTUM 44XD3 WCM. 06T308	44	32	44	219	132	159	60						
HTUM 45XD3 WCM. 080412	45	40	54	237	135	167	70				WCM.080412	1060-M4x11	HTA-T15
HTUM 46XD3 WCM. 080412	46	40	54	240	138	170	70						
HTUM 47XD3 WCM. 080412	47	40	54	243	141	173	70						
HTUM 48XD3 WCM. 080412	48	40	54	246	144	176	70						
HTUM 49XD3 WCM. 080412	49	40	54	249	147	179	70						
HTUM 50XD3 WCM. 080412	50	40	54	252	150	182	70						
HTUM 51XD3 WCM. 080412	51	40	54	255	153	185	70						
HTUM 52XD3 WCM. 080412	52	40	54	258	156	188	70						
HTUM 53XD3 WCM. 080412	53	40	54	261	159	191	70						
HTUM 54XD3 WCM. 080412	54	40	54	264	162	194	70						
HTUM 55XD3 WCM. 080412	55	40	54	267	165	197	70						
HTUM 56XD3 WCM. 080412	56	40	64	270	168	200	70						
HTUM 57XD3 WCM. 080412	57	40	64	273	171	203	70						
HTUM 58XD3 WCM. 080412	58	40	64	276	174	206	70						
HTUM 59XD3 WCM. 080412	59	40	64	279	177	209	70						
HTUM 60XD3 WCM. 080412	60	40	64	282	180	212	70						

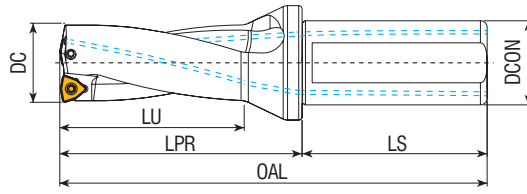
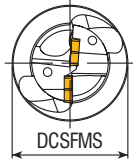

 Takım Kodu Ordering Code Bestell-Bezeichnung	Takım Ölçüleri (mm) Dimension (mm) Abmessung (mm)							Kesici Uç Insert Wendeschnei Platte	Sıkma Vidası Screw Schraube	Anahtar Allen Key Torx Schlüssel
	DC	DCON	DCSFMS	OAL	LU	LPR	LS			
HTUM 16XD4 WCM. 030208	16	25	34	142	64	86	56	WCM. 030208		
HTUM 16.5XD4 WCM. 030208	16.5	25	34	142	64	86	56			
HTUM 17XD4 WCM. 030208	17	25	34	146	68	90	56			
HTUM 17.5XD4 WCM. 030208	17.5	25	34	146	68	90	56			
HTUM 18XD4 WCM. 030208	18	25	34	150	72	94	56			
HTUM 18.5XD4 WCM. 030208	18.5	25	34	150	72	94	56			
HTUM 19XD4 WCM. 030208	19	25	34	154	76	98	56			
HTUM 19.5XD4 WCM. 030208	19.5	25	34	154	76	98	56	1060-M2.5x7		
HTUM 20XD4 WCM. 040208	20	25	34	158	80	102	56			
HTUM 20.5XD4 WCM. 040208	20.5	25	34	158	80	102	56			
HTUM 21XD4 WCM. 040208	21	25	34	162	84	106	56			
HTUM 21.5XD4 WCM. 040208	21.5	25	34	162	84	106	56			
HTUM 22XD4 WCM. 040208	22	25	34	166	88	110	56			
HTUM 22.5XD4 WCM. 040208	22.5	25	34	166	88	110	56			
HTUM 23XD4 WCM. 040208	23	25	34	170	92	114	56	WCM. 040208		
HTUM 23.5XD4 WCM. 040208	23.5	25	34	170	92	114	56			
HTUM 24XD4 WCM. 050308	24	25	34	174	96	118	56			
HTUM 24.5XD4 WCM. 050308	24.5	25	34	174	96	118	56			
HTUM 25XD4 WCM. 050308	25	25	34	178	100	122	56			
HTUM 25.5XD4 WCM. 050308	25.5	25	34	178	100	122	56			
HTUM 26XD4 WCM. 050308	26	25	34	182	104	126	56			
HTUM 26.5XD4 WCM. 050308	26.5	25	34	182	104	126	56	WCM. 050308		
HTUM 27XD4 WCM. 050308	27	25	34	186	108	130	56			
HTUM 27.5XD4 WCM. 050308	27.5	25	34	186	108	130	56			
HTUM 28XD4 WCM. 050308	28	25	34	190	112	134	56			
HTUM 28.5XD4 WCM. 050308	28.5	25	34	190	112	134	56			
HTUM 29XD4 WCM. 050308	29	25	34	194	116	138	56			
HTUM 29.5XD4 WCM. 050308	29.5	25	34	194	116	138	56			







 Takım Kodu Ordering Code Bestell-Bezeichnung	Takım Ölçüleri (mm) Dimension (mm) Abmessung (mm)							Kesici Uç Insert Wendeschnei Platte	Sıkma Vidası Screw Schrauble	Anahtar Allen Key Torx Schlüssel
	DC	DCON	DCSFMS	OAL	LU	LPR	LS			
HTUM 30XD4 WCM. 06T308	30	32	44	207	120	147	60	WCM.06T308	1060-M3.5x9	HTA-T15
HTUM 31XD4 WCM. 06T308	31	32	44	211	124	151	60			
HTUM 32XD4 WCM. 06T308	32	32	44	215	128	155	60			
HTUM 33XD4 WCM. 06T308	33	32	44	219	132	159	60			
HTUM 34XD4 WCM. 06T308	34	32	44	223	136	163	60			
HTUM 35XD4 WCM. 06T308	35	32	44	227	140	167	60			
HTUM 36XD4 WCM. 06T308	36	32	44	231	144	171	60			
HTUM 37XD4 WCM. 06T308	37	32	44	235	148	175	60			
HTUM 38XD4 WCM. 06T308	38	32	44	239	152	179	60			
HTUM 39XD4 WCM. 06T308	39	32	44	243	156	183	60			
HTUM 40XD4 WCM. 06T308	40	32	44	247	160	187	60			
HTUM 41XD4 WCM. 06T308	41	32	44	251	164	191	60			
HTUM 42XD4 WCM. 06T308	42	32	44	255	168	195	60			
HTUM 43XD4 WCM. 06T308	43	32	44	259	172	199	60			
HTUM 44XD4 WCM. 06T308	44	32	44	263	176	203	60			
HTUM 45XD4 WCM. 080412	45	40	54	282	180	212	70	WCM.080412	1060-M4x11	
HTUM 46XD4 WCM. 080412	46	40	54	286	184	216	70			
HTUM 47XD4 WCM. 080412	47	40	54	290	188	220	70			
HTUM 48XD4 WCM. 080412	48	40	54	294	192	224	70			
HTUM 49XD4 WCM. 080412	49	40	54	298	196	228	70			
HTUM 50XD4 WCM. 080412	50	40	54	302	200	232	70			

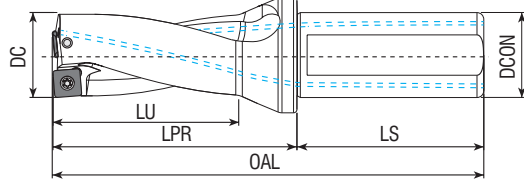
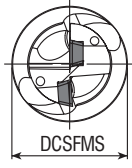





 Takım Kodu Ordering Code Bestell-Bezeichnung	Takım Ölçüleri (mm) Dimension (mm) Abmessung (mm)							Kesici Uç Insert Wendschnei Platte	Sıkma Vidası Screw Schraube	Anahtar Allen Key Torx Schlüssel
	DC	DCON	DCSFMS	OAL	LU	LPR	LS			
HTUM 16XD5 WCM. 030208	16	25	34	158	80	102	56	WCM.030208	1060-M2.5x7	HTA-T08
HTUM 17XD5 WCM. 030208	17	25	34	163	85	107	56			
HTUM 18XD5 WCM. 030208	18	25	34	168	90	112	56			
HTUM 19XD5 WCM. 030208	19	25	34	173	95	117	56			
HTUM 20XD5 WCM. 040208	20	25	34	178	100	122	56	WCM.040208	1060-M2.5x7	HTA-T08
HTUM 21XD5 WCM. 040208	21	25	34	183	105	127	56			
HTUM 22XD5 WCM. 040208	22	25	34	188	110	132	56			
HTUM 23XD5 WCM. 040208	23	25	34	193	115	137	56			
HTUM 24XD5 WCM. 050308	24	25	34	198	120	142	56	WCM.050308	1060-M3x8	HTA-T15
HTUM 25XD5 WCM. 050308	25	25	34	203	125	147	56			
HTUM 26XD5 WCM. 050308	26	25	34	208	130	152	56			
HTUM 27XD5 WCM. 050308	27	25	34	213	135	157	56			
HTUM 28XD5 WCM. 050308	28	25	34	218	140	162	56			
HTUM 29XD5 WCM. 050308	29	25	34	223	145	167	56			
HTUM 30XD5 WCM. 06T308	30	32	44	237	150	177	60	WCM.06T308	1060-M3.5x9	HTA-T15
HTUM 31XD5 WCM. 06T308	31	32	44	242	155	182	60			
HTUM 32XD5 WCM. 06T308	32	32	44	247	160	187	60			
HTUM 33XD5 WCM. 06T308	33	32	44	252	165	192	60			
HTUM 34XD5 WCM. 06T308	34	32	44	257	170	197	60			
HTUM 35XD5 WCM. 06T308	35	32	44	262	175	202	60			
HTUM 36XD5 WCM. 06T308	36	32	44	268	180	207	60			
HTUM 37XD5 WCM. 06T308	37	32	44	272	185	212	60			
HTUM 38XD5 WCM. 06T308	38	32	44	277	190	217	60			
HTUM 39XD5 WCM. 06T308	39	32	44	282	195	222	60			
HTUM 40XD5 WCM. 06T308	40	32	44	287	200	227	60			









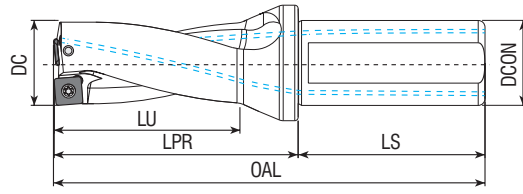
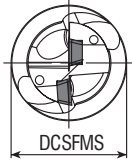





 Takım Kodu Ordering Code Bestell-Bezeichnung	Takım Ölçüleri (mm) Dimension (mm) Abmessung (mm)							Kesici Uç Insert Wendeschnei-Platte	Sıkma Vidası Screw Schraube	Anahtar Allen Key Torx Schlüssel
	DC	DCON	DCSFMS	OAL	LU	LPR	LS			
HTUM 12.5XD2 SP..050204	12.5	20	25	96	24	46	50	SP..050204		HTA-T06
HTUM 13XD2 SP..050204	13	20	25	98	26	48	50			
HTUM 13.5XD2 SP..050204	13.5	20	25	98	26	48	50			
HTUM 14XD2 SP..050204	14	20	25	100	28	50	50			
HTUM 14.5XD2 SP..050204	13.5	20	25	100	28	50	50			
HTUM 15XD2 SP..050204	15	20	25	102	30	52	50			
HTUM 15.5XD2 SP..060204	15.5	20	25	102	30	52	50	SP..060204		HTA-T07
HTUM 16XD2 SP..060204	16	25	34	110	32	54	56			
HTUM 16.5XD2 SP..060204	16.5	25	34	110	32	54	56			
HTUM 17XD2 SP..060204	17	25	34	112	34	56	56			
HTUM 17.5XD2 SP..060204	17.5	25	34	112	34	56	56			
HTUM 18XD2 SP..060204	18	25	34	114	36	58	56			
HTUM 18.5XD2 SP..060204	18.5	25	34	114	36	58	56			
HTUM 19XD2 SP..060204	19	25	34	116	38	60	56			
HTUM 19.5XD2 SP..060204	19.5	25	34	116	38	60	56			
HTUM 20XD2 SP..060204	20	25	34	118	40	62	56			
HTUM 20.5XD2 SP..060204	20.5	25	34	118	40	62	56			
HTUM 21XD2 SP..060204	21	25	34	120	42	64	56			
HTUM 21.5XD2 SP..060204	21.5	25	34	120	42	64	56			
HTUM 22XD2 SP..07T308	22	25	34	122	44	66	56			
HTUM 22.5XD2 SP..07T308	22.5	25	34	122	44	66	56			
HTUM 23XD2 SP..07T308	23	25	34	124	46	68	56			
HTUM 23.5XD2 SP..07T308	23.5	25	34	124	46	68	56			
HTUM 24XD2 SP..07T308	24	25	34	126	48	70	56			
HTUM 24.5XD2 SP..07T308	24.5	25	34	126	48	70	56			
HTUM 25XD2 SP..07T308	25	25	34	128	50	72	56			
HTUM 25.5XD2 SP..07T308	25.5	25	34	128	50	72	56			
HTUM 26XD2 SP..07T308	26	25	34	130	52	74	56			
HTUM 26.5XD2 SP..07T308	26.5	25	34	130	52	74	56			
HTUM 27XD2 SP..07T308	27	25	34	132	54	76	56			
HTUM 27.5XD2 SP..07T308	27.5	25	34	132	54	76	56			







 Takım Kodu Ordering Code Bestell-Bezeichnung	Takım Ölçüleri (mm) Dimension (mm) Abmessung (mm)							Kesici Uç Insert Wendeschnei-Platte	Sıkma Vidası Screw Schrauble	Anahtar Allen Key Torx Schlüssel
	DC	DCON	DCSFMS	OAL	LU	LPR	LS			
HTUM 28XD2 SP. 090408	28	25	34	134	56	78	56	SP. 090408	1060-M3.5x9	HTA-T15
HTUM 28.5XD2 SP. 090408	28.5	25	34	134	56	78	56			
HTUM 29XD2 SP. 090408	29	25	34	136	58	80	56			
HTUM 29.5XD2 SP. 090408	29.5	25	34	136	58	80	56			
HTUM 30XD2 SP. 090408	30	32	44	147	60	87	60			
HTUM 31XD2 SP. 090408	31	32	44	149	62	89	60			
HTUM 32XD2 SP. 090408	32	32	44	151	64	91	60			
HTUM 33XD2 SP. 090408	33	32	44	153	66	93	60	SP. 110408	1060-M4x11	HTA-T15
HTUM 34XD2 SP. 110408	34	32	44	155	68	95	60			
HTUM 35XD2 SP. 110408	35	32	44	157	70	97	60			
HTUM 36XD2 SP. 110408	36	32	44	159	72	99	60			
HTUM 37XD2 SP. 110408	37	32	44	161	74	101	60			
HTUM 38XD2 SP. 110408	38	32	44	163	76	103	60			
HTUM 39XD2 SP. 110408	39	32	44	165	78	105	60			
HTUM 40XD2 SP. 110408	40	32	44	167	80	107	60	SP. 140512	1060-M5x11	HTA-T20
HTUM 41XD2 SP. 110408	41	32	44	169	82	109	60			
HTUM 42XD2 SP. 140512	42	32	44	171	84	111	60			
HTUM 43XD2 SP. 140512	43	32	44	173	86	113	60			
HTUM 44XD2 SP. 140512	44	32	44	175	88	115	60			
HTUM 45XD2 SP. 140512	45	40	54	192	90	122	70			
HTUM 46XD2 SP. 140512	46	40	54	194	92	124	70			
HTUM 47XD2 SP. 140512	47	40	54	196	94	126	70			
HTUM 48XD2 SP. 140512	48	40	54	198	96	128	70	SP. 140512	1060-M5x11	HTA-T20
HTUM 49XD2 SP. 140512	49	40	54	200	98	130	70			
HTUM 50XD2 SP. 140512	50	40	5	202	100	132	70			

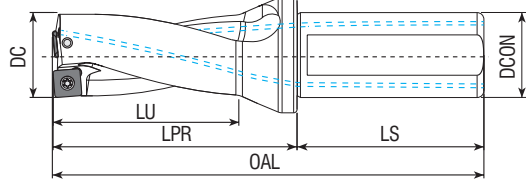
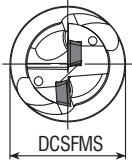





 Takım Kodu Ordering Code Bestell-Bezeichnung	Takım Ölçüleri (mm) Dimension (mm) Abmessung (mm)							Kesici Uç Insert Wendeschnei-Platte	Sıkma Vidası Screw Schraube	Anahtar Allen Key Torx Schlüssel
	DC	DCON	DCSFMS	OAL	LU	LPR	LS			
HTUM 12.5XD3 SP..050204	12.5	20	25	108	36	58	50	SP..050204		HTA-T06
HTUM 13XD3 SP..050204	13	20	25	111	39	61	50			
HTUM 13.5XD3 SP..050204	13.5	20	25	111	39	61	50			
HTUM 14XD3 SP..050204	14	20	25	114	42	64	50			
HTUM 14.5XD3 SP..050204	13.5	20	25	114	42	64	50			
HTUM 15XD3 SP..050204	15	20	25	117	45	67	50			
HTUM 15.5XD3 SP..060204	15.5	20	25	117	45	67	50	SP..060204		HTA-T07
HTUM 16XD3 SP..060204	16	25	34	126	48	70	56			
HTUM 16.5XD3 SP..060204	16.5	25	34	126	48	70	56			
HTUM 17XD3 SP..060204	17	25	34	129	51	73	56			
HTUM 17.5XD3 SP..060204	17.5	25	34	129	51	73	56			
HTUM 18XD3 SP..060204	18	25	34	132	54	76	56			
HTUM 18.5XD3 SP..060204	18.5	25	34	132	54	76	56			
HTUM 19XD3 SP..060204	19	25	34	135	57	79	56			
HTUM 19.5XD3 SP..060204	19.5	25	34	135	57	79	56			
HTUM 20XD3 SP..060204	20	25	34	138	60	82	56			
HTUM 20.5XD3 SP..060204	20.5	25	34	138	60	82	56			
HTUM 21XD3 SP..060204	21	25	34	141	63	85	56			
HTUM 21.5XD3 SP..060204	21.5	25	34	141	63	85	56			
HTUM 22XD3 SP..07T308	22	25	34	144	66	88	56	SP..07T308		HTA-T08
HTUM 22.5XD3 SP..07T308	22.5	25	34	144	66	88	56			
HTUM 23XD3 SP..07T308	23	25	34	147	69	91	56			
HTUM 23.5XD3 SP..07T308	23.5	25	34	147	69	91	56			
HTUM 24XD3 SP..07T308	24	25	34	150	72	94	56			
HTUM 24.5XD3 SP..07T308	24.5	25	34	150	72	94	56			
HTUM 25XD3 SP..07T308	25	25	34	153	75	97	56			
HTUM 25.5XD3 SP..07T308	25.5	25	34	153	75	97	56			
HTUM 26XD3 SP..07T308	26	25	34	156	78	100	56			
HTUM 26.5XD3 SP..07T308	26.5	25	34	156	78	100	56			
HTUM 27XD3 SP..07T308	27	25	34	159	81	103	56			
HTUM 27.5XD3 SP..07T308	27.5	25	34	159	81	103	56			







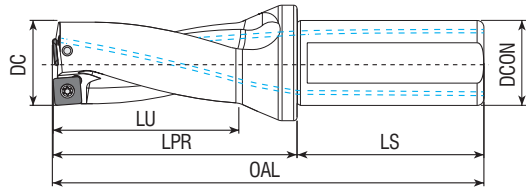
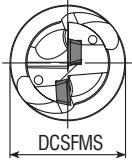

 Takım Kodu Ordering Code Bestell-Bezeichnung	Takım Ölçüleri (mm) Dimension (mm) Abmessung (mm)							Kesici Uç Insert Wendeschnei Platte	Sıkma Vidası Screw Schrauble	Anahtar Allen Key Torx Schlüssel
	DC	DCON	DCSFMS	OAL	LU	LPR	LS			
HTUM 28XD3 SP. 090408	28	25	34	162	84	106	56	SP. 090408	1060-M3.5x9	
HTUM 28.5XD3 SP. 090408	28.5	25	34	162	84	106	56			
HTUM 29XD3 SP. 090408	29	25	34	165	87	109	56			
HTUM 29.5XD3 SP. 090408	29.5	25	34	165	87	109	56			
HTUM 30XD3 SP. 090408	30	32	44	177	90	117	60			
HTUM 30.5XD3 SP. 090408	30.5	32	44	177	90	117	60			
HTUM 31XD3 SP. 090408	31	32	44	180	93	120	60			
HTUM 31.5XD3 SP. 090408	31.5	32	44	180	93	120	60			
HTUM 32XD3 SP. 090408	32	32	44	183	96	123	60			
HTUM 32.5XD3 SP. 090408	32.5	32	44	183	96	123	60			
HTUM 33XD3 SP. 090408	33	32	44	186	99	126	60			
HTUM 33.5XD3 SP. 090408	33.5	32	44	186	99	126	60			
HTUM 34XD3 SP. 110408	34	32	44	189	102	129	60	SP. 110408	1060-M4x11	HTA-T15
HTUM 34.5XD3 SP. 110408	34.5	32	44	189	102	129	60			
HTUM 35XD3 SP. 110408	35	32	44	192	105	132	60			
HTUM 35.5XD3 SP. 110408	35.5	32	44	192	105	132	60			
HTUM 36XD3 SP. 110408	36	32	44	195	108	135	60			
HTUM 36.5XD3 SP. 110408	36.5	32	44	195	108	135	60			
HTUM 37XD3 SP. 110408	37	32	44	198	111	138	60			
HTUM 37.5XD3 SP. 110408	37.5	32	44	198	111	138	60			
HTUM 38XD3 SP. 110408	38	32	44	201	114	141	60			
HTUM 38.5XD3 SP. 110408	38.5	32	44	201	114	141	60			
HTUM 39XD3 SP. 110408	39	32	44	204	117	144	60			
HTUM 39.5XD3 SP. 110408	39.5	32	44	204	117	144	60			
HTUM 40XD3 SP. 110408	40	32	44	207	120	147	60	SP. 140512	1060-M5x11	HTA-T20
HTUM 41XD3 SP. 110408	41	32	44	210	123	150	60			
HTUM 42XD3 SP. 140512	42	32	44	213	126	153	60			
HTUM 43XD3 SP. 140512	43	32	44	216	129	156	60			
HTUM 44XD3 SP. 140512	44	32	44	219	132	159	60			
HTUM 45XD3 SP. 140512	45	40	54	237	135	167	70			
HTUM 46XD3 SP. 140512	46	40	54	240	138	170	70			
HTUM 47XD3 SP. 140512	47	40	54	243	141	173	70			
HTUM 48XD3 SP. 140512	48	40	54	246	144	176	70			
HTUM 49XD3 SP. 140512	49	40	54	249	147	179	70			
HTUM 50XD3 SP. 140512	50	40	54	252	150	182	70			
HTUM 51XD3 SP. 140512	51	40	54	255	153	185	70			
HTUM 52XD3 SP. 140512	52	40	54	258	156	188	70			







 Takım Kodu Ordering Code Bestell-Bezeichnung	Takım Ölçüleri (mm) Dimension (mm) Abmessung (mm)							Kesici Uç Insert Wendeschnei-Platte	Sıkma Vidası Screw Schraube	Anahtar Allen Key Torx Schlüssel
	DC	DCON	DCSFMS	OAL	LU	LPR	LS			
HTUM 12.5XD4 SP..050204	12.5	20	25	122	50	72	50	SP..050204		HTA-T06
HTUM 13XD4 SP..050204	13	20	25	124	52	74	50			
HTUM 13.5XD4 SP..050204	13.5	20	25	126	54	76	50			
HTUM 14XD4 SP..050204	14	20	25	128	56	78	50			
HTUM 14.5XD4 SP..050204	14.5	20	25	130	58	80	50			
HTUM 15XD4 SP..050204	15	20	25	132	60	82	50			
HTUM 15.5XD4 SP..060204	15.5	20	25	134	62	84	50	SP..060204		HTA-T07
HTUM 16XD4 SP..060204	16	25	34	142	64	86	56			
HTUM 16.5XD4 SP..060204	16.5	25	34	144	66	88	56			
HTUM 17XD4 SP..060204	17	25	34	146	68	90	56			
HTUM 17.5XD4 SP..060204	17.5	25	34	148	70	92	56			
HTUM 18XD4 SP..060204	18	25	34	150	72	94	56			
HTUM 18.5XD4 SP..060204	18.5	25	34	152	74	96	56			
HTUM 19XD4 SP..060204	19	25	34	154	76	98	56			
HTUM 19.5XD4 SP..060204	19.5	25	34	154	76	98	56			
HTUM 20XD4 SP..060204	20	25	34	158	80	102	56			
HTUM 20.5XD4 SP..060204	20.5	25	34	160	82	104	56			
HTUM 21XD4 SP..060204	21	25	34	162	84	106	56			
HTUM 21.5XD4 SP..060204	21.5	25	34	164	86	108	56			
HTUM 22XD4 SP..07T308	22	25	34	166	88	110	56	SP..07T308		HTA-T08
HTUM 22.5XD4 SP..07T308	22.5	25	34	168	90	112	56			
HTUM 23XD4 SP..07T308	23	25	34	170	92	114	56			
HTUM 23.5XD4 SP..07T308	23.5	25	34	170	92	114	56			
HTUM 24XD4 SP..07T308	24	25	34	174	96	118	56			
HTUM 24.5XD4 SP..07T308	24.5	25	34	176	98	120	56			
HTUM 25XD4 SP..07T308	25	25	34	178	100	122	56			
HTUM 25.5XD4 SP..07T308	25.5	25	34	180	102	124	56			
HTUM 26XD4 SP..07T308	26	25	34	182	104	126	56			
HTUM 26.5XD4 SP..07T308	26.5	25	34	184	106	128	56			
HTUM 27XD4 SP..07T308	27	25	34	186	108	130	56			
HTUM 27.5XD4 SP..07T308	27.5	25	34	186	108	130	56			

 Takım Kodu Ordering Code Bestell-Bezeichnung	Takım Ölçüleri (mm) Dimension (mm) Abmessung (mm)							Kesici Uç Insert Wendeschnei Platte	Sıkma Vidası Screw Schrauble	Anahtar Allen Key Torx Schlüssel
	DC	DCON	DCSFMS	OAL	LU	LPR	LS			
HTUM 28XD4 SP. 090408	28	25	34	190	112	134	56	SP. 090408	1060-M3.5x9	HTA-T15
HTUM 28.5XD4 SP. 090408	28.5	25	34	192	114	136	56			
HTUM 29XD4 SP. 090408	29	25	34	194	116	138	56			
HTUM 29.5XD4 SP. 090408	29.5	25	34	196	118	140	56			
HTUM 30XD4 SP. 090408	30	32	44	207	120	147	60			
HTUM 31XD4 SP. 090408	31	32	44	211	124	151	60			
HTUM 32XD4 SP. 090408	32	32	44	215	128	155	60			
HTUM 33XD4 SP. 090408	33	32	44	219	132	159	60	SP. 110408	1060-M4x11	HTA-T15
HTUM 34XD4 SP. 110408	34	32	44	223	136	163	60			
HTUM 35XD4 SP. 110408	35	32	44	227	140	167	60			
HTUM 36XD4 SP. 110408	36	32	44	231	144	171	60			
HTUM 37XD4 SP. 110408	37	32	44	235	148	175	60			
HTUM 38XD4 SP. 110408	38	32	44	239	152	179	60			
HTUM 39XD4 SP. 110408	39	32	44	243	156	183	60			
HTUM 40XD4 SP. 110408	40	32	44	247	160	187	60	SP. 140512	1060-M5x11	HTA-T20
HTUM 41XD4 SP. 110408	41	32	44	251	164	191	60			
HTUM 42XD4 SP. 140512	42	32	44	255	168	195	60			
HTUM 43XD4 SP. 140512	43	32	44	259	172	199	60			
HTUM 44XD4 SP. 140512	44	32	44	263	176	203	60			
HTUM 45XD4 SP. 140512	45	40	54	282	180	212	70			
HTUM 46XD4 SP. 140512	46	40	54	286	184	216	70			

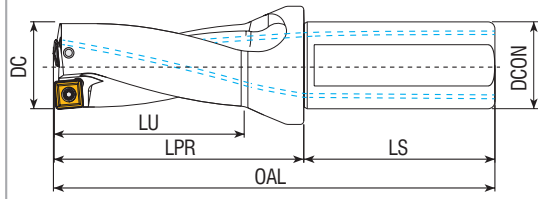







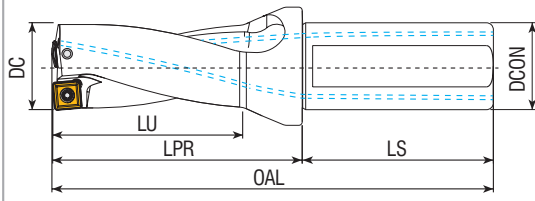
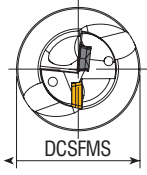

 Takım Kodu Ordering Code Bestell-Bezeichnung	Takım Ölçüleri (mm) Dimension (mm) Abmessung (mm)							Kesici Uç Insert Wendeschnei Platte	Sıkma Vidası Screw Schraube	Anahtar Allen Key Torx Schlüssel
	DC	DCON	DCSFMS	OAL	LU	LPR	LS			
HTUM 13XD5 SP..050204	13	20	25	137	65	87	50	SP..050204		HTA-T06
HTUM 14XD5 SP..050204	14	20	25	142	70	92	50			
HTUM 15XD5 SP..050204	15	20	25	147	75	97	50			
HTUM 16XD5 SP..060204	16	25	34	158	80	102	56	SP..060204		HTA-T07
HTUM 17XD5 SP..060204	17	25	34	163	85	107	56			
HTUM 18XD5 SP..060204	18	25	34	168	90	112	56			
HTUM 19XD5 SP..060204	19	25	34	173	95	117	56			
HTUM 20XD5 SP..060204	20	25	34	178	100	122	56			
HTUM 21XD5 SP..060204	21	25	34	183	105	127	56			
HTUM 22XD5 SP..07T308	22	25	34	188	110	132	56	SP..07T308		HTA-T08
HTUM 23XD5 SP..07T308	23	25	34	193	115	137	56			
HTUM 24XD5 SP..07T308	24	25	34	198	120	142	56			
HTUM 25XD5 SP..07T308	25	25	34	203	125	147	56			
HTUM 26XD5 SP..07T308	26	25	34	208	130	152	56			
HTUM 27XD5 SP..07T308	27	25	34	213	135	157	56			
HTUM 28XD5 SP..090408	28	25	44	227	140	167	60	SP..090408		HTA-T15
HTUM 29XD5 SP..090408	29	25	44	232	145	172	60			
HTUM 30XD5 SP..090408	30	32	44	237	150	177	60			







 Takım Kodu Ordering Code Bestell-Bezeichnung	Takım Ölçüleri (mm) Dimension (mm) Abmessung (mm)							Kesici Uç Insert Wendeschnei-Platte	Sıkma Vidası Screw Schraube	Anahtar Allen Key Torx Schlüssel
	DC	DCON	DCSFMS	OAL	LU	LPR	LS			
HTUM 14XD2 KDR 0502..	14	20	25	100	28	50	50	SPMT 050204- XOMT 050204	1060-M2x4	HTA-T06
HTUM 15XD2 KDR 0502..	15	20	25	102	30	52	50			
HTUM 16XD2 KDR 0502..	16	25	34	110	32	54	56			
HTUM 17XD2 KDR 0602..	17	25	34	112	34	56	56	SPMT 060205- XOMT 060204	1060-M2.2x5	HTA-T07
HTUM 18XD2 KDR 0602..	18	25	34	114	36	58	56			
HTUM 19XD2 KDR 0602..	19	25	34	116	38	60	56			
HTUM 20XD2 KDR 07T2..	20	25	34	118	40	62	56	"SPMT 07T208 XOMT 07T205"	1060-M2.5x7	HTA-T08
HTUM 21XD2 KDR 07T2..	21	25	34	120	42	64	56			
HTUM 22XD2 KDR 07T2..	22	25	34	122	44	66	56			
HTUM 23XD2 KDR 07T2..	23	25	34	124	46	68	56	"SPMT 090308 XOMT 090305"	1060-M3x8	HTA-T08
HTUM 24XD2 KDR 0903..	24	25	34	126	48	70	56			
HTUM 25XD2 KDR 0903..	25	25	34	128	50	72	56			
HTUM 26XD2 KDR 0903..	26	25	34	130	52	74	56			
HTUM 27XD2 KDR 0903..	27	25	34	132	54	76	56			
HTUM 28XD2 KDR 0903..	28	25	34	134	56	78	56			
HTUM 29XD2 KDR 0903..	29	25	34	136	58	80	56	"SPMT 11T308 XOMT 11T306"	1060-M3.5x9	HTA-T15
HTUM 30XD2 KDR 11T3..	30	32	44	147	60	87	60			

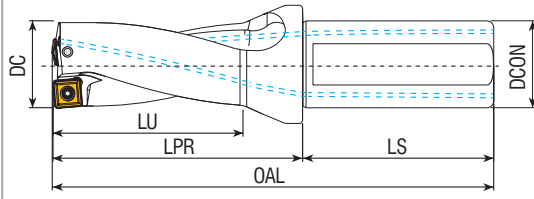
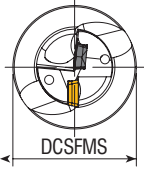

 Takım Kodu Ordering Code Bestell-Bezeichnung	Takım Ölçüleri (mm) Dimension (mm) Abmessung (mm)							Kesici Uç Insert Wendschnei-Platte	Sıkma Vidası Screw Schraube	Anahtar Allen Key Torx Schlüssel
	DC	DCON	DCSFMS	OAL	LU	LPR	LS			
HTUM 12.5XD3 KDR 0402..	12.5	20	25	108	36	58	50	"SPMT 040204 XOMT 040204"	1060-M2x4	
HTUM 13XD3 KDR 0402..	13	20	25	111	39	61	50			
HTUM 13.5XD3 KDR 0402..	13.5	20	25	111	39	61	50			
HTUM 14XD3 KDR 0502..	14	20	25	114	42	64	50	SPMT 050204- XOMT 050204	1060-M2x4	HTA-T06
HTUM 14.5XD3 KDR 0502..	14.5	20	25	114	42	64	50			
HTUM 15XD3 KDR 0502..	15	20	25	117	45	67	50			
HTUM 15.5XD3 KDR 0502..	15.5	20	25	117	45	67	50			
HTUM 16XD3 KDR 0502..	16	25	34	126	48	70	56			
HTUM 16.5XD3 KDR 0602..	16.5	25	34	126	48	70	56	SPMT 060205- XOMT 060204	1060-M2.2x5	HTA-T07
HTUM 17XD3 KDR 0602..	17	25	34	129	51	73	56			
HTUM 17.5XD3 KDR 0602..	17.5	25	34	129	51	73	56			
HTUM 18XD3 KDR 0602..	18	25	34	132	54	76	56			
HTUM 18.5XD3 KDR 0602..	18.5	25	34	132	54	76	56			
HTUM 19XD3 KDR 0602..	19	25	34	135	57	79	56			
HTUM 19.5XD3 KDR 0602..	19.5	25	34	135	57	79	56	"SPMT 07T208 XOMT 07T205"	1060-M2.5x7	
HTUM 20XD3 KDR 07T2..	20	25	34	138	60	82	56			
HTUM 20.5XD3 KDR 07T2..	20.5	25	34	138	60	82	56			
HTUM 21XD3 KDR 07T2..	21	25	34	141	63	85	56			
HTUM 21.5XD3 KDR 07T2..	21.5	25	34	141	63	85	56			
HTUM 22XD3 KDR 07T2..	22	25	34	144	66	88	56			
HTUM 22.5XD3 KDR 07T2..	22.5	25	34	144	66	88	56			
HTUM 23XD3 KDR 07T2..	23	25	34	147	69	91	56	"SPMT 090308 XOMT 090305"	1060-M3x8	HTA-T08
HTUM 23.5XD3 KDR 07T2..	23.5	25	34	147	69	91	56			
HTUM 24XD3 KDR 0903..	24	25	34	150	72	94	56			
HTUM 24.5XD3 KDR 0903..	24.5	25	34	150	72	94	56			
HTUM 25XD3 KDR 0903..	25	25	34	153	75	97	56			
HTUM 25.5XD3 KDR 0903..	25.5	25	34	153	75	97	56			
HTUM 26XD3 KDR 0903..	26	25	34	156	78	100	56			
HTUM 26.5XD3 KDR 0903..	26.5	25	34	156	78	100	56			
HTUM 27XD3 KDR 0903..	27	25	34	159	81	103	56			
HTUM 27.5XD3 KDR 0903..	27.5	25	34	159	81	103	56			
HTUM 28XD3 KDR 0903..	28	25	34	162	84	106	56			
HTUM 28.5XD3 KDR 0903..	28.5	25	34	162	84	106	56			
HTUM 29XD3 KDR 0903..	29	25	34	165	87	109	56			
HTUM 29.5XD3 KDR 0903..	29.5	25	34	165	87	109	56			





 Takım Kodu Ordering Code Bestell-Bezeichnung	Takım Ölçüleri (mm) Dimension (mm) Abmessung (mm)							Kesici Uç Insert Wendeschnei Platte	Sıkma Vidası Screw Schraube	Anahtar Allen Key Torx Schlüssel
	DC	DCON	DCSFMS	OAL	LU	LPR	LS			
HTUM 30XD3 KDR 11T3..	30	32	44	177	90	117	60	"SPMT 11T308 XOMT 11T306"	1060-M3.5x9	HTA-T15
HTUM 31XD3 KDR 11T3..	31	32	44	180	93	120	60			
HTUM 32XD3 KDR 11T3..	32	32	44	183	96	123	60			
HTUM 33XD3 KDR 11T3..	33	32	44	186	99	126	60			
HTUM 34XD3 KDR 11T3..	34	32	44	189	102	129	60			
HTUM 35XD3 KDR 11T3..	35	32	44	192	105	132	60	SPMT 130410 - XOMT 130406	1060-M4x11	
HTUM 36XD3 KDR 1304..	36	32	44	195	108	135	60			
HTUM 37XD3 KDR 1304..	37	32	44	198	111	138	60			
HTUM 38XD3 KDR 1304..	38	32	44	201	114	141	60			
HTUM 39XD3 KDR 1304..	39	32	44	204	117	144	60			
HTUM 40XD3 KDR 1304..	40	32	44	207	120	147	60			

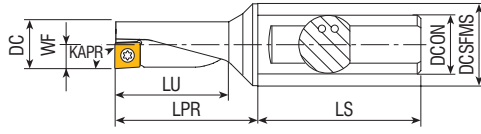
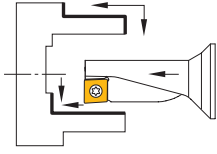

 Takım Kodu Ordering Code Bestell-Bezeichnung	Takım Ölçüleri (mm) Dimension (mm) Abmessung (mm)							Kesici Uç Insert Wendeschnei-Platte	Sıkma Vidası Screw Schraube	Anahtar Allen Key Torx Schlüssel
	DC	DCON	DCSFMS	OAL	LU	LPR	LS			
HTUM 12.5XD4 KDR 0402..	12.5	20	25	122	50	70	50	"SPMT 040204 XOMT 040204"	1060-M2x4	
HTUM 13XD4 KDR 0402..	13	20	25	124	52	72	50			
HTUM 13.5XD4 KDR 0402..	13.5	20	25	124	54	74	50			
HTUM 14XD4 KDR 0502..	14	20	25	128	56	76	50	SPMT 050204- XOMT 050204	1060-M2x4	HTA-T06
HTUM 14.5XD4 KDR 0502..	14.5	20	25	128	58	78	50			
HTUM 15XD4 KDR 0502..	15	20	25	132	60	80	50			
HTUM 15.5XD4 KDR 0502..	15.5	25	25	132	62	84	50			
HTUM 16XD4 KDR 0502..	16	25	34	142	64	86	56			
HTUM 16.5XD4 KDR 0602..	16.5	25	34	142	66	88	56	SPMT 060205- XOMT 060204	1060-M2.2x5	HTA-T07
HTUM 17XD4 KDR 0602..	17	25	34	146	68	90	56			
HTUM 17.5XD4 KDR 0602..	17.5	25	34	146	70	92	56			
HTUM 18XD4 KDR 0602..	18	25	34	150	72	94	56			
HTUM 18.5XD4 KDR 0602..	18.5	25	34	150	74	96	56			
HTUM 19XD4 KDR 0602..	19	25	34	154	76	98	56			
HTUM 19.5XD4 KDR 0602..	19.5	25	34	154	78	100	56	"SPMT 07T208 XOMT 07T205"	1060-M2.5x7	HTA-T08
HTUM 20XD4 KDR 07T2..	20	25	34	158	80	102	56			
HTUM 20.5XD4 KDR 07T2..	20.5	25	34	158	82	104	56			
HTUM 21XD4 KDR 07T2..	21	25	34	162	84	106	56			
HTUM 21.5XD4 KDR 07T2..	21.5	25	34	162	86	108	56			
HTUM 22XD4 KDR 07T2..	22	25	34	166	88	110	56			
HTUM 22.5XD4 KDR 07T2..	22.5	25	34	166	90	112	56			
HTUM 23XD4 KDR 07T2..	23	25	34	170	92	114	56	"SPMT 090308 XOMT 090305"	1060-M3x8	HTA-T08
HTUM 23.5XD4 KDR 07T2..	23.5	25	34	170	94	116	56			
HTUM 24XD4 KDR 0903..	24	25	34	174	96	118	56			
HTUM 24.5XD4 KDR 0903..	24.5	25	34	174	98	120	56			
HTUM 25XD4 KDR 0903..	25	25	34	178	100	122	56			
HTUM 25.5XD4 KDR 0903..	25.5	25	34	178	102	124	56			
HTUM 26XD4 KDR 0903..	26	25	34	182	104	126	56			
HTUM 26.5XD4 KDR 0903..	26.5	25	34	182	106	128	56			
HTUM 27XD4 KDR 0903..	27	25	34	186	108	130	56			
HTUM 27.5XD4 KDR 0903..	27.5	25	34	186	110	132	56			
HTUM 28XD4 KDR 0903..	28	25	34	190	112	134	56	"SPMT 11T308 - XOMT 11T306"		
HTUM 28.5XD4 KDR 0903..	28.5	25	34	190	114	136	56			
HTUM 29XD4 KDR 0903..	29	25	34	194	116	138	56			
HTUM 29.5XD4 KDR 0903..	29.5	25	34	194	118	140	56			
HTUM 30XD4 KDR 0903..	30	32	44	207	120	147	60			





 Takım Kodu Ordering Code Bestell-Bezeichnung	Takım Ölçüleri (mm) Dimension (mm) Abmessung (mm)							Kesici Uç Insert Wendeschnei Platte	Sıkma Vidası Screw Schraube	Anahtar Allen Key Torx Schlüssel
	DC	DCON	DCSFMS	LU	LPR	LS	WF			
HMCR/L-D2.25X8 XC.. 040104	8	10	12	18	22	38	4	XC.. 040104	1060-M1.8x4	
HMCR/L-D2.25X10 XC.. 050204	10	12	16	22.5	27.5	42	5	XC.. 050204	1060-M2x4	HTA-T06
HMCR/L-D2.25X12 XC.. 060204	12	16	20	27	33	45	6	XC.. 060204	1060-M2.2x5	
HMCR/L-D2.25X14 XC.. 070304	14	16	20	31.5	38	45	7	XC.. 070304	1060-M2.5x6	
HMCR/L-D2.25X16 XC.. 080304	16	20	25	36	44	50	8	XC.. 080304	1060-M3x6	HTA-T08
HMCR/L-D2.25X18 XC.. 09T304	18	25	32	40.5	53.5	56	9	XC.. 09T304		
HMCR/L-D2.25X20 XC.. 10T304	20	25	32	45	55	56	10	XC.. 10T304	1060-M3.5x9	HTA-T15
HMCR/L-D2.25X25 XC.. 130404	25	32	40	56.5	69	60	12.5	XC.. 130404	1060-M4.5x10	HTA-T20
HMCR/L-D2.25X32 XC.. 170504	32	32	50	72	88	60	16	XC.. 170504	1060-M4.5x12	



Takma Uçlu Matkap (U-Drill) Kullanma Kılavuzu

Matkabınızı CNC torna tezgahına bağlamadan önce taretin merkezden kaçık olup olmadığını kontrol etmeniz gerekir. Şayet taretinizde kaçıklık varsa, takma uçlu matkabınızı kesinlikle kullanmayınız. Taretin düzeltilmesi için yapılması gereken işlemler ;

1. Taretin tutucusuna kullanacağınız takma uçlu matkabın çapında ve boyunda üzeri hassas olan silindirik bir parça bağlanır ve tezgahın X değeri sıfıra getirilir.
2. Tezgahın aynasına miknatıslı komprotör saati yerleştirilir. Saatin uç kısmı tarete bağlanmış olduğumuz parçanın üstüne temas ettirilir.
3. Aynanın üzerine bağlanmış olduğumuz miknatıslı komprotör ayna ile beraber 360 derece döndürülerek saatteki değişim oranına göre taretin sıfırlanması sağlanır.

Takma Uçlu Matkabınızı Cnc Tormanızda Daha Verimli Kullanmanız İçin Gerekli Olan Kesme Hızları ve Devirleri

Grup No.	Malzemenin Cinsi	Malzemenin Öz.	Kesme Hızı Vc (m/dk)
1	Çok Yumuşak İş Çelikleri	C1010, Otomat vb.	220
2	İmalat Çelik ve Döküm Malz.	C1030 - 106 vb.	200
3	Takım ve İmalat Çeşitleri	CK-45, 4140, 7131 vb.	170
4	Sıcak İş ve Paslanmaz Çelikler	İmpaks vb.	150

Devir hesabı yapabilmek için önce malzemeyi seçiniz. Seçtiğiniz malzemenin kesme hızını (Vc) 1000 ile çarpıp 3.14'e bölmeliyiz. Çıkan değeri matkap çapına bölmeliyiz. **Örnek:** Malzememiz takım ve imalat çeliği (3. grup), matkap çapı 20 mm kesme hızı 170 ise $170 \times 1000 = 170000 / 3.14 = 54140$, $54140 / 20 = 2707$ devir çıkar (Tezgahın İş Mili Devri). Tezgahın ilerlemesi kullanacağınız uç ile de alakalı olup 0.05 ile 0.10 arasında değişim gösterir. Kullanıcı kesici ucun kesişine göre bunu ayarlar.

İşleme Merkezleri İçin İlerleme Hesabı

Yukarıdaki hesaplamalarla bulmuş olduğunuz 2166 iş mili devrini, kesici uç ilerlemesi (mm/devir) 0.05 ile 0.10 arasındaki ilerleme seçenekleri ile çarpılır.

Örnek 1: $2707 \times 0.05 = 135$

Örnek 2: $2707 \times 0.10 = 270.7$ çıkan sonuçlar 135 ve 270.7 işleme merkezleri için ilerleme mm/dakika hesabıdır.

Not: D4 ve üzeri takma uçlu matkaplarda tezgahın içten su verme basıncının en az 6 bar olması gerekmektedir.

User's Guide For Akko U-Drills

Before connecting your U-Drill to CNC lathe, you have to check if the turret is eccentric from the center or not. If there is any eccentricity in your turret, never use your U-Drill; Processes that should be done to fix the turret :

1. A cylindrical part whose surface is precision and whose length and diameter is the same with the U-Drill that you will use, should be mounted to the holder of turret and X value of the lathe should be brought to zero (0).
2. Comparator should be mounted to chuck. The end of the comparator should be contacted (touched) to the surface of the part that we mounted on the turret.
3. The comparator that we mounted on the chuck should be turned 360-degree with the chuck and turret should be zeroed by that turning according to changing rate of comparator.

Cutting Speed And Revolution That Are Needed For Using (Running) Your U-drills More Productively

Grup No.	Material	Material Type	Cutting Speed Vc (m/m)
1	Non-alloy steel and free cutting steel	C1010. Automat etc.	220
2	Low alloy steel and cast steel	C1030 - 106 etc.	200
3	Alloy steel and tool steel	CK-45, 4140, 7131 etc.	170
4	Hot Work Steel and Stainless Steel	Impax etc.	150

P.S. : The cutting speed may be concerned with the type of the insert that you use.

Fistly, choose the material to make calculation of revolution. You should multiply the cutting speed (Vc) of the material that you chose by 1000 and divide by 3.14. You should divide the value that you found by the diameter of U-Drill. **For Example :** If our material is alloy steel and tool steel (3rd group), diameter of the U-Drill is 20 mm, cutting speed is 170, we should calculate as following; $170 \times 1000 = 170000 / 3.14 = 54140$, $54140 / 20 = 2707$ rpm is the result that we found (Spindle Speed) Feed rate of the lathe is concerned with the U-Drill that you will use and changes between 0.05 and 0.10. The user sets it according to cut of cutting insert.

Feed Calculation For Central Machine

2166 spindle speed, that we found as a result of above mentioned calculation, should be multiplied by cutting insert feed (mm/r) between 0.05 and 0.10 feed choises.

Example 1: $2707 \times 0.05 = 135$

Example 2: $2707 \times 0.10 = 270.7$ The results 135 and 270.7 are the feed mm/m calculation for central machine.

Note: Cooling water pressure of lathe must be minimum 6 bar for our D4 u-drills and u-drills longer than D4.

A Tip - A Type - A Typ

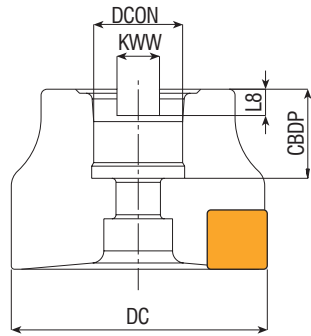

DC	DCON	DBC	KWW	L8	CBDP
40	16	-	8.4	5.6	20
50	22	-	10.4	6.3	22
63	22	-	10.4	6.3	22
80	27	-	12.4	7	25
100	32	-	14.4	8	26

B Tip - B Type - B Typ

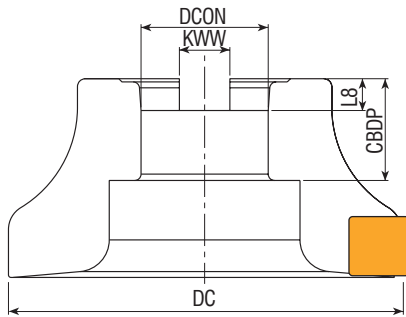

DC	DCON	DBC	KWW	L8	CBDP
125	40	-	16.4	9	32

C Tip - C Type - C Typ

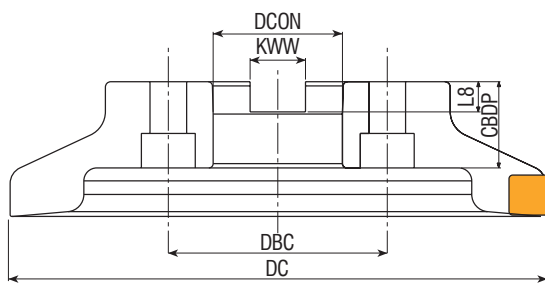

DC	DCON	DBC	KWW	L8	CBDP
160	40	66.7	16.4	9	32
200	60	101.6	25.7	14	40
250	60	101.6	25.7	14	40

D Tip - D Type - D Typ

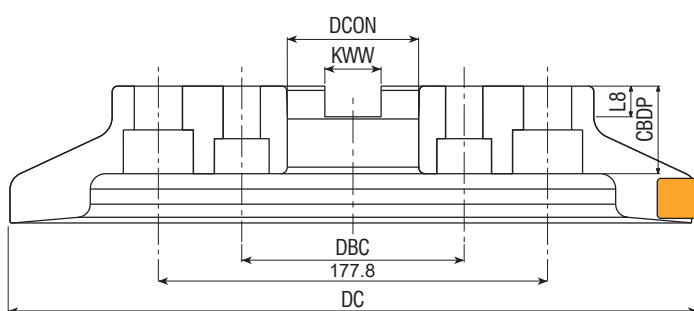

DC	DCON	DBC	KWW	L8	CBDP
315	60	101.6	25.7	14	40

Frezeleme İşleminde Devir ve İlerleme Hesabı

Vc.	S	D	F	Z	fz	Formüller
Kesme Hızı (Uç Kutusunun Arkasından Okuyunuz)	İş Mili Devir Sayısı	Tarama Kafası Çapı	İlerleme	Tarama Kafası Ağız Sayısı	Diş Başına Düşen İlerleme Miktarı (Uç Kutusunun Arkasından Okuyunuz)	Devir Hesabı: $S = (Vc \times 1000) / (3,14 \times D)$ İlerleme Hesabı: $F = S \times Z \times fz$

Örnek: D=63 mm çapında, Z=5 ağızlı tarama kafası ile frezeleme yapacağız. Kesici uç kutusunun arkasında kesme hızı Vc=200m/dk. olarak verilmiş olsun. Tezgaha girilecek devri hesaplayalım: **Vc=200 m/dk. D=63 mm** S = Öncelikle Kesme Hızı 1000 ile çarpılır, çıkan sonuç 3,14 sayısına bölünür, buradan çıkan sonuç da tarama kafası çapına bölünür.

$S = 200 \times 1000 = 200000 \rightarrow 200000 / 3,14 = 63663 \rightarrow 63663 / 63 = 1011$ devir $S = 1011$ dev/dakika devri bulduktan sonra ilerlemeyi bulalım: **Z=5** ağızlı tarama kafası olsun **fz=0,12** olarak uç kutusunun arkasından okunmuş olsun F= yukarıda bulmuş olduğumuz devir sayısı ile ağız sayısı çarpılır, çıkan sonuç diş başına düşen ilerleme miktarı ile çarpılır.

$F = 1011 \times 5 = 5055 \rightarrow 5055 \times 0,12 = 606$ F=606 mm/dakika

Tezgaha girilecek olan devir = **S 1011** Tezgaha girilecek olan ilerleme: **F 606 ortalama değerdir.**

Not: Vc ve fz değerlerinin uç kutusunun arkasında verilmiş olması gerekir. Eğer bu değerler uç kutusunun üzerinde yoksa, kesici ucun kataloğundan bulunuz. İşleyeceğiniz malzeme çelik ise P, paslanmaz çelik ise M, dökme demir ise K bölümünde yazılı olan Vc ve fz değerlerini okuyun.

Calculating Spindle Speed And Feed Rate For Milling Process

Vc.	S	D	F	Z	fz	Formulas
Cutting Speed (Please read from the backside of cutting insert box)	Spindle Revolution (rpm)	Milling Tool Diameter	Feed Rate	Number of Effective Tooth	Feed Per Tooth (Please Read From The Back Side of Cutting Insert Box)	Calculation of Revolution: $S = (Vc \times 1000) / (3,14 \times D)$ Feed Rate Calculation: $F = S \times Z \times fz$

For Example: We will make milling with milling tool whose diameter is D 63 mm, whose teeth number is Z=5. The spindle revolution was written as Vc=200m/mn at the back side of cutting insert box. Let's calculate the revolution that should be entered to the milling machine: **Vc=200 m/mn D=63 mm** S = Firstly Cutting Speed is multiplied with 1000, the result should be divided by 3.14, the last result should be divided by diameter of milling tool.

$S = 200 \times 1000 = 200000 \rightarrow 200000 / 3,14 = 63663 \rightarrow 63663 / 63 = 1011$ rev $S = 1011$ rev / mn After finding spindle revolution, let's find feed rate: milling tool with **Z=5** teeth and we read **fz=0,12** from the back side of cutting insert box. F = Tooth number should be multiplied with revolution, the result should be multiplied with feed per tooth.

$F = 1011 \times 5 = 5055 \rightarrow 5055 \times 0,12 = 606$ F = 606 mm / mn

Revolution that should be entered to the milling machine = **S 1011** Feed Rate that should be entered to the milling machine: **F 606 average value.**

P.S: The values Vc and fz has to be written at the back side of the cutting insert. If these values were not written on the cutting insert box, please find them from cutting insert catalogue. If the material that you will work is steel, please read Vc and fz values that were written on the part P, if it is stainless steel please read from the part M, if it is cast iron please read from the part K.

Berechnung Von Drehzahl Und Vorschub Für Fräswerkzeuge

Vc.	S	D	F	Z	fz	Formeln
Schnittgeschwindigkeit (finden Sie z.B. auf der Verpackung der Wendeschneidplatte)	Spindel Drehzahl	Fräswerkzeug Durchmesser	Vorschubges- chwindigkeit	Anzahl der effektiven Zähne	Vorschub pro Zahn (finden Sie z.B. auf der Verpackung der Wendeschneidplatte)	Devir Hesabı: $S = (Vc \times 1000) / (3,14 \times D)$ İlerleme Hesabı: $F = S \times Z \times fz$















Beispiel: Fräswerkzeug mit D 63 mm und **Z=5**. Schnittgeschwindigkeit vc=200 m/min. (laut Wendeschneidplattenverpackung).

Berechnung der Drehzahl: $n = 200 \text{ m/min.} \times 1000 = 200000 / 3,14 = 63694 / 63 \text{ mm} = 1011 \text{ Umdr./min.}$











Berechnung des Vorschubs: Ermittlung von fz (finden Sie z.B. auf der Verpackung der Wendeschneidplatte), für das Berechnungsbeispiel **fz=0,12** mm $F = n \times Z \times fz = 1011 \times 5 \times 0,12 = 606 \text{ mm/min.}$ D.h., Sie stellen an der Maschine folgende Werte ein: Drehzahl n = 1011 Umdr./ min., **Vorschub F = 606 mm/min.**

P.S: Die Werte für vc und fz finden Sie auf der Rückseite der Wendeschneidplattenverpackung. Sollten diese Werte dort nicht stehen, können Sie diese auch im Wendeschneidplattenkatalog finden. Für Stahl wählen Sie für vc und fz bitte die Werte aus dem Bereich P, für rostfreien Stahl aus dem Bereich M und für Guss aus dem Bereich K.

Altıklar / Shims / Unterlage

Ürün Resmi Product Image Produktbild	Ürün Kodu Product Code Produktcode	Ürün Açıklaması Product Description Produktbeschreibung
	HCCM-09	CCMT 09
	HCCM-12	CCMT 12
	HCNM-12	CNMG 12
	HCNM-16	CNMG 16
	HCNM-19	CNMG 19
	HDCM-11	DCMT 11 / DNMG 11
	HDNM-15	DNMG 15
	HKNR-16	KNUX 16
	HKNL-16	KNUX 16
	HER-16	16 ER/IR
	HER-22	22 ER/IR
	HTER-16	16 TER/TIR
	HTER-22	22 TER/TIR
	HTER-27	27 TER/TIR
	HTEL-16	16 TEL/TIL
	HTEL-22	22 TEL/TIL
	HTEL-27	27 TEL/TIL
	HSCM-09	SCMT 09
	HSCM-12	SCMT 12
	HSNM-12	SNMG 12
	HSNM-15	SNMG 15
	HTCM-16	TCMT 16
	HTNM-16	TNMG 16
	HTNM-22	TNMG 22
	HVBM-16	VBMT 16 / VCMT 16 / VNMG 16
	HWNM-06	WNMG 06
	HWNM-08	WNMG 08

Baskı Pabuçları - Clamps - Spannsprätze

Ürün Resmi Product Image Produktbild	Ürün Kodu Product Code Produktcode	Ürün Açıklaması Product Description Produktbeschreibung
	HBP-01	DNMG 11 / TNMG 16 / WNMG 06
	HBP-02	CNMG 12 / DNMG 15 / SNMG 12 / TNMG 22 / WNMG 08
	HBP-03	VNMG 16
	HBP-04	CNMG 16 / SNMG 15
	HBP-05	WNMG 06
	HBP-06	WNMG 08
	HBP-07	TNMG 16 S20R MTUN. / S20R MTQN. / S20R-S25S MT-N.
	HBP-08	TNMG 16 / TNMG 22
	HBP-20	TPKN / SPKN / OF..
	HBP-09-R	KNUX 16
	HBP-09-L	KNUX 16

Levyeler / Levers / Kniehebel

Ürün Resmi Product Image Produktbild	Ürün Kodu Product Code Produktcode	Ürün Açıklaması Product Description Produktbeschreibung
	HPL-01	S16P PTUNR/L 16
	HPL-02	CNMG 09, DNMG 11, SNMG 09, TNMG 16, WNMG 06
	HPL-03	CNMG 12, SNMG 12, TNMG 22, WNMG 08
	HPL-04	DNMG 15CNMG 16 / SNMG 15
	HPL-05	CNMG 16, SNMG 15
	HPL-06	CNMG 19

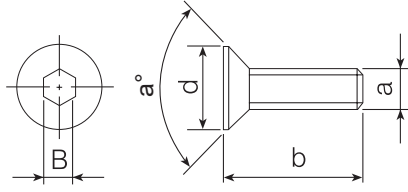

Ürün Kodu
Product Code
Produktcode

Altık Vidalar
Shim Screws
Schraube Für Unterlage

	a (M)	b	d	B	a°
HAV-01-M3*10	M3X0.5	10	5.9	2	45°
HAV-02-M5*12	M5X0.8	12	7	3	45°
HAV-03-M5*8	M5X0.8	9	6.5	3	45°
HAV-04-M5*8	M5X0.8	8	7	3	45°
HAV-05-M6*15	M6X1.0	15	9	4	45°
HAV-06-M5*12	M5X0.8	12	6	3	45°

Ürün Detayı
Product Detail
Produkt-Detaİls

WNMG 06 / KNUX 16
CNMG 12 / DNMG 15 / SNMG 12 / TNMG 22 / WNMG 08 / TNMG 16
CNMG 09 / DNMG 11 / VNMG 16
S25S CNMG 12 / DNMG 15 / SNMG 12 / WNMG 08
CNMG 16, SNMG 15
TNMG 16

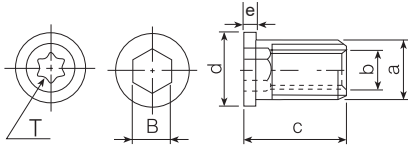

Ürün Kodu
Product Code
Produktcode

Bukse Vidalar
Bukse Screws
Schraube Für Unterlag

	a (M)	b	c	d	B(T)	e
HBV-01-M3.5x8	M5X0.5	M3.5x0.6	8	6	20	1.2
HBV-02-M3.5x11	M5x0.5	M3.5x0.6	11	6	3.5	1.2
HBV-03-M4.5x8	M6X0.75	M4.5X0.75	8	7.5	4.5	1.0
HBV-04-M4.5x13	M6X0.75	M4.5X0.75	13	7.5	4.5	1.6

Ürün Detayı
Product Detail
Produkt-Detaİls

CCMT 09 / DCMT 11 / SCMT 09 / TCMT 16 / VBMT 16 / VCMT 16
CCMT 09 / DCMT 11 / SCMT 09 / TCMT 16 / VBMT 16 / VCMT 16 / 16 ER/IR
CCMT 12 / SCMT 12 / TCMT 16
CCMT 12 / SCMT 12 / 22 ER/IR / 27 ER/IR

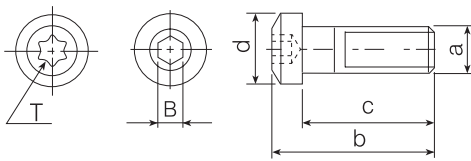

Ürün Kodu
Product Code
Produktcode

Baskı Pabuç Vidaları
Clamp Screws
Schrauben Für Pratze

	a (M)	b	c	d	B(T)
HPV-01-M5*22	M5x0.8	25.1	22	11	3
HPV-02-M6*22	M6x1.0	25.3	22	11	3
HPV-03-M7*25	M7X1.0	29.6	25	14	4
HPV-04-M5*15	M5X0.8	18	15	8.55	3
HPV-05-M6*22	M6x1.0	26.5	20	10.6	4
HPV-20-M8x1x18	M8x1.0	18	8	8	4

Ürün Detayı
Product Detail
Produkt-Detaİls

DNMG 11 / TNMG 16 / WNMG 06
CNMG 12 / DNMG 15 / SNMG 12 / TNMG 22 / TNMG 16 / VNMG 16 / WNMG 08
CNMG 16 / SNMG 15
WNMG 06 / TNMG 16
KNUX 16
TPKN / SPKN / OF.

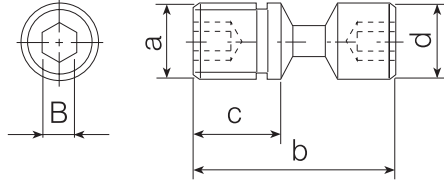

Ürün Kodu
Product Code
Produktcode

Levy Vidalan
Lever Screws
Schrauben Für Kniehebe

	a (M)	b	c	d	B
HLV-01-M6x13	M6X0.1	12.6	6.5	5.9	2.5
HLV-02-M6x14	M6x1.0	14	10	5.85	2.5
HLV-03-M6x17	M6x1.0	17	10	5.85	2.5
HLV-04-M8x16	M8X1.0	16	10	7.9	3
HLV-05-M8x19	M8X1.0	19.8	11	7.9	3
HLV-06-M8x22	M8X1.0	21.5	13	7.75	3
HLV-07-M10x27	M10X1.0	27.5	15	9.9	4

Ürün Detayı
Product Detail
Produkt-Details

S16P PTUNR/L 16
S20R PDUNR/L 11, S20R PDQNR/L 11, S20R PWLNR/L 06, S20R PTUNR/L 16
DNMG 11 / WNMG 06 / TNMG 16
S25S PCLNR/L 12, S25S PDUNR/L 15, S25S PSKNR/L 12
CNMG 12 / DNMG 15 / SNMG 12 / TNMG 22 / WNMG 08
CNMG 16 / SNMG 15
CNMG 19

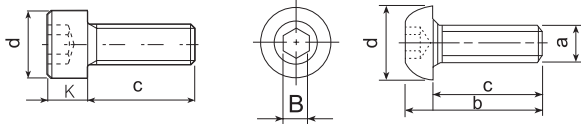

Ürün Kodu
Product Code
Produktcode

Kanal Kater Vidalan
Channel Holder Screws
Kanalhalterschrauben

	a (M)	b	c	d	B	K
HKV-01-M4x10	M4x0.7	-	10	6.85	3	4
HKV-02-M4x12	M4x0.7	-	12	6.85	3	4
HKV-03-M5x12	M5X0.8	-	12	8.5	4	5
HKV-04-M5x16	M5X0.8	-	16	8.5	4	5
HPV-02-M6*22	M6X1	-	20	9.9	5	6
HKV-06-M8x1x20	M8X1.0	25.9	20	11.3	4	-

Ürün Detayı
Product Detail
Produkt-Details

Kanal Kater Vidalan / Channel Holder Screws / Kanalhalterschrauben
Kanal Kater Vidalan / Channel Holder Screws / Kanalhalterschrauben
Kanal Kater Vidalan / Channel Holder Screws / Kanalhalterschrauben
Kanal Kater Vidalan / Channel Holder Screws / Kanalhalterschrauben
Kanal Kater Vidalan / Channel Holder Screws / Kanalhalterschrauben
Kanal Kater Vidalan / Channel Holder Screws / Kanalhalterschrauben

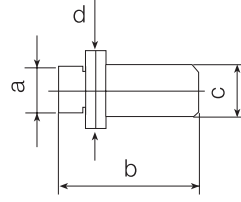

 Ürün Kodu Product Code Produktcode	Pimler Pins Stift				Ürün Detayı Product Detail Produkt-Details
	a	b	c	d	
HPM-01	3,55	18	5	6	TNMG 16
HPM-02	5	18	6	7,3	TNMG 22 / WNMG 08
HPM-03	3,5	12	5	5,4	WNMG 06
HPM-04	3,5	11	5	6,5	TNMG 16
HPM-05	3,5	10	5	5,4	WNMG 06
HPM-06	5	15	6	7,3	WNMG 08
HPM-07	3,55	15	5	6	TNMG 16

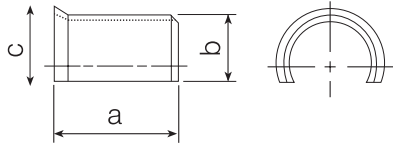

 Ürün Kodu Product Code Produktcode	Altık Yayları Shim Springs Befestigungsfeder			Ürün Detayı Product Detail Produkt-Details
	a	b	c	
HSC-01	5,6	4,9	6	S16P TNMG 16
HSC-02	5,6	4,9	6	DNMG 11, SNMG 09, TNMG 16, WNMG 06
HSC-03	6	6,9	7,9	CNMG 12, SNMG 12, TNMG 22, WNMG 08, DNMG 15
HSC-04	8,9	8	9,5	CNMG 16, SNMG 15
HSC-05	11	9,8	10,7	CNMG 19

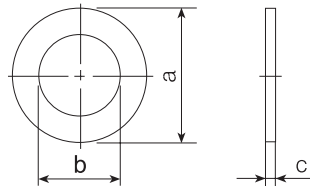

 Ürün Kodu Product Code Produktcode	Baskı Vidasi Pulu Pressure Screw Washer Druckschraube Unterlegscheibe			Ürün Detayı Product Detail Produkt-Details
	a	b	c	
HP-01	10,5	6,2	0,5	CNMG 12 / DNMG 11 / DNMG 15 / SNMG 12 / TNMG 16 / TNMG 22 / VNMG 16 / WNMG 06 / WNMG 08 / KNUX 16
HP-02	12,75	7,1	0,45	CNMG 16 / SNMG 15

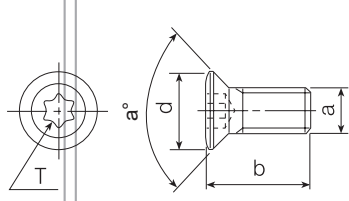

Ürün Kodu
Product Code
Produktcode



Tork Vidaları
Torx Screws
Torx-Schraub

1060-M1.6x3.2	Tork Vidası / Torx Screw / Torx-Schraub
1060-M1.8x4	Tork Vidası / Torx Screw / Torx-Schraub
1060-M2x4	Tork Vidası / Torx Screw / Torx-Schraub
1060-M2.2x5	Tork Vidası / Torx Screw / Torx-Schraub
1060-M2.5x5	Tork Vidası / Torx Screw / Torx-Schraub
1060-M2.5x6	Tork Vidası / Torx Screw / Torx-Schraub
1060-M2.5x7	Tork Vidası / Torx Screw / Torx-Schraub
1070-M3x6	Tork Vidası / Torx Screw / Torx-Schraub
1070-M3x6.8	Tork Vidası / Torx Screw / Torx-Schraub
1060-M3x6	Tork Vidası / Torx Screw / Torx-Schraub
1060-M3x8	Tork Vidası / Torx Screw / Torx-Schraub
1070-M3.5x8	Tork Vidası / Torx Screw / Torx-Schraub
1070-M3.5x9	Tork Vidası / Torx Screw / Torx-Schraub
1060-M3.5x9	Tork Vidası / Torx Screw / Torx-Schraub
1060-M3.5x11	Tork Vidası / Torx Screw / Torx-Schraub
1060-M3.5x12	Tork Vidası / Torx Screw / Torx-Schraub
1070-M3.5x12	Tork Vidası / Torx Screw / Torx-Schraub
1060-M3.5x14	Tork Vidası / Torx Screw / Torx-Schraub
1060-M4x9	Tork Vidası / Torx Screw / Torx-Schraub
1070-M4x9	Tork Vidası / Torx Screw / Torx-Schraub
1060-M4x11	Tork Vidası / Torx Screw / Torx-Schraub
1080-M4x11	Tork Vidası / Torx Screw / Torx-Schraub
1060-M4x12	Tork Vidası / Torx Screw / Torx-Schraub
1070-M4x12	Tork Vidası / Torx Screw / Torx-Schraub
1075-M4x12	Tork Vidası / Torx Screw / Torx-Schraub
1060-M4x14	Tork Vidası / Torx Screw / Torx-Schraub
1060-M4.5x10	Tork Vidası / Torx Screw / Torx-Schraub
1060-M4.5x12	Tork Vidası / Torx Screw / Torx-Schraub
1060-M4.5x16	Tork Vidası / Torx Screw / Torx-Schraub
1060-M5x11	Tork Vidası / Torx Screw / Torx-Schraub
1060-M5x12	Tork Vidası / Torx Screw / Torx-Schraub
1060-M5x14	Tork Vidası / Torx Screw / Torx-Schraub
1060-M5x18	Tork Vidası / Torx Screw / Torx-Schraub
1060-M6x16	Tork Vidası / Torx Screw / Torx-Schraub



Ürün Kodu
Product Code
Produktcode

Alyan Anahtarları
Allen Keys
Innensechskant-Schlüssel

HAL-02	2 mm Alyan Anahtar / Allen Keys / Innensechskant-Schlüssel
HAL-2.5	2,5 mm Alyan Anahtar / Allen Keys / Innensechskant-Schlüssel
HAL-03	3 mm Alyan Anahtar / Allen Keys / Innensechskant-Schlüssel
HAL-3.5	3,5 mm Alyan Anahtar / Allen Keys / Innensechskant-Schlüssel
HAL-04	4 mm Alyan Anahtar / Allen Keys / Innensechskant-Schlüssel
HAL-4.5	4,5 mm Alyan Anahtar / Allen Keys / Innensechskant-Schlüssel
HAL-05	5 mm Alyan Anahtar / Allen Keys / Innensechskant-Schlüssel
HAL-06	6 mm Alyan Anahtar / Allen Keys / Innensechskant-Schlüssel



Ürün Kodu
Product Code
Produktcode

Tork Anahtarları
Torx Keys
Torx-Schlüssel

HTA-T06	T06 Tork Anahtar / Torx Key / Torx-Schlüssel
HTA-T07	T07 Tork Anahtar / Torx Key / Torx-Schlüssel
HTA-T08	T08 Tork Anahtar / Torx Key / Torx-Schlüssel
HTA-T10	T10 Tork Anahtar / Torx Key / Torx-Schlüssel
HTA-T15	T15 Tork Anahtar / Torx Key / Torx-Schlüssel
HTA-T20	T20 Tork Anahtar / Torx Key / Torx-Schlüssel

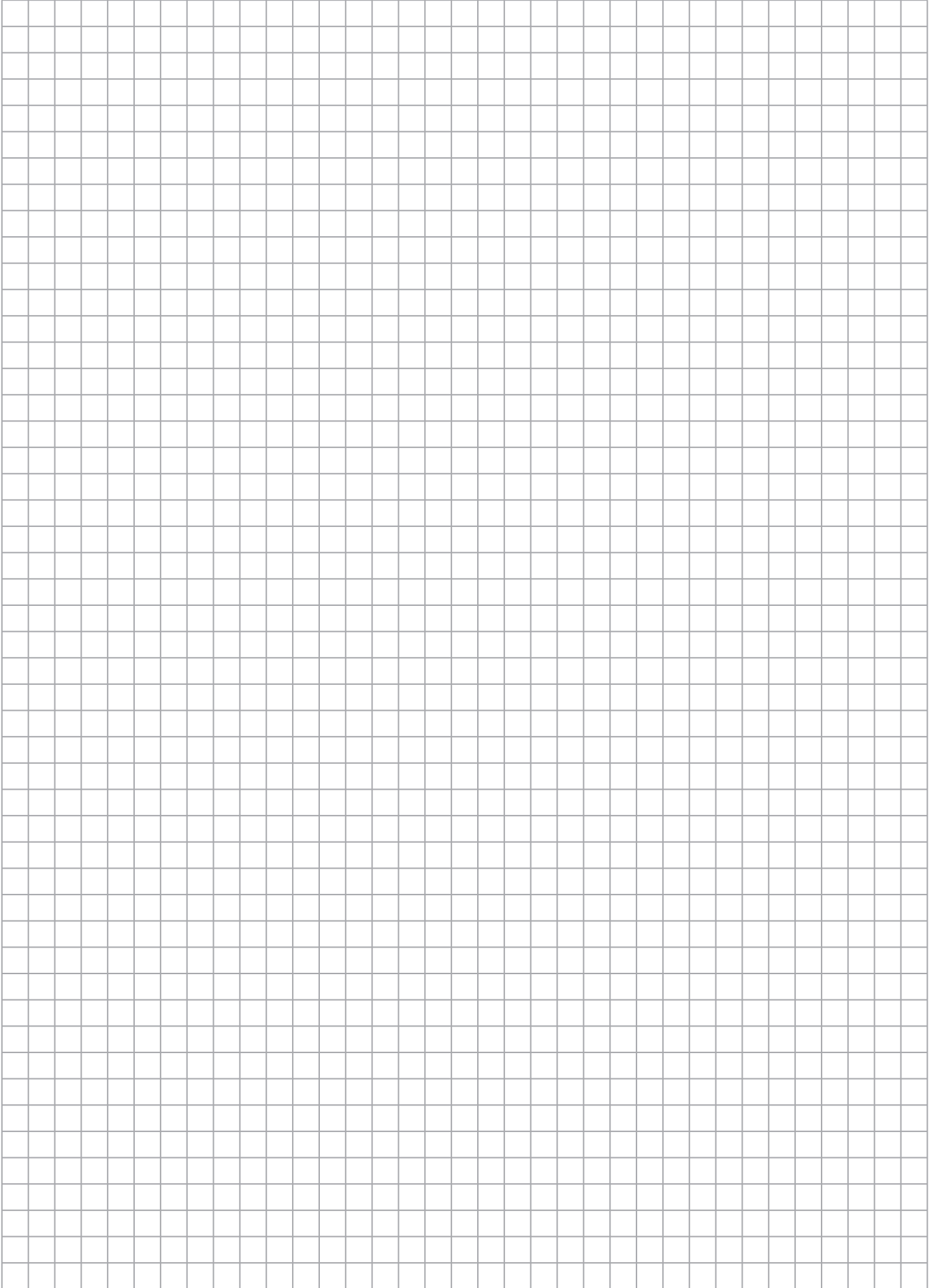

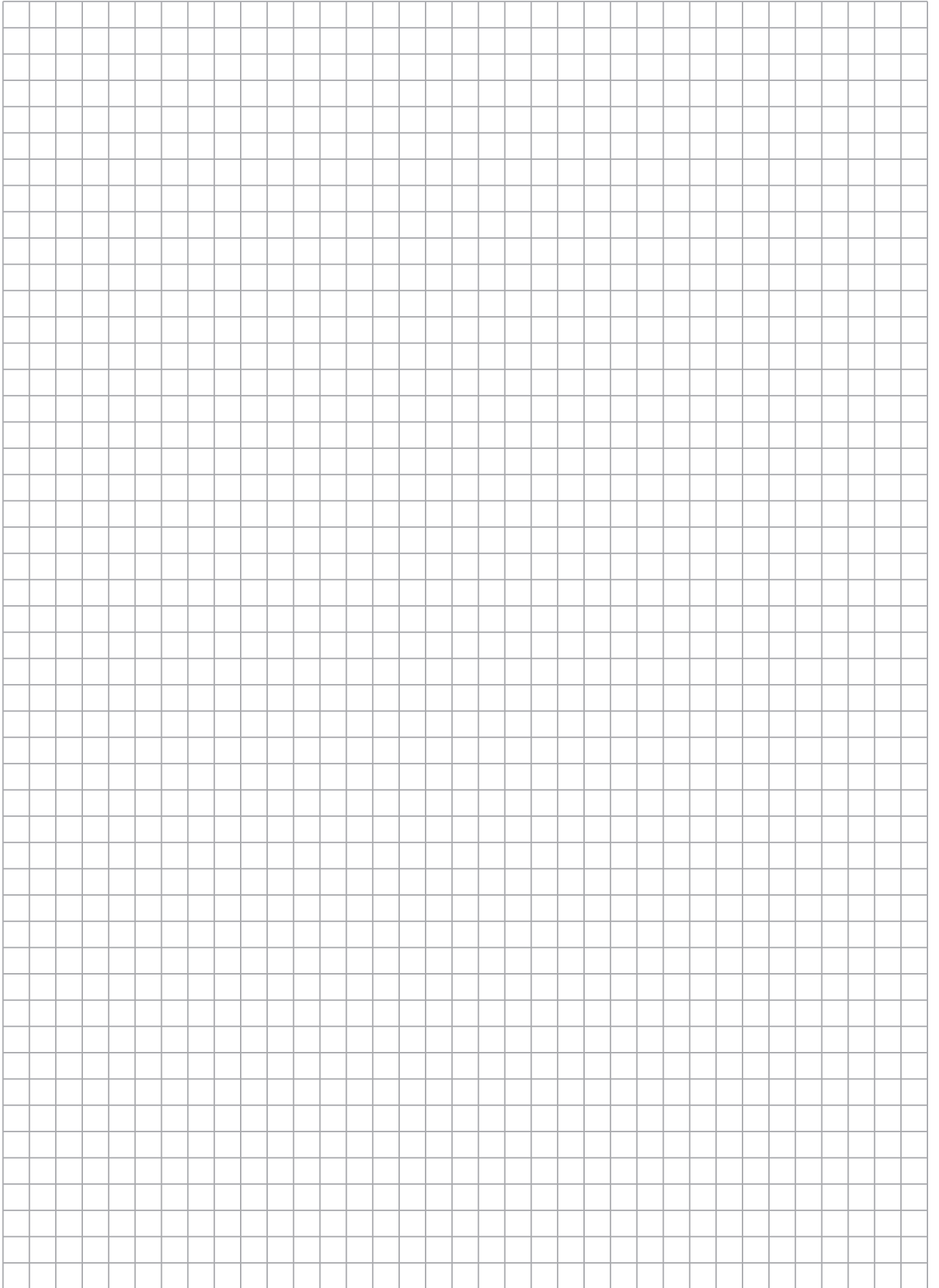

huscut
cutting tools



Huscut Makina İmalat San. ve Tic. Ltd. Şti.

Fevzi Çakmak Mh. 10576 Sk. B Blok No:13/E Karatay/KONYA

+90 332 342 10 30

info@huscut.com.tr

www.huscut.com.tr